

# GENUINE ALUMINUM ACCEL PEDAL (for AT/MT vehicle)

## INSTALLATION (INSTRUCTION) MANUAL

APPLIED VEHICLE: RX-8, MX-5  
PART NUMBER: F151 V8 221

Thank you for purchasing genuine Mazda accessories.

Before installing, be sure to read through this manual.

In order to maintain the optimum condition, read this manual carefully and familiarize yourself with this product prior to the operation.

### <CAUTIONS AND REQUESTS>

- The **⚠ WARNING** and **⚠ CAUTION** symbols in this manual are safety precautions for the installing and handling of the product, so be sure to always follow the instructions.
- **⚠ WARNING** : Failure to follow instructions may result in threat to life or serious injury.
- **⚠ CAUTION** : Failure to follow instructions may result in accidents, injury or damage to the vehicle.
- Do not conduct any installation or usage that is not on this manual.
- Do not install altered product in your vehicle.
- In order to insure safety and reliability, conduct all installation, removal and disposal at Mazda dealers.
- If you have any questions concerning the installing or handling of this product, please contact the dealer where you purchased this product.
- Mazda Motor Corporation and Mazda dealers (distributors) assume no responsibility for any problems that may occur from not following the instructions stated in this manual.
- Be careful not to misplace, scratch, or contaminate the removed parts with foreign substances such as fat.

### Authorized Dealers

- Be sure to return this manual to the customer after installation.

### To Customers

- Retain this installation (instruction) manual for future reference.
- When handing over this product to another customer, be sure to hand over this manual along with the product.

**Mazda Motor Corporation**

3-1, Shinchii, Fuchu-cho, Aki-gun Hiroshima



「198809-3040」は  
変更です。  
198809-3020  
(54500005E)

# 1. COMPONENT PARTS

## ▼ KIT LIST

**⚠ CAUTION**

- Check the chart shown below and make sure that no parts are missing. Make sure that all component parts are free from dirt, scratches, or damages.

Part	Part Name	Qty.	Part	Part Name	Qty.
 EX5493	① Aluminum Accel Pedal	1	 EX5526	② Installation (Instruction) Manual	1

## ▼ FINISHED IMAGE

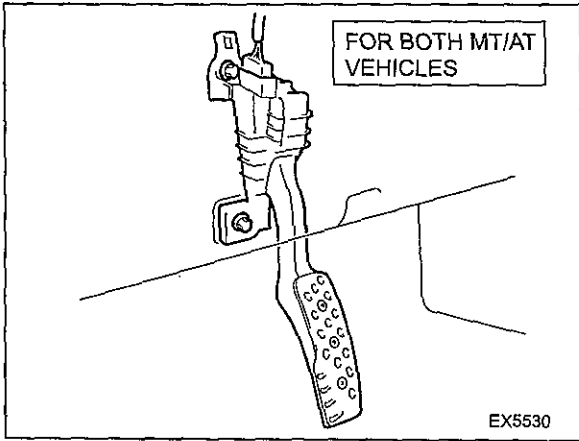

## 2. Before Installation

### REQUIRED TOOLS

- ☆ Socket Wrench
- ☆ Torque Wrench (that can measure 7.8 to 10.8 N•m)

### ⚠ WARNING

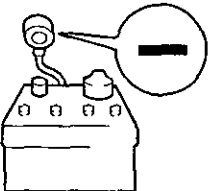
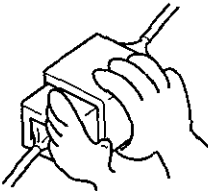
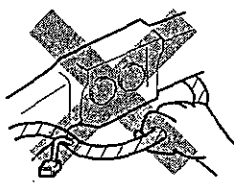
<p>When the negative battery cable is connected during operation, it may cause electric shock or other personal injuries. Disconnect the negative battery cable before removal/installation.</p>	<p>When connecting/disconnecting connectors, grasp the connectors, not the wires. Otherwise a short, an accident from poor contact or fire may occur.</p>	<p>Do not pull the harness with excessive force. Doing so can cause a breakage or a short-related accident, as well as an electrical short or fire.</p>
 <p>EX5496</p>	 <p>EX5497</p>	 <p>EX5498</p>

### ⚠ CAUTION

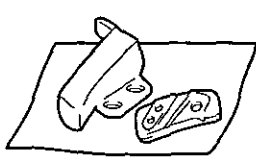
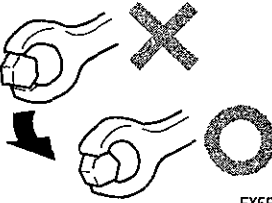
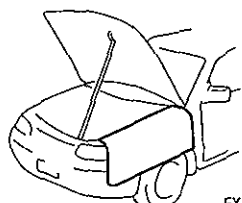
<p>Put the removed parts and new parts in the kit on a protective sheet to prevent scratches.</p>	<p>Using improper tools may cause damage and or broken parts. Use the correct tool for the job.</p>	<p>Be sure to cover the vehicle body with protectors or mats to prevent stains, scratches and damage when removing/installing the vehicle parts.</p>
 <p>EX5499</p>	 <p>EX5500</p>	 <p>EX5501</p>

### ⚠ WARNING

- Work in a flat place with the wheel block on the vehicle.

### ⚠ CAUTION

- When the negative battery cable is removed, the clock, radio, trip meters and other memories will be erased. Before performing work, record the content of memory.

### REFERENCE

- Refer to maintenance handbook for removal/assembly of parts on vehicle.

### 3 REMOVING THE BATTERY TERMINAL

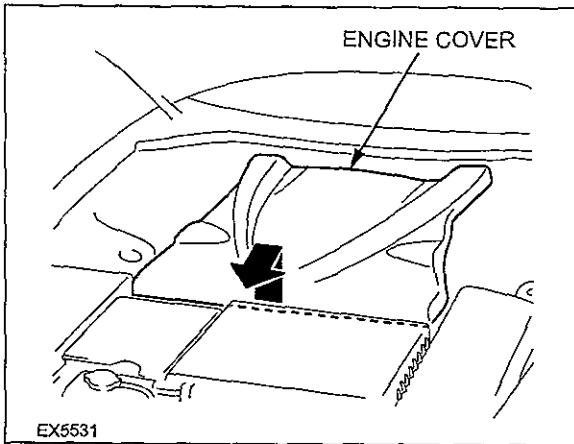

#### ■ RX-8 vehicle only

#### REMOVING THE BATTERY TERMINAL

1. Confirm that the power for the headlamp and air conditioner is switched off.
2. Remove the engine cover.

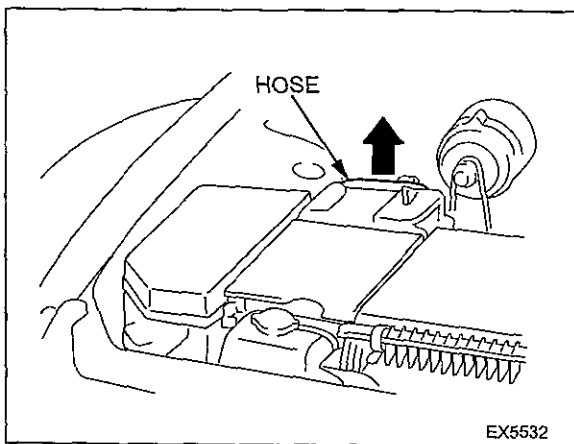

3. Remove the hose from the battery cover.

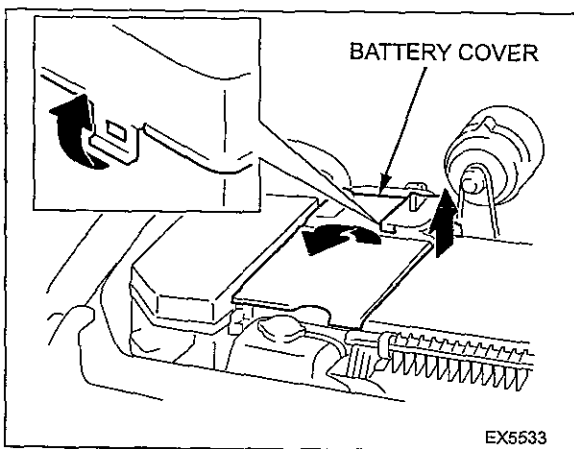

4. Lift the rear side of the battery cover and remove it.

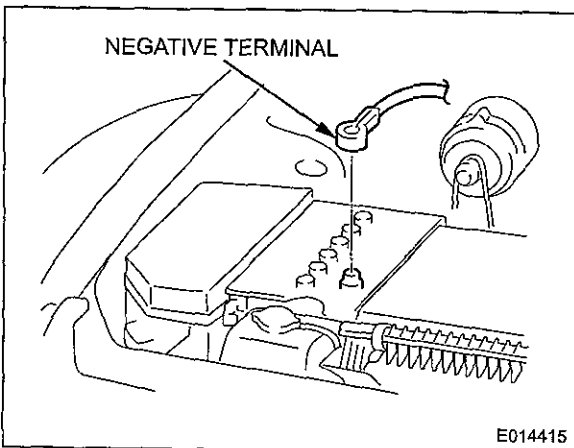

5. Remove the negative terminal.

#### ⚠ CAUTION

- When handling the battery, be sure not to place it near fires. Failure to do so may cause explosion due to the ignition of superheating gases emitted from the battery.

■ MX-5 vehicle only

**REMOVING THE BATTERY TERMINAL**

1. Confirm that the power for the head-lamp and air conditioner is switched off.

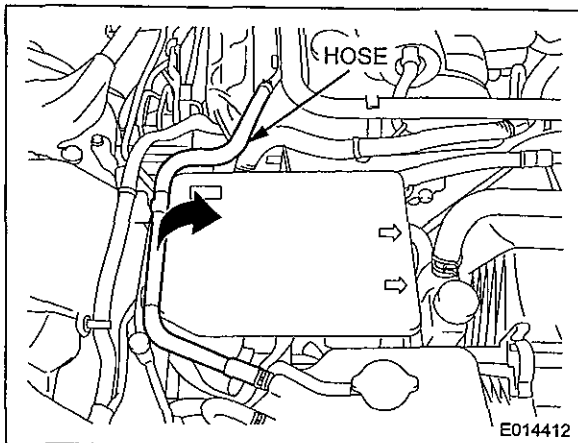

2. Remove the hose from the battery cover.

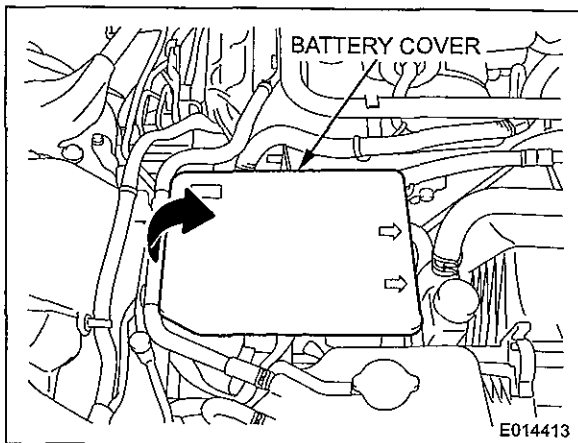

3. Lift the rear side of the battery cover and remove it.

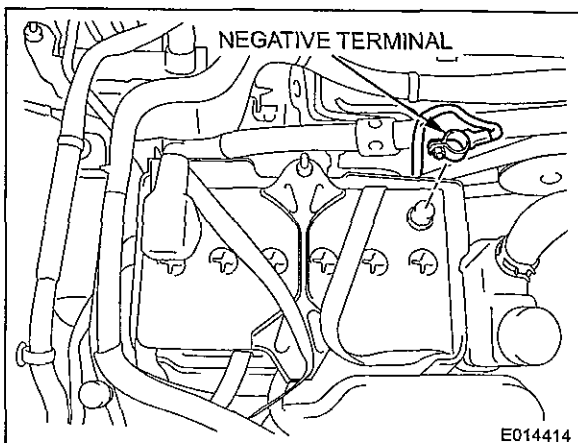

4. Remove the negative terminal.

**⚠ CAUTION**

- When handling the battery, be sure not to place it near fires. Failure to do so may cause explosion due to the ignition of superheating gases emitted from the battery.

## 4. INSTALLING THE ALUMINUM ACCEL

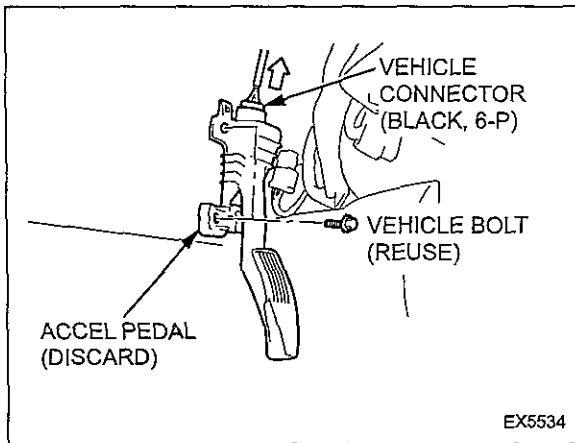

### REMOVING THE ACCEL PEDAL

1. Remove the vehicle connector of the accel pedal.
2. Remove the bolts (two locations, reusable) and remove the accel pedal (discarded).

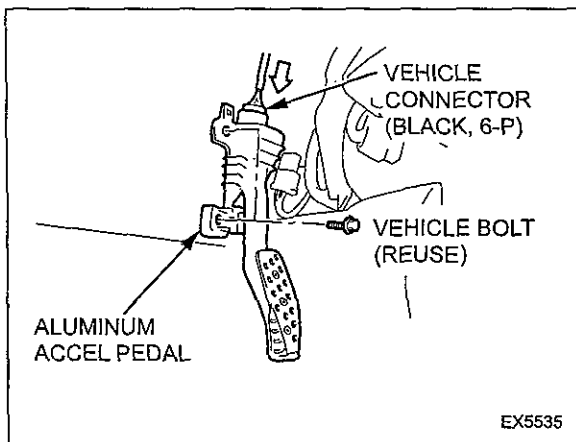

### INSTALLING THE ALUMINUM ACCEL PEDAL

1. Take the same steps as the removal of the accel pedal in the opposite order to install the aluminum accel pedal.
2. Connect the vehicle connector to the aluminum accel pedal.

Tightening Torque bolt : 7.8 to 10.8N·m

#### ⚠ CAUTION

- After installing, step on the aluminum accel pedal to make sure that there is no interference with the surrounding vehicle parts.

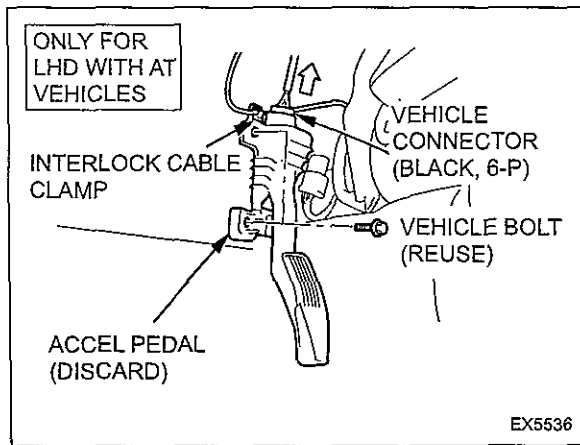

- The following steps are for vehicles that are LHD with AT. Follow these steps to install the aluminum accel pedal.

#### REMOVING THE ACCEL PEDAL

1. Remove the vehicle connectors of the accel pedal.
2. Loosen the bolts (two locations) and suspend the accel pedal.
3. Remove the interlock cable clamp from the accel pedal.
4. Remove the bolts (two locations, reusable) completely and remove the accel pedal (disused).

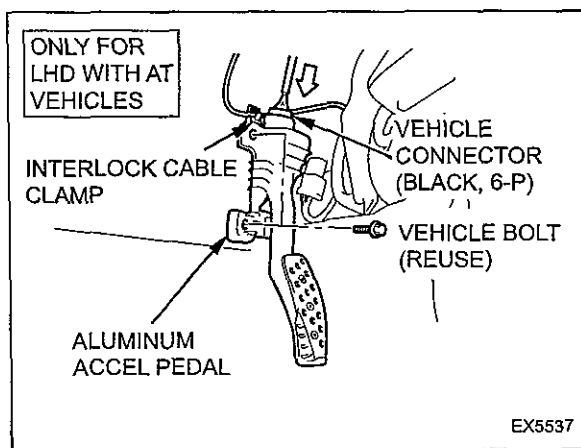

#### INSTALLING THE ALUMINUM ACCEL PEDAL

1. Take the same steps as the removal of the accel pedal in the opposite order to install the aluminum accel pedal.
2. Install the interlock cable clamp to the aluminum accel pedal.
3. Connect the vehicle connector to the aluminum accel pedal.

Tightening Torque bolt : 7.8 to 10.8N•m

#### ⚠ CAUTION

- After installing, step on the aluminum accel pedal to make sure that there is no interference with the surrounding vehicle parts.

## 5 RESTORING THE BATTERY TERMINAL

### RESTORING THE BATTERY TERMINAL

- Take the same steps as the removal of the battery terminal in the opposite order to restore the battery terminal.

## 6 CONFIRMATION STEPS AFTER INSTALLING IS COMPLETED

### ⚠ CAUTION

- When connection to the battery is cut off, the DSC indication lamp will not operate. (In this case the DSC OFF lamp will flash and the TCS/DSC operation indicator will light up.)

- (1) Turn the ignition switch to the ON position.
- (2) Turn the steering wheel all the way to the right and then all the way to the left.
- (3) Confirm that the DSC OFF indication lamp is turned off.
- (4) Turn the ignition switch to the OFF position and then back to the ON position.
- (5) Confirm that the TCS/DSC operation indicator lamp is turned off. If the TCS/DSC operation indicator lamp and the DSC OFF indicator lamp does not go off after the ignition switch is turned to the ON position, contact your Mazda dealer.

1. Attach the battery cover by reversing the procedure used to take it off.

### ⚠ CAUTION

- When attaching the engine cover, make sure that it is securely in place.

2. Check the operation.

### ⚠ CAUTION

- If the wiring to the battery is interrupted, the auto up/down feature of the power windows will not correctly operate.

Reset it with the following steps.

1. Turn the engine switch to ON.
2. Press the switch to fully close the window.
3. Push up the switch to fully close the window, and then keep on pushing up for 2 seconds.

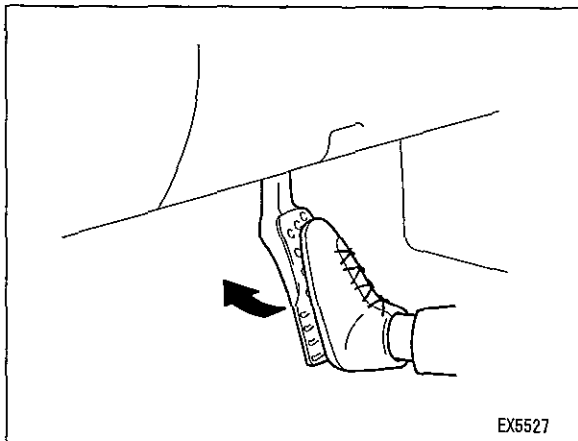

### ⚠ CAUTION

- Step on the accel pedal lightly when the engine is turned on and confirm the blow and the tachometer. If there is a malfunction in the blow or tachometer, contact your Mazda dealer.



- TO CUSTOMERS -

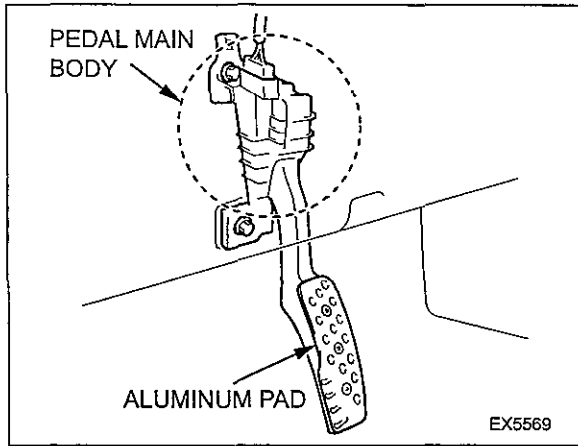

**⚠ CAUTION**

- Make sure that there are no loose or wobbly plate screws or bolts, and inspect periodically.
- For the maintenance, take care of the following;
  - (1) Do not use a scrubbing brush at the time of washing because the surface may be scratched.
  - (2) If it is hard to remove dirt or stains, wash it using a watered-down neutral detergent, then in water.
  - (3) Pay attention that the main body does not get wet.

【MEMO】

**INSTALLATION  
INSPECTION SHEET**

<b>RX-8 MX-5</b>	<b>Aluminum Accel Pedal (for AT/MT vehicles)</b>
<b>F151 V8 221</b>	

**Inspection Items After Installation**

- Inspect the installed parts according to the following chart.

Inspection Item	Items to be inspected ( O )			
	Clearance/Fit	Scratches, Dirt, Harness interference	Installation, Tight- ening/Engage- ment	Operation
Aluminum Accel Pedal	○	○	○	○

CUT LINE

**Aluminum Accel Pedal**

Date					
Vehicle Body Number					
Approved		Checked		Person In charge	

**\*Storage period for Installation Inspection Sheet: 3 months**

