

INSTALLATION INSTRUCTIONS

ELECTRICAL GAUGES

SMOKE LENS SERIES WHITE & AMBER LED DISPLAY

OPENING CEREMONY

Temp Gauge

DPWA603426B

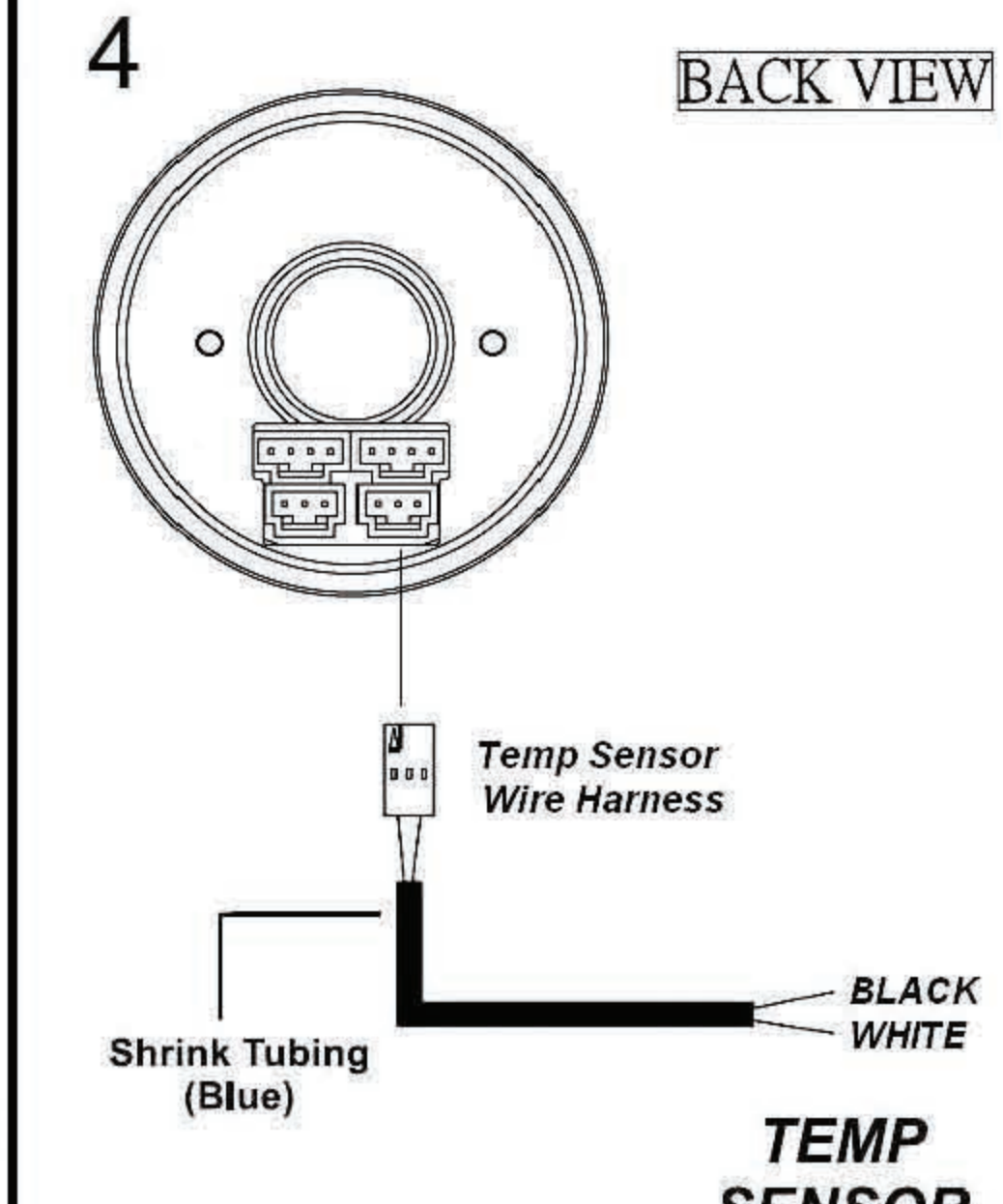
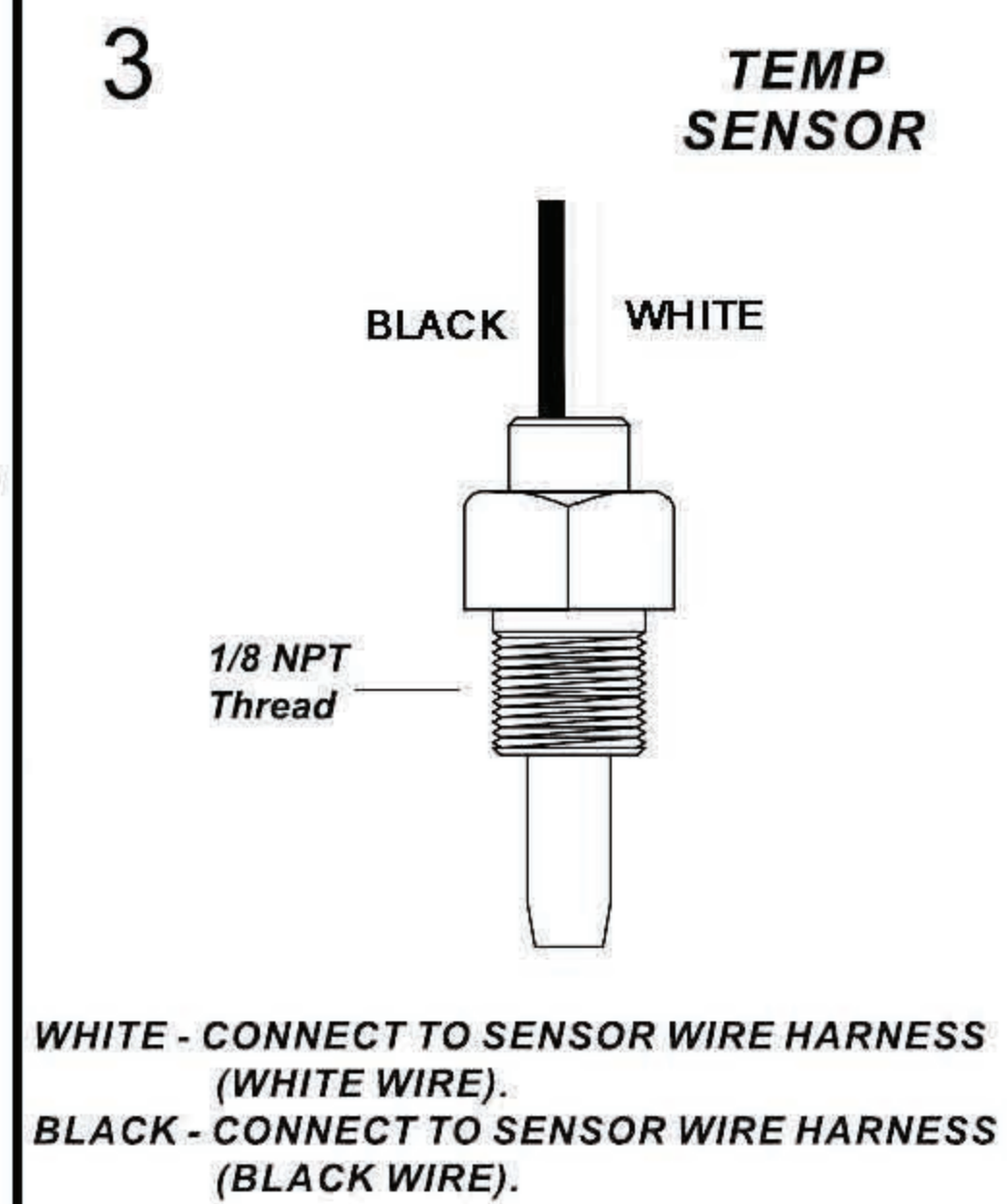
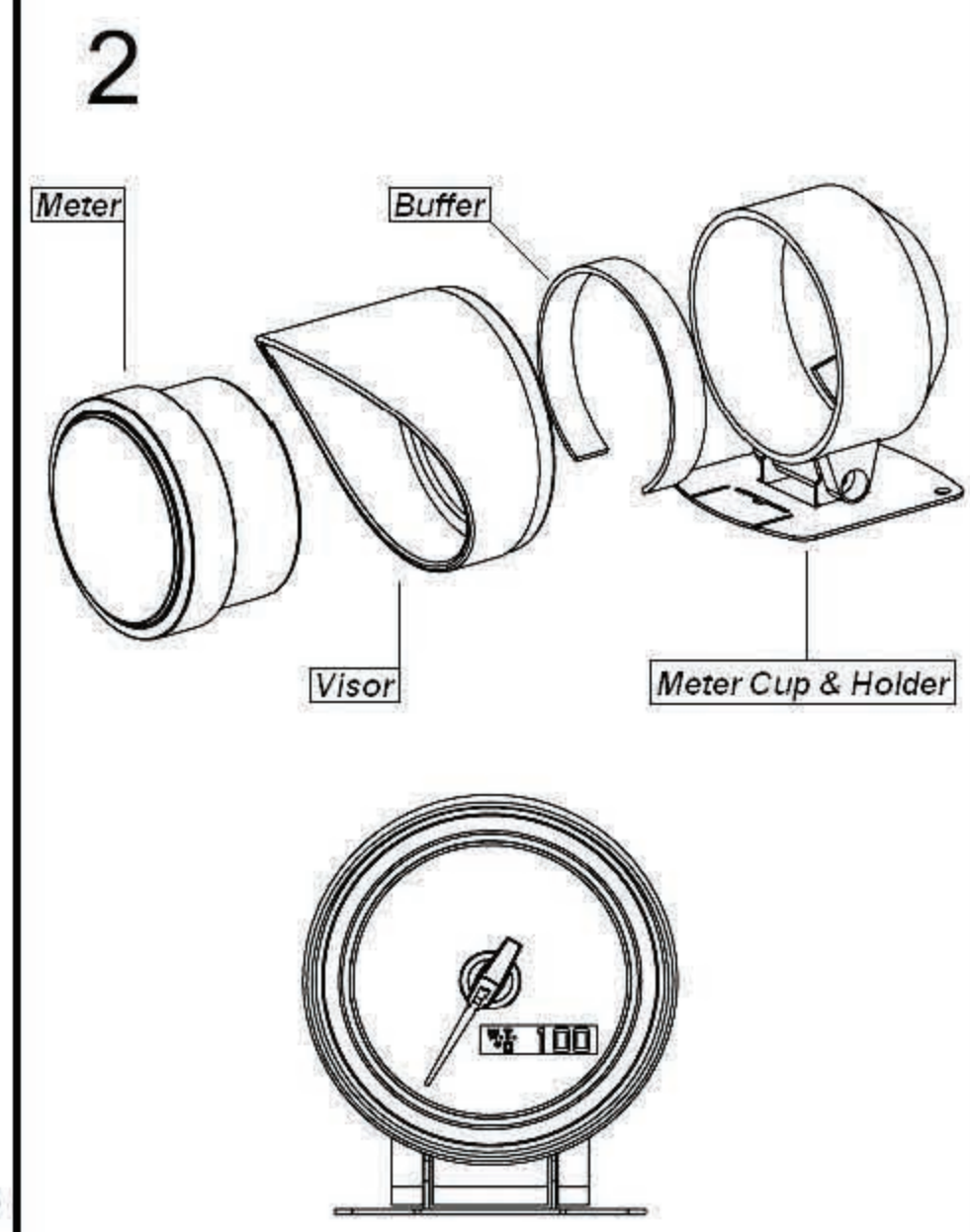
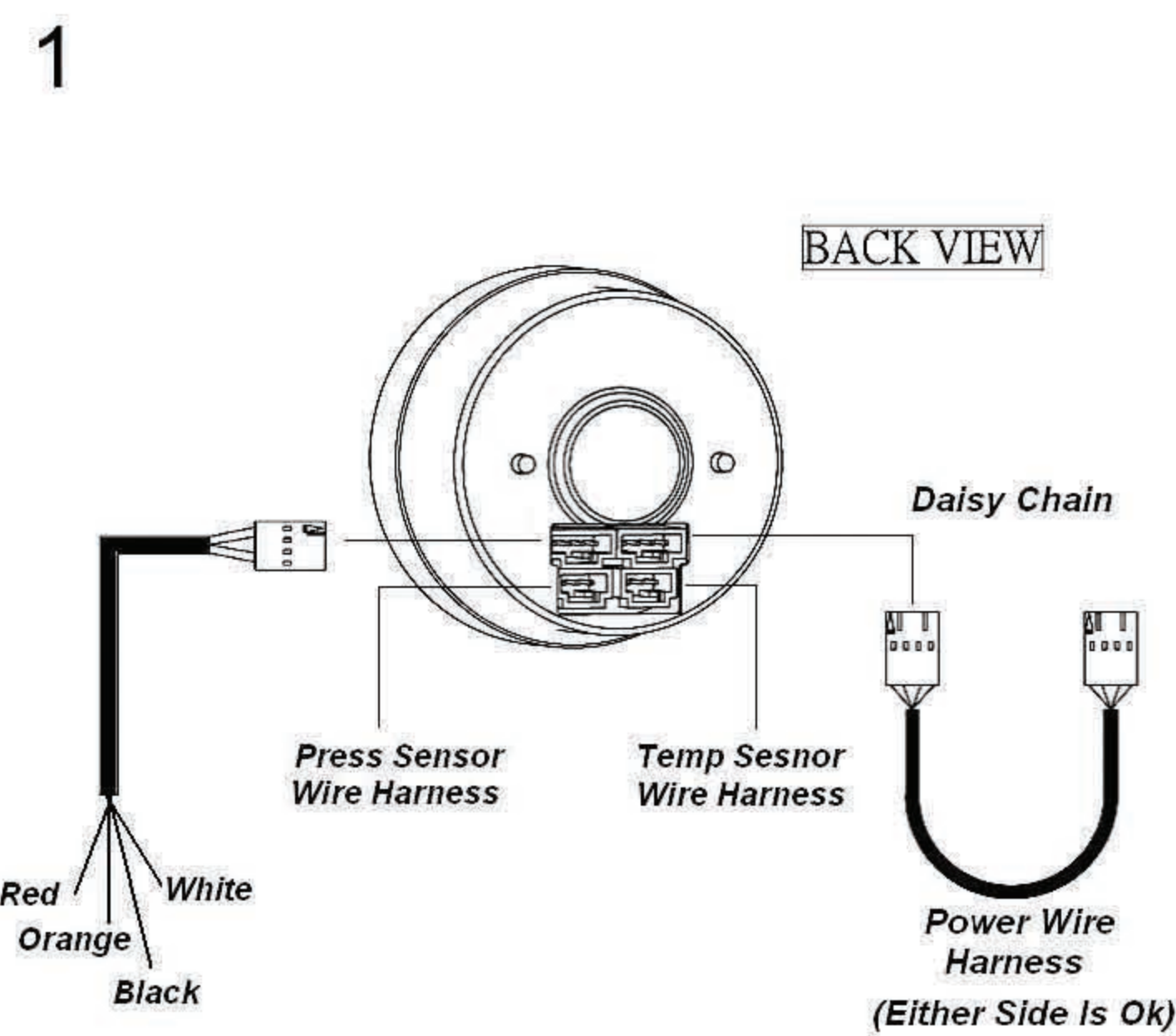

Press Gauge For Oil Press

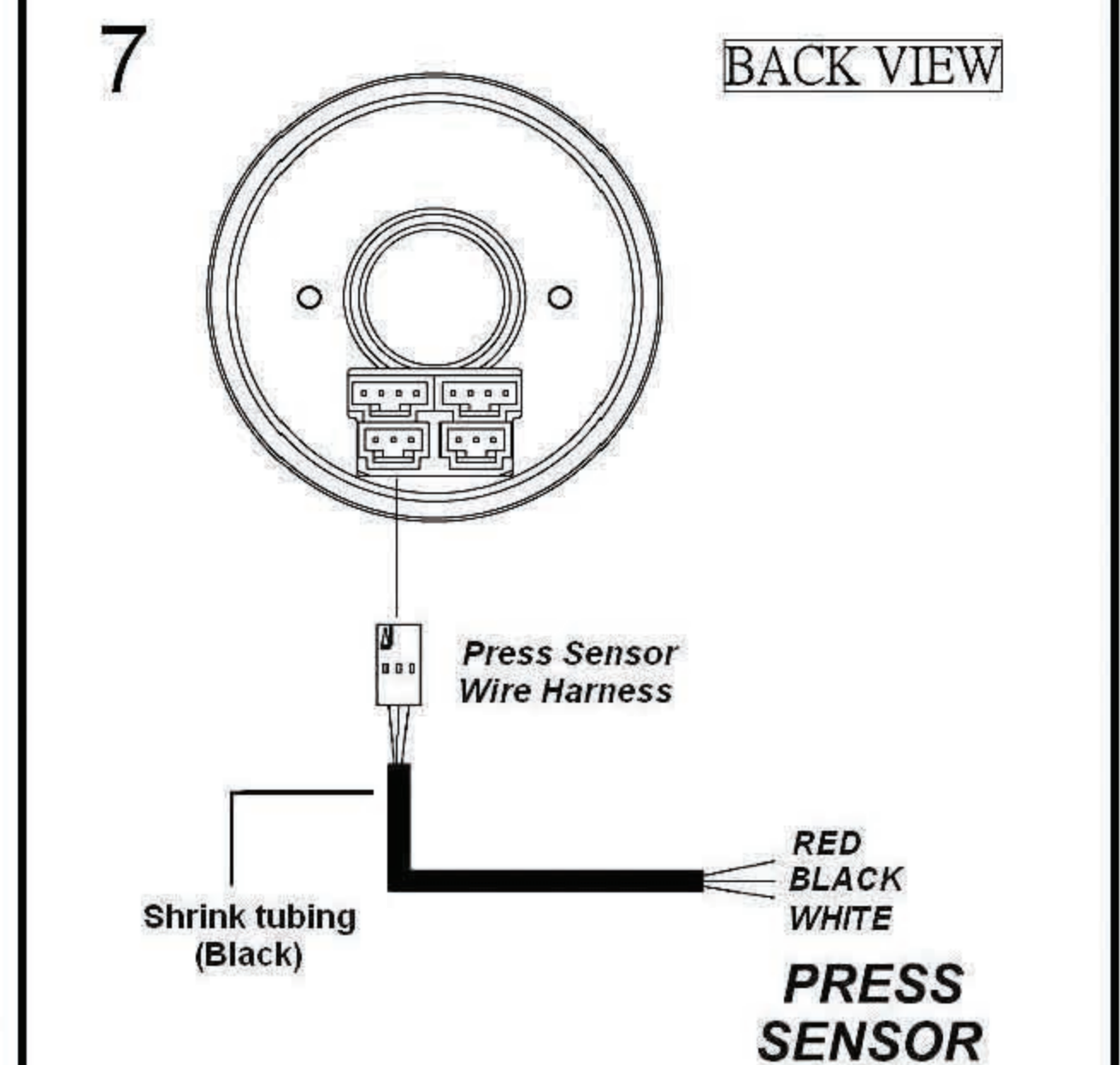
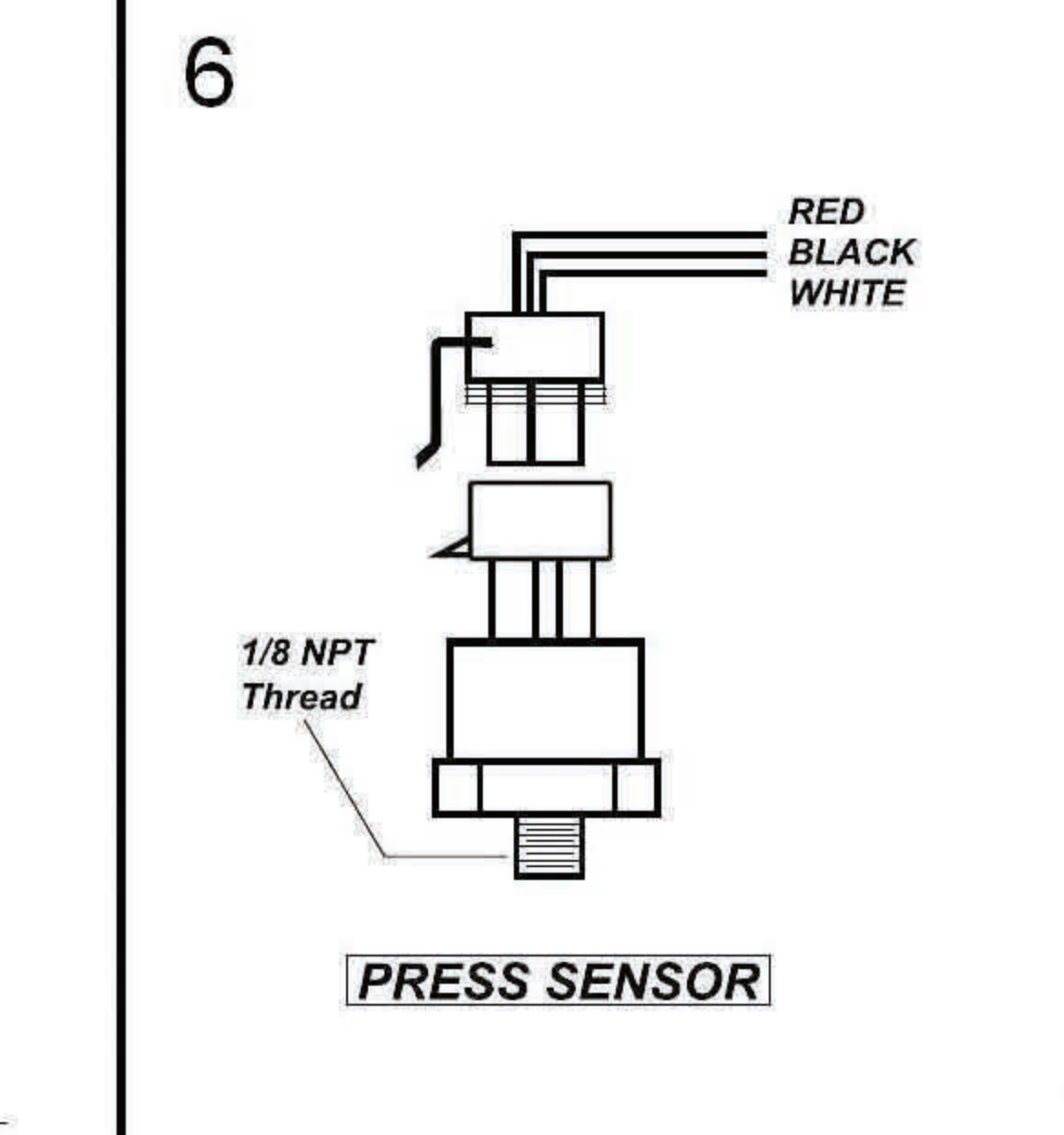
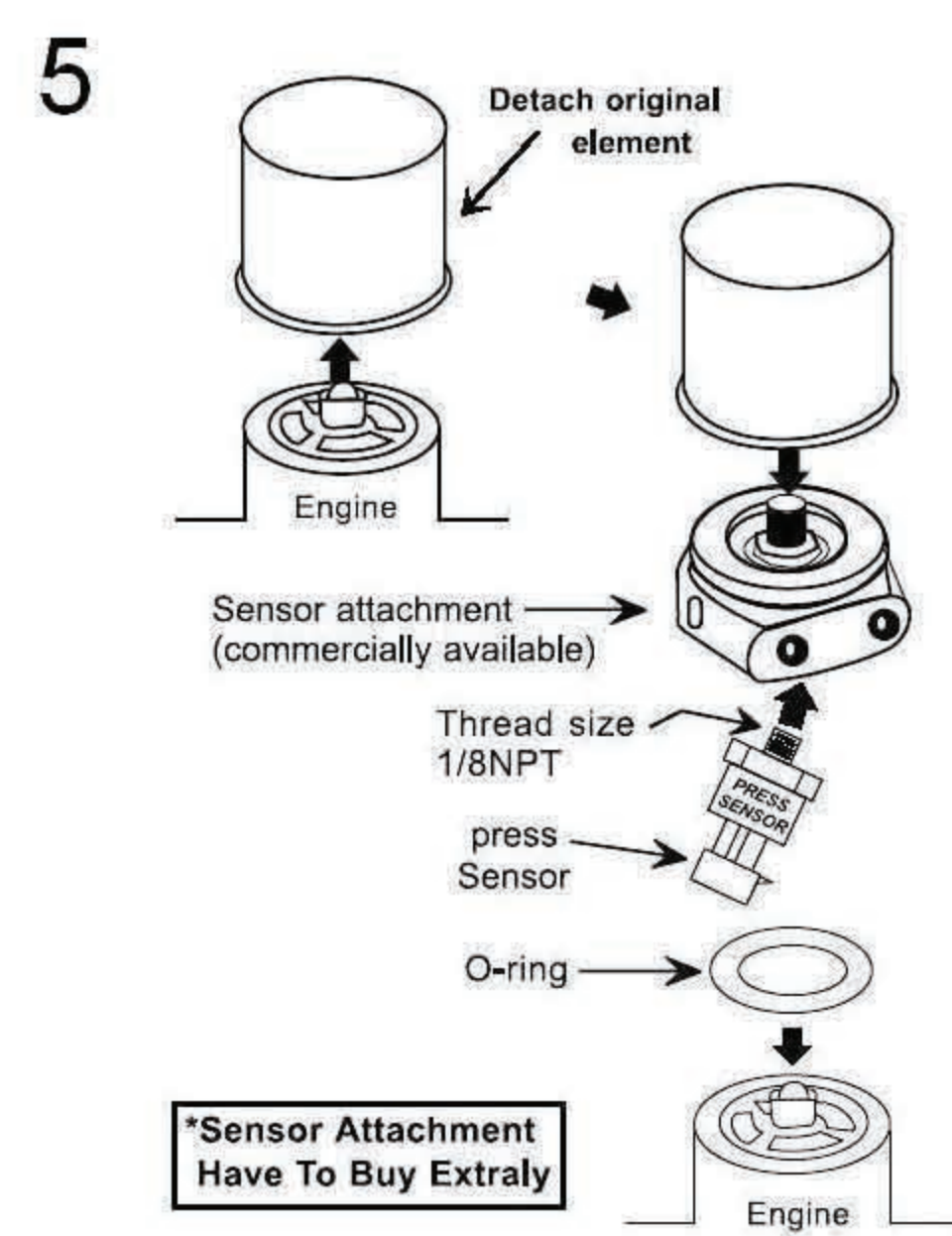

Press Gauge For Fuel Press

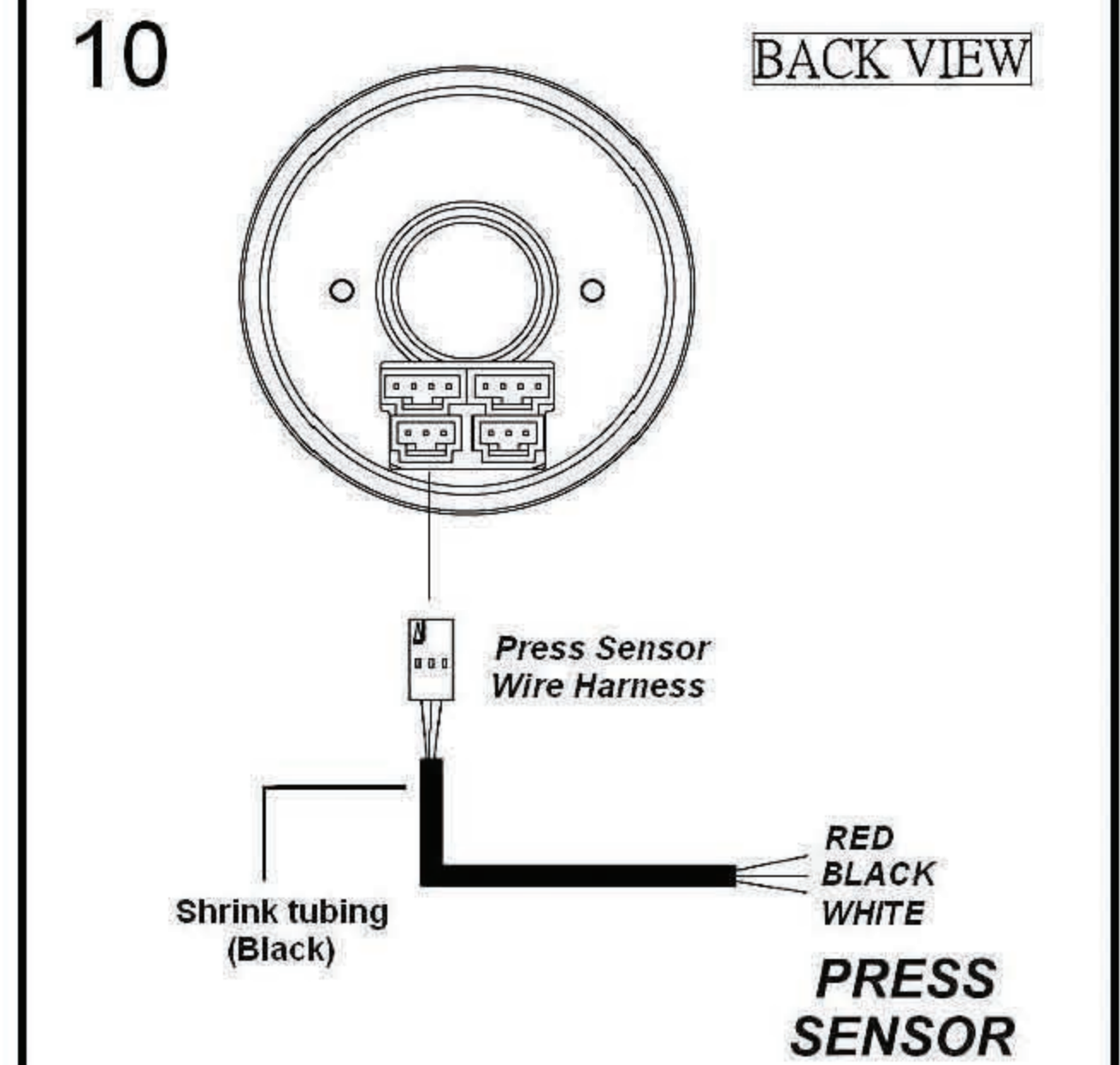
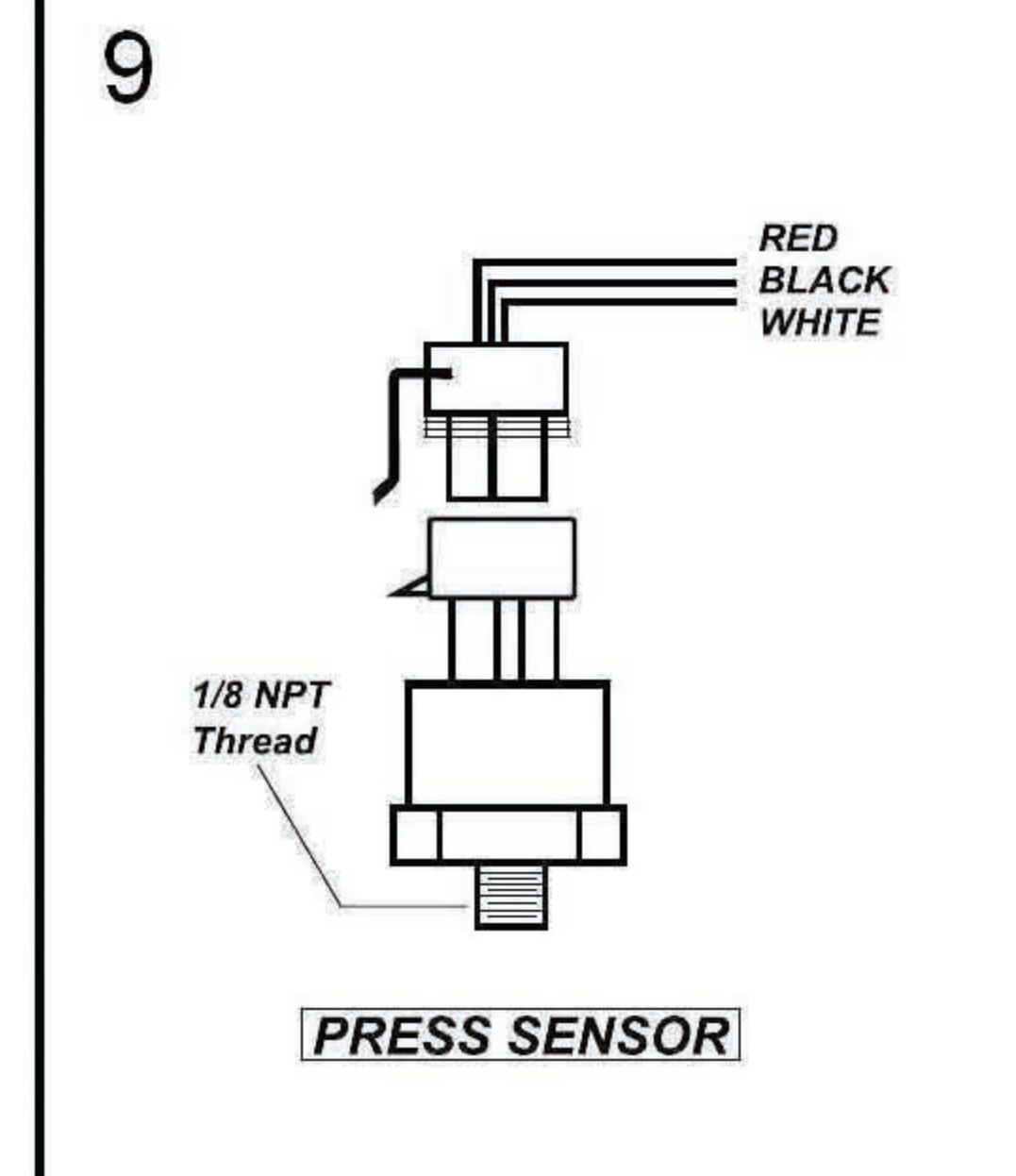
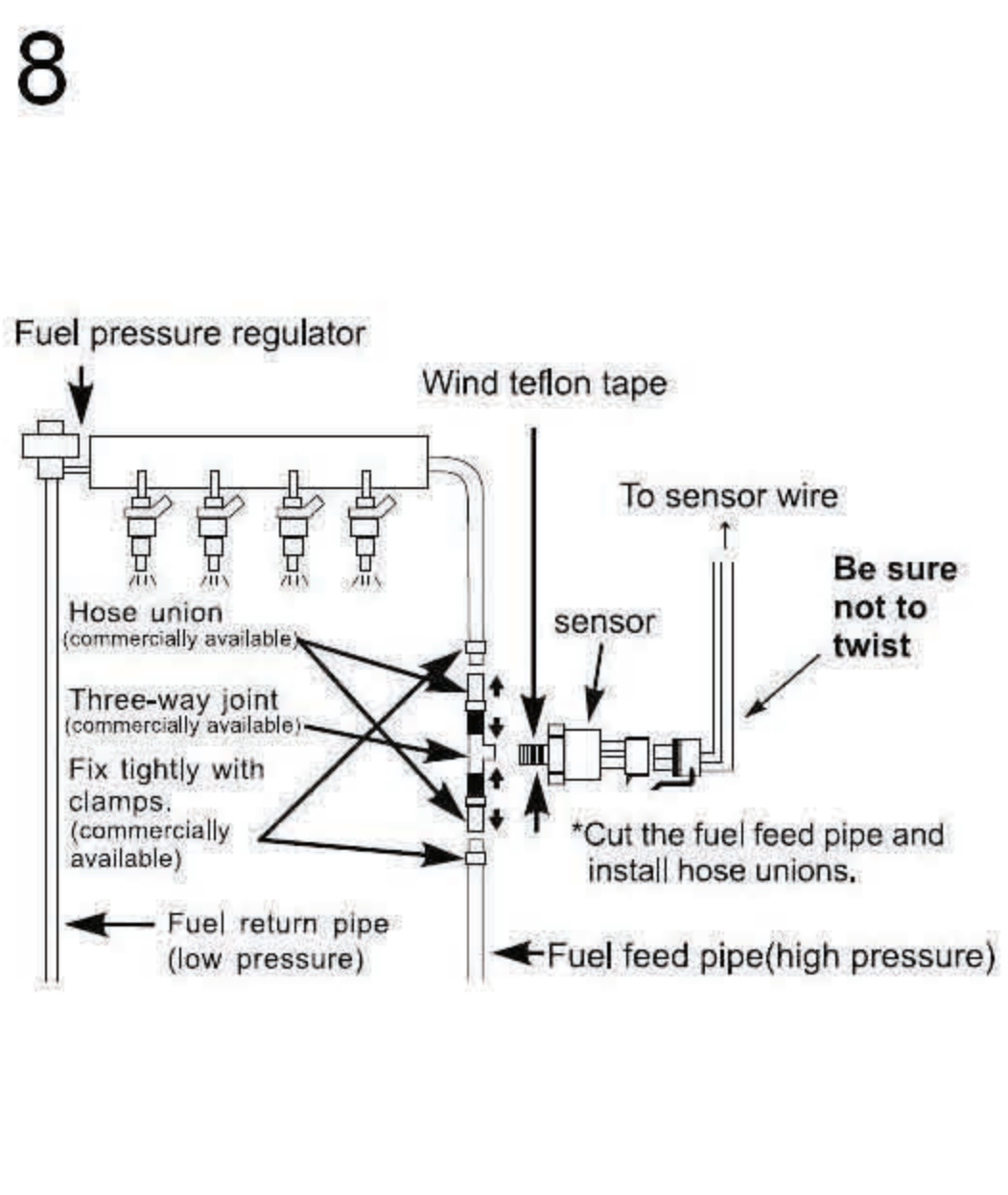

1. Connect power wire (RED) to +12V battery wire.
2. Connect power wire (BLACK) to ground, negative (-) battery terminal or a good chassis ground.
3. ORANGE - Note
4. WHITE - Note

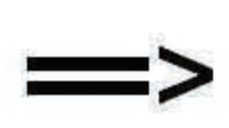

NOTE: GAUGE REQUIRE FUNCTION

REQUIRE FUNCTION		INSTALLATION
DAYTIME	NIGHT TIME	
WHITE SCALE	WHITE SCALE	WHITE WIRE → CONNECT TO ACC ORANGE WIRE → NO CONNECT
AMBER RED SCALE	AMBER RED SCALE	WHITE WIRE → NO CONNECT ORANGE WIRE → CONNECT TO ACC
WHITE SCALE	AMBER RED SCALE	WHITE WIRE → CONNECT TO ACC ORANGE WIRE → CONNECT TO PARKING LAMP
AMBER RED SCALE	WHITE SCALE	ORANGE WIRE → CONNECT TO ACC WHITE WIRE → CONNECT TO PARKING LAMP