



owner.ford.com



ford.ca

December 2016
Second Printing
Owner's Manual
Mustang
Litho in U.S.A.



HR3J19A321 AB



The information contained in this publication was correct at the time of going to print. In the interest of continuous development, we reserve the right to change specifications, design or equipment at any time without notice or obligation. No part of this publication may be reproduced, transmitted, stored in a retrieval system or translated into any language in any form by any means without our written permission. Errors and omissions excepted.

© Ford Motor Company 2016

All rights reserved.

Part Number: 201603 2016111125805

Table of Contents

Introduction

About This Manual.....	7
Symbols Glossary.....	7
Data Recording.....	9
California Proposition 65.....	11
Perchlorate.....	11
Ford Credit.....	11
Replacement Parts Recommendation.....	12
Special Notices.....	12
Mobile Communications Equipment.....	14
Export Unique Options.....	14

Environment

Protecting the Environment.....	15
---------------------------------	----

At a Glance

Instrument Panel Overview.....	16
--------------------------------	----

Child Safety

General Information.....	18
Installing Child Restraints.....	19
Booster Seats.....	25
Child Restraint Positioning.....	27

Seatbelts

Principle of Operation.....	29
Fastening the Seatbelts.....	30
Seatbelt Warning Lamp and Indicator Chime.....	32
Seatbelt Reminder.....	33
Child Restraint and Seatbelt Maintenance.....	35
Seatbelt Extension.....	35

Personal Safety System™

Personal Safety System™.....	36
------------------------------	----

Supplementary Restraints System

Principle of Operation.....	37
Driver and Passenger Airbags.....	38
Front Passenger Sensing System.....	39
Side Airbags.....	41
Driver and Passenger Knee Airbags.....	43
Safety Canopy™ - Coupe.....	43
Crash Sensors and Airbag Indicator.....	44
Airbag Disposal.....	45

Keys and Remote Controls

General Information on Radio Frequencies.....	46
Remote Control.....	47
Replacing a Lost Key or Remote Control.....	50

MyKey™

Principle of Operation.....	51
Creating a MyKey.....	52
Clearing All MyKeys.....	53
Checking MyKey System Status.....	54
Using MyKey With Remote Start Systems.....	55
MyKey Troubleshooting.....	55

Doors and Locks

Locking and Unlocking.....	56
Interior Luggage Compartment Release.....	61

Security

Passive Anti-Theft System.....	62
Anti-Theft Alarm.....	63

Steering Wheel

Adjusting the Steering Wheel.....	64
Audio Control.....	64
Voice Control.....	65

Table of Contents

Cruise Control.....	65
Information Display Control.....	65

Wipers and Washers

Windshield Wipers.....	66
Autowipers.....	66
Windshield Washers.....	67

Lighting

General Information.....	68
Lighting Control.....	68
Autolamps.....	69
Instrument Lighting Dimmer.....	69
Headlamp Exit Delay.....	70
Daytime Running Lamps.....	70
Front Fog Lamps.....	71
Direction Indicators.....	71
Welcome Lighting.....	71
Interior Lamps.....	72
Ambient Lighting.....	72

Windows and Mirrors

Power Windows.....	73
Global Opening.....	73
Exterior Mirrors.....	74
Interior Mirror.....	75
Sun Visors.....	76

Instrument Cluster

Gauges.....	77
Warning Lamps and Indicators.....	79
Audible Warnings and Indicators.....	82

Information Displays

General Information.....	83
Information Messages.....	91

Climate Control

Manual Climate Control.....	102
-----------------------------	-----

Automatic Climate Control.....	103
Hints on Controlling the Interior Climate.....	105
Heated Windows and Mirrors.....	107
Cabin Air Filter.....	107
Remote Start.....	108

Seats

Sitting in the Correct Position.....	109
Head Restraints.....	109
Manual Seats.....	111
Power Seats.....	111
Memory Function.....	112
Rear Seats.....	113
Climate Controlled Seats.....	114

Universal Garage Door Opener

Universal Garage Door Opener.....	116
-----------------------------------	-----

Auxiliary Power Points

Auxiliary Power Points.....	120
-----------------------------	-----

Storage Compartments

Center Console.....	121
Glasses Holder.....	121

Starting and Stopping the Engine

General Information.....	122
Keyless Starting.....	122
Steering Wheel Lock.....	123
Starting a Gasoline Engine.....	123
Engine Block Heater.....	125

Fuel and Refueling

Safety Precautions.....	127
Fuel Quality.....	128
Fuel Filler Funnel Location.....	128
Running Out of Fuel.....	128

Table of Contents

Refueling.....	130	Collision Warning System.....	168
Fuel Consumption.....	132	Drive Control.....	170
Emission Control System.....	133		
Transmission		Load Carrying	
Manual Transmission.....	136	Load Limit.....	172
Automatic Transmission.....	138		
Rear Axle		Towing	
Limited Slip Differential.....	141	Towing a Trailer.....	177
		Recommended Towing Weights.....	178
Brakes		Essential Towing Checks.....	179
General Information.....	142	Towing the Vehicle on Four Wheels.....	180
Hints on Driving With Anti-Lock Brakes.....	142		
Parking Brake.....	143	Convertible Top	
Hill Start Assist.....	143	Opening the Convertible Top.....	182
		Closing the Convertible Top.....	183
Traction Control			
Principle of Operation.....	145	Driving Hints	
Using Traction Control.....	145	Breaking-In.....	185
		Economical Driving.....	185
Stability Control		Driving Through Water.....	185
Principle of Operation.....	146	Floor Mats.....	186
Using Stability Control.....	147		
Parking Aids		Roadside Emergencies	
Principle of Operation.....	150	Roadside Assistance.....	188
Rear Parking Aid.....	150	Hazard Flashers.....	189
Rear View Camera.....	151	Fuel Shutoff.....	189
		Jump Starting the Vehicle.....	190
Cruise Control		Post-Crash Alert System.....	192
Principle of Operation.....	155	Transporting the Vehicle.....	192
Using Cruise Control.....	155		
Using Adaptive Cruise Control.....	156	Customer Assistance	
Driving Aids		Getting the Services You Need.....	194
Blind Spot Information System.....	162	In California (U.S. Only).....	195
Cross Traffic Alert.....	164	The Better Business Bureau (BBB) Auto Line Program (U.S. Only).....	196
Steering.....	167	Utilizing the Mediation/Arbitration Program (Canada Only).....	197
		Getting Assistance Outside the U.S. and Canada.....	197

Table of Contents

Ordering Additional Owner's Literature.....	198
Reporting Safety Defects (U.S. Only).....	199
Reporting Safety Defects (Canada Only).....	199

Fuses

Fuse Specification Chart.....	201
Changing a Fuse.....	208

Maintenance

General Information.....	210
Opening and Closing the Hood.....	210
Under Hood Overview - 2.3L EcoBoost™.....	212
Under Hood Overview - 3.7L.....	213
Under Hood Overview - 5.0L.....	214
Engine Oil Dipstick.....	215
Engine Oil Check.....	215
Engine Coolant Check.....	216
Manual Transmission Fluid Check.....	220
Automatic Transmission Fluid Check.....	220
Brake Fluid Check.....	221
Clutch Fluid Check.....	221
Power Steering Fluid Check.....	221
Washer Fluid Check.....	222
Fuel Filter.....	222
Changing the 12V Battery.....	222
Checking the Wiper Blades.....	224
Changing the Wiper Blades.....	224
Adjusting the Headlamps.....	224
Changing a Bulb.....	226
Bulb Specification Chart.....	228
Changing the Engine Air Filter.....	229

Vehicle Care

General Information.....	230
Cleaning Products.....	230

Cleaning the Exterior.....	231
Waxing.....	232
Cleaning the Engine.....	232
Cleaning the Windows and Wiper Blades.....	233
Cleaning the Interior.....	233
Cleaning the Instrument Panel and Instrument Cluster Lens.....	234
Cleaning Leather Seats.....	234
Repairing Minor Paint Damage.....	235
Cleaning the Wheels.....	235
Vehicle Storage.....	235
Cleaning the Convertible Top.....	237

Wheels and Tires

Tire Sealant and Inflator Kit.....	238
Tire Care.....	244
Using Summer Tires.....	259
Using Snow Chains.....	259
Tire Pressure Monitoring System.....	260
Changing a Road Wheel.....	264
Driving at High Speed.....	269
Technical Specifications.....	270

Capacities and Specifications

Engine Specifications - 2.3L EcoBoost™.....	271
Engine Specifications - 3.7L.....	271
Engine Specifications - 5.0L.....	272
Motorcraft Parts - 2.3L EcoBoost™.....	273
Motorcraft Parts - 3.7L.....	274
Motorcraft Parts - 5.0L.....	275
Vehicle Identification Number.....	276
Vehicle Certification Label.....	277
Transmission Code Designation.....	277
Capacities and Specifications - 2.3L EcoBoost™.....	278
Capacities and Specifications - 3.7L.....	283
Capacities and Specifications - 5.0L.....	288

Table of Contents

Audio System

General Information.....	293
Audio Unit - Vehicles With: AM/FM/CD/ SYNC.....	294
Audio Unit - Vehicles With: AM/FM/CD/ SYNC/Touchscreen Display.....	299
Digital Radio.....	300
Satellite Radio.....	302
USB Port.....	305

SYNC™

General Information.....	306
Using Voice Recognition.....	308
Using SYNC™ With Your Phone.....	310
SYNC™ Applications and Services.....	322
Using SYNC™ With Your Media Player.....	327
SYNC™ Troubleshooting.....	336

SYNC™ 3

General Information.....	344
Home Screen.....	355
Using Voice Recognition.....	356
Entertainment.....	363
Climate.....	373
Phone.....	377
Navigation.....	382
Apps.....	390
Settings.....	393
SYNC™ 3 Troubleshooting.....	405

Accessories

Accessories.....	418
------------------	-----

Ford Protect

Ford Protect.....	420
-------------------	-----

Scheduled Maintenance

General Maintenance Information.....	422
Normal Scheduled Maintenance.....	425

Special Operating Conditions Scheduled Maintenance.....	428
Scheduled Maintenance Record.....	430

Appendices

End User License Agreement.....	440
Type Approvals.....	464

Introduction

ABOUT THIS MANUAL

Thank you for choosing Ford. We recommend that you take some time to get to know your vehicle by reading this manual. The more that you know about your vehicle, the greater the safety and pleasure you will get from driving it.

WARNING



Driving while distracted can result in loss of vehicle control, crash and injury. We strongly recommend that you use extreme caution when using any device that may take your focus off the road. Your primary responsibility is the safe operation of your vehicle. We recommend against the use of any hand-held device while driving and encourage the use of voice-operated systems when possible. Make sure you are aware of all applicable local laws that may affect the use of electronic devices while driving.

Note: This manual describes product features and options available throughout the range of available models, sometimes even before they are generally available. It may describe options not fitted to the vehicle you have purchased.

Note: Some of the illustrations in this manual may show features as used in different models, so may appear different to you on your vehicle.

Note: Always use and operate your vehicle in line with all applicable laws and regulations.

Note: Pass on this manual when selling your vehicle. It is an integral part of your vehicle.

This manual may qualify the location of a component as left-hand side or right-hand side. The side is determined when facing forward in the seat.



E154903

A Right-hand side.

B Left-hand side.

SYMBOLS GLOSSARY

These are some of the symbols you may see on your vehicle.



Air conditioning system



Air conditioning system lubricant type



Anti-lock braking system



Avoid smoking, flames or sparks



Battery



Battery acid



Brake fluid - non petroleum based



Brake system

Introduction



Cabin air filter



Front airbag



Check fuel cap



Front fog lamps



Child safety door lock or unlock



Fuel pump reset



Child seat lower anchor



Fuse compartment



Child seat tether anchor



Hazard warning flashers



Cruise control



Heated rear window



Do not open when hot



Heated windshield



Engine air filter



Interior luggage compartment release



Engine coolant



Jack



Engine coolant temperature



Keep out of reach of children



Engine oil



Lighting control



Explosive gas



Low tire pressure warning



Fan warning



Maintain correct fluid level



Fasten seatbelt



Note operating instructions



Flammable



Panic alarm

Introduction



Parking aid



Parking brake



Power steering fluid



Power windows front/rear



Power window lockout



Requires registered technician



Safety alert



See Owner's Manual



See Service Manual



Service engine soon



Side airbag



Shield the eyes



Stability control



Windshield wash and wipe

DATA RECORDING

Service Data Recording

Service data recorders in your vehicle are capable of collecting and storing diagnostic information about your vehicle. This potentially includes information about the performance or status of various systems and modules in the vehicle, such as engine, throttle, steering or brake systems. In order to properly diagnose and service your vehicle, Ford Motor Company (Ford of Canada in Canada), and service and repair facilities may access or share among them vehicle diagnostic information received through a direct connection to your vehicle when diagnosing or servicing your vehicle. Additionally, Ford Motor Company (Ford of Canada, in Canada) may, where permitted by law, use vehicle diagnostic information for vehicle improvement or with other information we may have about you, (for example, your contact information), to offer you products or services that may interest you. Data may be provided to our service providers such as part suppliers that may help diagnose malfunctions, and who are similarly obligated to protect data. We retain this data only as long as necessary to perform these functions or to comply with law. We may provide information where required in response to official requests to law enforcement or other government authorities or third parties acting with lawful authority or court order, and such information may be used in legal proceedings. For U.S. only (if equipped), if you choose to use connected apps and services, such as SYNC Vehicle Health Report or MyFord Mobile App, you consent that certain diagnostic information may also be accessed electronically by Ford Motor Company and Ford authorized service facilities, and that the diagnostic information may be used to provide

Introduction

services to you, personalizing your experience, troubleshoot, and to improve products and services and offer you products and services that may interest you, where permitted by law. For Canada only, for more information, please review the Ford of Canada privacy policy at www.ford.ca, including our U.S. data storage and use of service providers in other jurisdictions who may be subject to legal requirements in Canada, the United States and other countries applicable to them, for example, lawful requirements to disclose personal information to governmental authorities in those countries. See **SYNC™** (page 306).

Event Data Recording

This vehicle is equipped with an event data recorder. The main purpose of an event data recorder is to record, in certain crash or near crash-like situations, such as an airbag deployment or hitting a road obstacle; this data will assist in understanding how a vehicle's systems performed. The event data recorder is designed to record data related to vehicle dynamics and safety systems for a short period of time, typically 30 seconds or less.

The event data recorder in this vehicle is designed to record such data as:

- **How various systems in your vehicle were operating;**
- **Whether or not the driver and passenger safety belts were buckled/fastened;**
- **How far (if at all) the driver was depressing the accelerator and/or the brake pedal; and**
- **How fast the vehicle was traveling; and**
- **Where the driver was positioning the steering wheel.**

This data can help provide a better understanding of the circumstances in which crashes and injuries occur.

Note: Event data recorder data is recorded by your vehicle only if a non-trivial crash situation occurs; no data is recorded by the event data recorder under normal driving conditions and no personal data or information (e.g., name, gender, age, and crash location) is recorded (see limitations regarding 911 Assist and Traffic, directions and Information privacy below). However, parties, such as law enforcement, could combine the event data recorder data with the type of personally identifying data routinely acquired during a crash investigation.

To read data recorded by an event data recorder, special equipment is required, and access to the vehicle or the event data recorder is needed. In addition to the vehicle manufacturer, other parties, such as law enforcement, that have such special equipment, can read the information if they have access to the vehicle or the event data recorder. Ford Motor Company and Ford of Canada do not access event data recorder information without obtaining consent, unless pursuant to court order or where required by law enforcement, other government authorities or other third parties acting with lawful authority. Other parties may seek to access the information independently of Ford Motor Company and Ford of Canada.

Introduction

Note: *Including to the extent that any law pertaining to Event Data Recorders applies to SYNC or its features, please note the following: Once 911 Assist (if equipped) is enabled (set ON), 911 Assist may, through any paired and connected cell phone, disclose to emergency services that the vehicle has been in a crash involving the deployment of an airbag or, in certain vehicles, the activation of the fuel pump shut-off. Certain versions or updates to 911 Assist may also be capable of being used to electronically or verbally provide to 911 operators the vehicle location (such as latitude and longitude), and/or other details about the vehicle or crash or personal information about the occupants to assist 911 operators to provide the most appropriate emergency services. If you do not want to disclose this information, do not activate the 911 Assist feature. See SYNC™ (page 306).*

Additionally, when you connect to Traffic, Directions and Information (if equipped, U.S. only), the service uses GPS technology and advanced vehicle sensors to collect the vehicle's current location, travel direction, and speed ("vehicle travel information"), only to help provide you with the directions, traffic reports, or business searches that you request. If you do not want Ford or its vendors to receive this information, do not activate the service. For more information, see Traffic, Directions and Information, Terms and Conditions. See SYNC™ (page 306).

CALIFORNIA PROPOSITION 65

WARNINGS



Some constituents of engine exhaust, certain vehicle components, certain fluids contained in vehicles and certain products of component wear contain or emit chemicals known to the State of California to cause cancer and birth defects or other reproductive harm.



Battery posts, terminals and related accessories contain lead and lead compounds, chemicals known to the State of California to cause cancer and reproductive harm. Batteries also contain other chemicals known to the State of California to cause cancer. Wash your hands after handling.

PERCHLORATE

Certain components in your vehicle such as airbag modules, seatbelt pretensioners and remote control batteries may contain perchlorate material. Special handling may apply for service or vehicle end of life disposal.

For more information visit:

Web Address
www.dtsc.ca.gov/hazardouswaste/perchlorate

FORD CREDIT

US Only

Ford Credit offers a full range of financing and lease plans to help you acquire your vehicle. If you have financed or leased your vehicle through Ford Credit, thank you for your business.

Introduction

We offer a number of convenient ways for you to contact us, and to manage your account.

Call 1-800-727-7000.

For more information about Ford Credit and access to the Account Manager, go to www.fordcredit.com.

REPLACEMENT PARTS RECOMMENDATION

We have built your vehicle to the highest standards using quality parts. We recommend that you demand the use of genuine Ford and Motorcraft parts whenever your vehicle requires scheduled maintenance or repair. You can clearly identify genuine Ford and Motorcraft parts by looking for the Ford, FoMoCo or Motorcraft branding on the parts or their packaging.

Scheduled Maintenance and Mechanical Repairs

One of the best ways for you to make sure that your vehicle provides years of service is to have it maintained in line with our recommendations using parts that conform to the specifications detailed in this Owner's Manual. Genuine Ford and Motorcraft parts meet or exceed these specifications.

Collision Repairs

We hope that you never experience a collision, but accidents do happen. Genuine Ford replacement collision parts meet our stringent requirements for fit, finish, structural integrity, corrosion protection and dent resistance. During

vehicle development we validate that these parts deliver the intended level of protection as a whole system. A great way to know for sure you are getting this level of protection is to use genuine Ford replacement collision parts.

Warranty on Replacement Parts

Genuine Ford and Motorcraft replacement parts are the only replacement parts that benefit from a Ford Warranty. The Ford Warranty may not cover damage caused to your vehicle as a result of failed non-Ford parts. For additional information, refer to the terms and conditions of the Ford Warranty.

SPECIAL NOTICES

New Vehicle Limited Warranty

For a detailed description of what is covered and what is not covered by your vehicle's New Vehicle Limited Warranty, see the **Warranty Guide** that is provided to you along with your Owner's Manual.

Additional Warranty Information

Your vehicle carries the same warranty as other Ford models. This information is covered in its entirety in the Ford Warranty Guide. You can obtain warranty service for your vehicle at any authorized dealer nationwide.

We design and build our vehicles for our customers to drive as delivered from the factory. The Ford Warranty Guide discusses vehicle use and the installation of aftermarket parts and their effect on warranty coverage. See the Ford Warranty Guide for complete information.

Introduction

Using your vehicle on a dedicated road course may result in degraded function and failure of major systems such as the engine, transmission and rear axle due to the overheating of these systems. If you intend to use your vehicle on a dedicated road course, we suggest that you equip your vehicle with racing-type coolers to protect these three systems.

In addition, if the vehicle is subjected to dedicated road course use, we recommend the following vehicle durability maintenance:

- Change your axle lubricant and friction modifier after the initial (first) hour of high-speed operation; thereafter change the axle lubricant and friction modifier every 12 hours (under these conditions).
- Change your transmission oil after each event where your vehicle is subjected to individual on-track sessions exceeding 15 minutes.
- Change your engine oil and filter after each event.

Additionally, perform a multi-point inspection on items specified in the scheduled maintenance section of this owner guide before and after dedicated road course use. See **General Maintenance Information** (page 422). See the vehicle service manual for removal and installation procedures. Replace with Genuine Ford and Motorcraft™ service parts as needed.

These actions may not necessarily protect your powertrain from damage in dedicated road course use. Subjecting your vehicle to dedicated road course use even with these proposed precautions may render repairs non-reimbursable under the warranty.

Special Instructions

For your added safety, your vehicle is fitted with sophisticated electronic controls.

WARNINGS



You risk death or serious injury to yourself and others if you do not follow the instruction highlighted by the warning symbol. Failure to follow the specific warnings and instructions could result in personal injury.



Never place front seat mounted rear-facing child or infant seats in front of an active passenger airbag.

On Board Diagnostics Data Link Connector

WARNING



Do not connect wireless plug-in devices to the data link connector. Unauthorized third parties could gain access to vehicle data and impair the performance of safety related systems. Only allow repair facilities that follow our service and repair instructions to connect their equipment to the data link connector.

Your vehicle has an OBD Data Link Connector (DLC) that is used in conjunction with a diagnostic scan tool for vehicle diagnostics, repairs and reprogramming services. Installing an aftermarket device that uses the DLC during normal driving for purposes such as remote insurance company monitoring, transmission of vehicle data to other devices or entities, or altering the performance of the vehicle, may cause interference with or even damage to vehicle systems. We do not recommend or endorse the use of aftermarket plug-in devices unless approved by Ford. The vehicle Warranty will not cover damage caused by an aftermarket plug-in device.

Introduction

MOBILE COMMUNICATIONS EQUIPMENT

WARNING



Driving while distracted can result in loss of vehicle control, crash and injury. We strongly recommend that you use extreme caution when using any device that may take your focus off the road. Your primary responsibility is the safe operation of your vehicle. We recommend against the use of any hand-held device while driving and encourage the use of voice-operated systems when possible. Make sure you are aware of all applicable local laws that may affect the use of electronic devices while driving.

recommendations and specifications that are unique to your vehicle. This Owner's Manual is written primarily for the U.S. and Canadian Markets. Features or equipment listed as standard may be different on units built for export. **Refer to this Owner's Manual for all other required information and warnings.**

Using mobile communications equipment is becoming increasingly important in the conduct of business and personal affairs. However, you must not compromise your own or others' safety when using such equipment. Mobile communications can enhance personal safety and security when appropriately used, particularly in emergency situations. Safety must be paramount when using mobile communications equipment to avoid negating these benefits. Mobile communication equipment includes, but is not limited to, cellular phones, pagers, portable email devices, text messaging devices and portable two-way radios.

EXPORT UNIQUE OPTIONS

For your particular global region, your vehicle may be equipped with features and options that are different from the features and options that are described in this Owner's Manual. A market unique supplement may be supplied that complements this book. By referring to the market unique supplement, if provided, you can properly identify those features,

Environment

PROTECTING THE ENVIRONMENT

You must play your part in protecting the environment. Correct vehicle usage and the authorized disposal of waste, cleaning and lubrication materials are significant steps toward this aim.

At a Glance

INSTRUMENT PANEL OVERVIEW

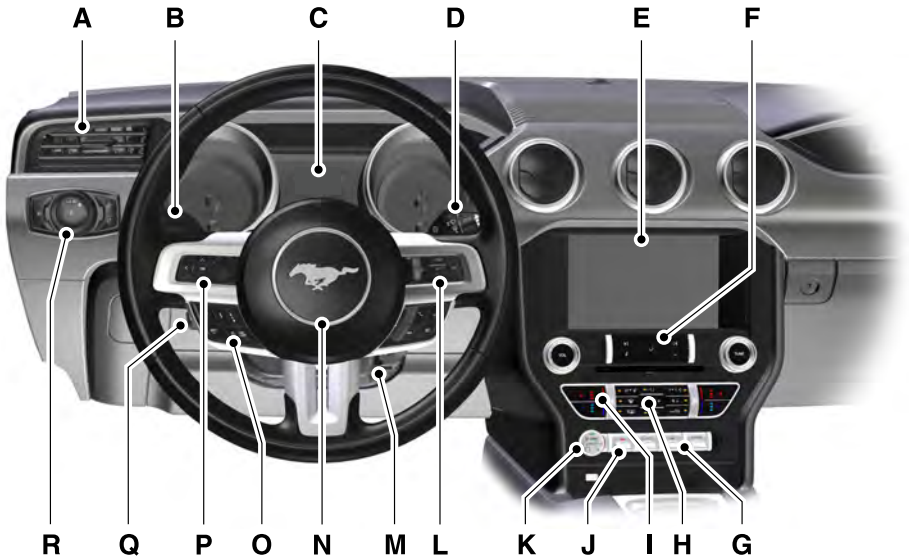

E206023

- A Air vents. See **Hints on Controlling the Interior Climate** (page 105).
- B Direction indicators. See **Direction Indicators** (page 71).
- C Instrument cluster. See **Instrument Cluster** (page 77).
- D Wiper lever. See **Wipers and Washers** (page 66).
- E Information and entertainment display. See **Information Displays** (page 83).
- F Audio unit. See **Audio System** (page 293).
- G Drive control switches. See **Drive Control** (page 170).
- H Climate controls. See **Climate Control** (page 102).
- I Climate controlled seats. See **Climate Controlled Seats** (page 114).
- J Hazard flasher switch. See **Hazard Flashers** (page 189).
- K Keyless start button. See **Keyless Starting** (page 122).
- L Audio control. See **Audio Control** (page 64).
- M Steering wheel adjustment. See **Adjusting the Steering Wheel** (page 64).

At a Glance

- N Horn.
- O Cruise control switches. See **Cruise Control** (page 155).
- P Information display controls. See **Information Display Control** (page 65).
- Q Luggage compartment release button. See **Locking and Unlocking** (page 56).
- R Lighting control. See **Lighting** (page 68).

Child Safety

GENERAL INFORMATION

See the following sections for directions on how to properly use safety restraints for children.

WARNINGS



Always make sure your child is secured properly in a device that is appropriate for their height, age and weight. Child safety restraints must be bought separately from your vehicle. Failure to follow these instructions and guidelines may result in an increased risk of serious injury or death to your child.



All children are shaped differently. The National Highway Traffic Safety Administration and other safety organizations, base their recommendations for child restraints on probable child height, age and weight thresholds, or on the minimum requirements of the law. We recommend that you check with a NHTSA Certified Child Passenger Safety

WARNINGS

Technician (CPST) to make sure that you properly install the child restraint in your vehicle and that you consult your pediatrician to make sure you have a child restraint appropriate for your child. To locate a child restraint fitting station and CPST, contact NHTSA toll free at 1-888-327-4236 or go to www.nhtsa.dot.gov. In Canada, contact Transport Canada toll free at 1-800-333-0371 or go to www.tc.gc.ca to find a Child Car Seat Clinic in your area. Failure to properly restrain children in child restraints made especially for their height, age and weight, may result in an increased risk of serious injury or death to your child.



On hot days, the temperature inside the vehicle can rise very quickly. Exposure of people or animals to these high temperatures for even a short time can cause death or serious heat related injuries, including brain damage. Small children are particularly at risk.

Child Safety

Recommendations for Safety Restraints for Children

Child	Child size, height, weight, or age	Recommended restraint type
Infants or toddlers	Children weighing 40 lb (18 kg) or less (generally age four or younger).	Use a child safety seat (sometimes called an infant carrier, convertible seat, or toddler seat).
Small children	Children who have outgrown or no longer properly fit in a child safety seat (generally children who are less than 4 ft. 9 in. (1.45 m) tall, are greater than age four and less than age 12, and between 40 lb (18 kg) and 80 lb (36 kg) and upward to 100 lb (45 kg) if recommended by your child restraint manufacturer).	Use a belt-positioning booster seat.
Larger children	Children who have outgrown or no longer properly fit in a belt-positioning booster seat (generally children who are at least 4 ft. 9 in. (1.45 m) tall or greater than 80 lb (36 kg) or 100 lb (45 kg) if recommended by child restraint manufacturer).	Use a vehicle safety belt having the lap belt snug and low across the hips, shoulder belt centered across the shoulder and chest, and seatback upright.

- You are required by law to properly use safety seats for infants and toddlers in the United States and Canada.
- Many states and provinces require that small children use approved booster seats until they reach age eight, a height of 4 feet 9 inches (1.45 meters) tall, or 80 lb (36 kg). Check your local and state or provincial laws for specific requirements about the safety of children in your vehicle.
- When possible, always properly restrain children 12 years of age and under in a rear seating position of your vehicle. Accident statistics suggest that children are safer when properly restrained in the rear seating positions than in a front seating position. See **Front Passenger Sensing System** (page 39).

INSTALLING CHILD RESTRAINTS

Child Seats



E142594

Child Safety

Use a child safety seat (sometimes called an infant carrier, convertible seat, or toddler seat) for infants, toddlers, or children weighing 40 pounds (18 kilograms) or less (generally age four or younger).

Using Lap and Shoulder Belts

WARNINGS

 Airbags can kill or injure a child in a child seat. Never place a rear-facing child seat in front of an active airbag. If you must use a forward-facing child seat in the front seat, move the seat upon which the child seat is installed all the way back.

 Airbags can kill or injure a child in a child seat. Children 12 and under should be properly restrained in the rear seat whenever possible.

 Depending on where you secure a child restraint, and depending on the child restraint design, you may block access to certain seatbelt buckle assemblies and LATCH lower anchors, rendering those features potentially unusable. To avoid risk of injury, occupants should only use seating positions where they are able to be properly restrained.

When installing a child safety seat with combination lap and shoulder belts:

- Use the correct seatbelt buckle for that seating position.
- Insert the belt tongue into the proper buckle until you hear a snap and feel it latch. Make sure the tongue is securely fastened in the buckle.
- Keep the buckle release button pointing up and away from the safety seat, with the tongue between the child seat and the release button, to prevent accidental unbuckling.

- Place the vehicle seat upon which the child seat will be installed in the upright position.
- Put the seatbelt in the automatic locking mode. See Step 5. This vehicle does not require the use of a locking clip.

Perform the following steps when installing the child seat with combination lap and shoulder belts:

Note: *Although the child seat illustrated is a forward facing child seat, the steps are the same for installing a rear facing child seat.*



E142528

1. Position the child safety seat in a seat with a combination lap and shoulder belt.



E142529

Child Safety

2. Pull down on the shoulder belt and then grasp the shoulder belt and lap belt together.



E142530

3. While holding the shoulder and lap belt portions together, route the tongue through the child seat according to the child seat manufacturer's instructions. Be sure the belt webbing is not twisted.

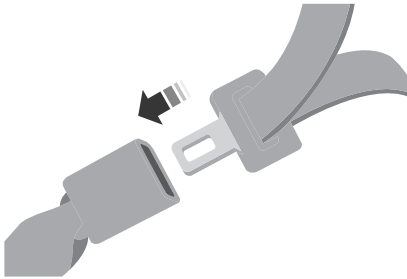

E142531

4. Insert the belt tongue into the proper buckle (the buckle closest to the direction the tongue is coming from) for that seating position until you hear a snap and feel the latch engage. Make sure the tongue is latched securely by pulling on it.



E142875

5. To put the retractor in the automatic locking mode, grasp the shoulder portion of the belt and pull downward until all of the belt is pulled out.

Note: *The automatic locking mode is available on the front passenger and rear seats. This vehicle does not require the use of a locking clip.*

6. Allow the belt to retract to remove slack. The belt will click as it retracts to indicate it is in the automatic locking mode.
7. Try to pull the belt out of the retractor to make sure the retractor is in the automatic locking mode (you should not be able to pull more belt out). If the retractor is not locked, unbuckle the belt and repeat Steps 5 and 6.



E142533

Child Safety

- Remove remaining slack from the belt. Force the seat down with extra weight, for example, by pressing down or kneeling on the child restraint while pulling up on the shoulder belt in order to force slack from the belt. This is necessary to remove the remaining slack that will exist once the extra weight of the child is added to the child restraint. It also helps to achieve the proper snugness of the child seat to your vehicle. Sometimes, a slight lean toward the buckle will additionally help to remove remaining slack from the belt.
- Attach the tether strap (if the child seat is equipped).

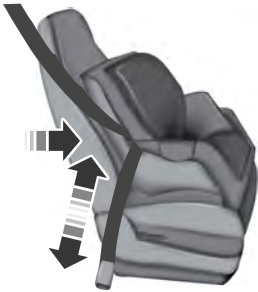

E142534

- Before placing the child in the seat, forcibly move the seat forward and back to make sure the seat is securely held in place. To check this, grab the seat at the belt path and attempt to move it side to side and forward and back. There should be no more than 1 inch (2.5 centimeters) of movement for proper installation.

We recommend checking with a NHTSA Certified Child Passenger Safety Technician to make certain the child restraint is properly installed. In Canada, check with Transport Canada for referral to a Child Car Seat Clinic.

Using Lower Anchors and Tethers for Children (LATCH)

WARNINGS

 Never attach two child safety seats to the same anchor. In a crash, one anchor may not be strong enough to hold two child safety seat attachments and may break, causing serious injury or death.

 Depending on where you secure a child restraint, and depending on the child restraint design, you may block access to certain seatbelt buckle assemblies or LATCH lower anchors, rendering those features potentially unusable. To avoid risk of injury, occupants should only use seating positions where they are able to be properly restrained.

 The center of the rear seat is not designed as a seating position and is not equipped with seatbelts. The LATCH anchors were not designed to be used with a child seat in the center position and there is no tether anchor available at the center. Attempted use of the center as a seating position will increase the risk of injury or death in the event of a crash.

The LATCH system is composed of three vehicle anchor points: two lower anchors located where seat back and seat cushion meet (called the seat bight) and one top tether anchor located behind that seating position.

LATCH compatible child safety seats have two rigid or webbing mounted attachments that connect to the two lower anchors at the LATCH equipped seating positions in your vehicle. This type of attachment method eliminates the need to use seatbelts to attach the child seat,

Child Safety

however the seatbelt can still be used to attach the child seat. For forward-facing child seats, the top tether strap must also be attached to the proper top tether anchor, if a top tether strap has been provided with your child seat.

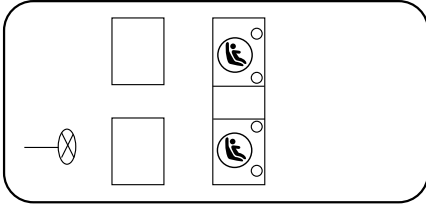

E174449

Your vehicle has LATCH lower anchors for child seat installation at the seating positions marked with the child seat symbol.

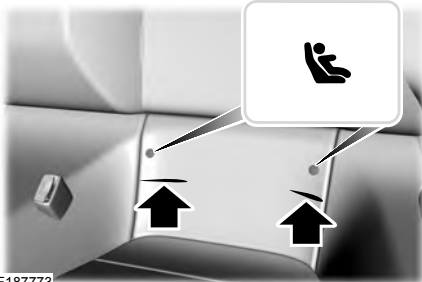

E187773

The LATCH anchors are located at the rear section of the rear seat between the cushion and seatback below the symbols as shown. Follow the child seat manufacturer's instructions to properly install a child seat with LATCH attachments. Follow the instructions on attaching child safety seats with tether straps.

Attach LATCH lower attachments of the child seat only to the anchors shown.

Combining Seatbelt and LATCH Lower Anchors for Attaching Child Safety Seats

When used in combination, either the seatbelt or the LATCH lower anchors may be attached first, provided a proper installation is achieved. Attach the tether strap afterward, if included with the child seat.

Using Tether Straps



Many forward-facing child safety seats include a tether strap which extends from the back of the child safety seat and hooks to an anchoring point called the top tether anchor. Tether straps are available as an accessory for many older safety seats.

Contact the manufacturer of your child seat for information about ordering a tether strap, or to obtain a longer tether strap if the tether strap on your safety seat does not reach the appropriate top tether anchor in your vehicle.

Once the child safety seat has been installed using either the seatbelt, the lower anchors of the LATCH system, or both, you can attach the top tether strap.

The tether strap anchors in your vehicle are in the following positions (shown from top view):

Child Safety

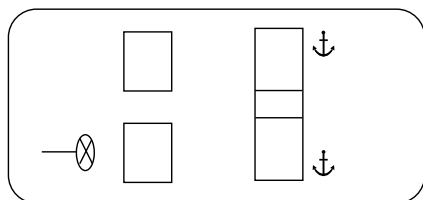

E174399

Perform the following steps to install a child safety seat with tether anchors:

For coupe:

Note: *If you install a child seat with rigid LATCH attachments, do not tighten the tether strap enough to lift the child seat off your vehicle seat cushion when the child is seated in it. Keep the tether strap just snug without lifting the front of the child seat. Keeping the child seat just touching your vehicle seat gives the best protection in a severe crash.*

1. Route the tether strap over the top of the seatback.



E174400

2. Locate the correct anchor for the selected seating position.
3. Open the tether anchor cover.



E174401

4. Clip the tether strap to the anchor as shown.
5. Tighten the child safety seat tether strap according to the manufacturer's instructions. If your child restraint system is equipped with a tether strap, and the child restraint manufacturer recommends its use, we also recommend its use.

If the safety seat is not anchored properly, the risk of a child being injured in a crash greatly increases.

For convertible:

Note: *For easier access, attach the tether with the convertible top up.*

1. Route the child safety seat tether strap over the top of the seatback.

Child Safety

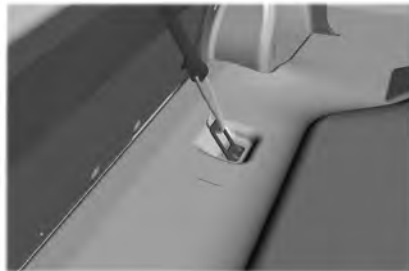
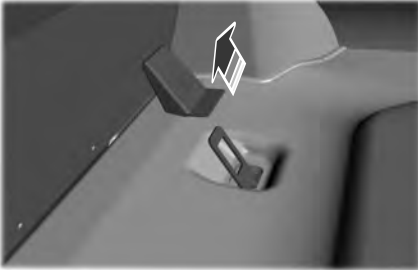

E185416

2. Access the tether anchors located behind the seatback.
3. Remove the tether anchor cap.
4. Clip the tether strap to the anchor.
5. Tighten the child safety seat tether strap according to the manufacturer's instructions.

If the safety seat is not anchored properly, the risk of a child being injured in a crash greatly increases.

If your child restraint system is equipped with a tether strap, and the child restraint manufacturer recommends its use, we also recommend its use.

BOOSTER SEATS

WARNING



Never place, or allow a child to place, the shoulder belt under a child's arm or behind the back because it reduces the protection for the upper part of the body and may increase the risk of injury or death in a crash.

Use a belt-positioning booster seat for children who have outgrown or no longer properly fit in a child safety seat (generally children who are less than 4 feet 9 inches (1.45 meters) tall, are greater than age four (4) and less than age twelve (12), and between 40 pounds (18 kilograms) and 80 pounds (36 kilograms) and upward to 100 pounds (45 kilograms) if recommended by your child restraint manufacturer). Many state and provincial laws require that children use approved booster seats until they reach age eight, a height of 4 feet 9 inches (1.45 meters) tall, or 80 pounds (36 kilograms).

Booster seats should be used until you can answer YES to ALL of these questions when seated without a booster seat:

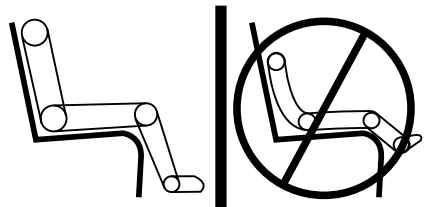

E142595

Child Safety

- Can the child sit all the way back against their vehicle seat back with knees bent comfortably at the edge of the seat cushion?
- Can the child sit without slouching?
- Does the lap belt rest low across the hips?
- Is the shoulder belt centered on the shoulder and chest?
- Can the child stay seated like this for the whole trip?

Always use booster seats in conjunction with your vehicle lap and shoulder belt.

Types of Booster Seats



E68924

- Backless booster seats

If your backless booster seat has a removable shield, remove the shield. If a vehicle seating position has a low seat back or no head restraint, a backless booster seat may place your child's head (as measured at the tops of the ears) above the top of the seat. In this case, move the backless booster to another seating position with a higher seat back or head restraint and lap and shoulder belts, or consider using a high back booster seat.



E70710

- High back booster seats

If, with a backless booster seat, you cannot find a seating position that adequately supports your child's head, a high back booster seat would be a better choice.

Children and booster seats vary in size and shape. Choose a booster that keeps the lap belt low and snug across the hips, never up across the stomach, and lets you adjust the shoulder belt to cross the chest and rest snugly near the center of the shoulder. The following drawings compare the ideal fit (center) to a shoulder belt uncomfortably close to the neck and a shoulder belt that could slip off the shoulder. The drawings also show how the lap belt should be low and snug across the child's hips.

Child Safety



E142596



E142597

If the booster seat slides on the vehicle seat upon which it is being used, placing a rubberized mesh sold as shelf or carpet liner under the booster seat may improve this condition. Do not introduce any item thicker than this under the booster seat. Check with the booster seat manufacturer's instructions.

CHILD RESTRAINT POSITIONING

WARNINGS



Airbags can kill or injure a child in a child seat. Never place a rear-facing child seat in front of an active airbag. If you must use a forward-facing child seat in the front seat, move the vehicle seat upon which the child seat is installed all

WARNINGS

the way back. When possible, all children age 12 and under should be properly restrained in a rear seating position. If all children cannot be seated and restrained properly in a rear seating position, properly restrain the largest child in the front seat.



Always carefully follow the instructions and warnings provided by the manufacturer of any child restraint to determine if the restraint device is appropriate for your child's size, height, weight, or age. Follow the child restraint manufacturer's instructions and warnings provided for installation and use in conjunction with the instructions and warnings provided by your vehicle

Child Safety

WARNINGS

manufacturer. A safety seat that is improperly installed or utilized, is inappropriate for your child's height, age, or weight or does not properly fit the child may increase the risk of serious injury or death.



Never let a passenger hold a child on his or her lap while your vehicle is moving. The passenger cannot protect the child from injury in a crash, which may result in serious injury or death.



Never use pillows, books, or towels to boost a child. They can slide around and increase the likelihood of injury or death in a crash.

WARNINGS



Always restrain an unoccupied child seat or booster seat. These objects may become projectiles in a crash or sudden stop, which may increase the risk of serious injury.



Never place, or allow a child to place, the shoulder belt under a child's arm or behind the back because it reduces the protection for the upper part of the body and may increase the risk of injury or death in a crash.



To avoid risk of injury, do not leave children or pets unattended in your vehicle.

Recommendations for attaching child safety restraints for children

Restraint Type	Combined weight of child and child seat	Use any attachment method as indicated below by X				
		LATCH (lower anchors and top tether anchor)	LATCH (lower anchors only)	Safety belt and top tether anchor	Safety belt and LATCH (lower anchors and top tether anchor)	Safety belt only
Rear facing child seat	Up to 65 lb (29.5 kg)		X			X
Rear facing child seat	Over 65 lb (29.5 kg)					X
Forward facing child seat	Up to 65 lb (29.5 kg)	X		X	X	
Forward facing child seat	Over 65 lb (29.5 kg)			X	X	

Note: The child seat must rest tightly against the vehicle seat upon which it is installed. It may be necessary to lift or remove the head restraint. See **Seats** (page 109).

Seatbelts

PRINCIPLE OF OPERATION

WARNINGS



Always drive and ride with your seatback upright and the lap belt snug and low across the hips.



To reduce the risk of injury, make sure children sit where they can be properly restrained.



Never let a passenger hold a child on his or her lap while your vehicle is moving. The passenger cannot protect the child from injury in a crash.



All occupants of your vehicle, including the driver, should always properly wear their safety belts, even when an airbag supplemental restraint system is provided. Failure to properly wear your safety belt could seriously increase the risk of injury or death.



It is extremely dangerous to ride in a cargo area, inside or outside of a vehicle. In a crash, people riding in these areas are more likely to be seriously injured or killed. Do not allow people to ride in any area of your vehicle that is not equipped with seats and safety belts. Be sure everyone in your vehicle is in a seat and using a safety belt properly.



In a rollover crash, an unbelted person is significantly more likely to die than a person wearing a safety belt.



Each seating position in your vehicle has a specific safety belt assembly which is made up of one buckle and one tongue that are designed to be used as a pair. 1) Use the shoulder belt on the outside shoulder only. Never wear the shoulder belt under the arm. 2) Never swing the safety belt around your neck over the inside shoulder. 3) Never use a single belt for more than one person.

WARNINGS



When possible, all children 12 years old and under should be properly restrained in a rear seating position. Failure to follow this could seriously increase the risk of injury or death.



Safety belts and seats can become hot in a vehicle that has been closed up in sunny weather; they could burn a small child. Check seat covers and buckles before you place a child anywhere near them.



Front and rear seat occupants, including pregnant women, should wear safety belts for optimum protection in an accident.



The center of the rear seat is not designed as a seating position and is not equipped with safety belts. The LATCH anchors were not designed to be used with a child seat in the center position and there is no tether anchor available at the center. Attempted use of the center as a seating position will increase the risk of injury or death in the event of a crash.

All seating positions in your vehicle have lap and shoulder safety belts. All occupants of the vehicle should always properly wear their safety belts, even when an airbag supplemental restraint system is provided.

The safety belt system consists of:

- Lap and shoulder safety belts.
- Safety belt pretensioner at the front outboard seating positions.
- Belt tension sensor at the front outboard passenger seating position.



• Safety belt warning light and chime.



• Crash sensors and monitoring system with readiness indicator.

Seatbelts

The safety belt pretensioners at the front seating positions are designed to tighten the safety belts when activated. In frontal and near-frontal crashes, the safety belt pretensioners may be activated alone or, if the crash is of sufficient severity, together with the front airbags. The pretensioners may also activate when a side curtain airbag is deployed.

FASTENING THE SEATBELTS

The front outboard and rear safety restraints in the vehicle are combination lap and shoulder belts.

A web guide is included on the outboard side of the front seats. Depending on occupant size and seating position, you may need to route the belt through the guide for a proper fit. If the seatbelt does not route across the middle of the shoulder, route the belt through the web guide.

Convertible



E175860

Coupe

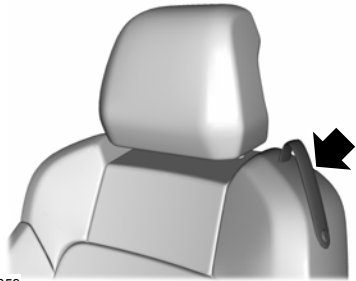

E175859

Recaro

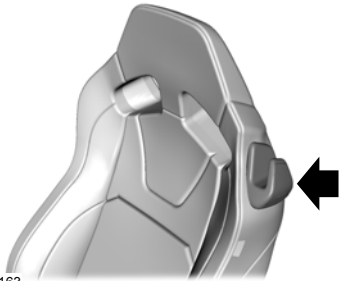

E175163

Recaro SVT

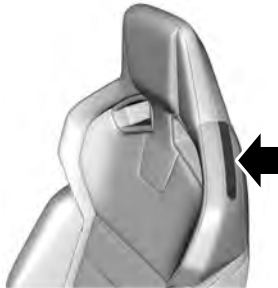

E216814

Seatbelts

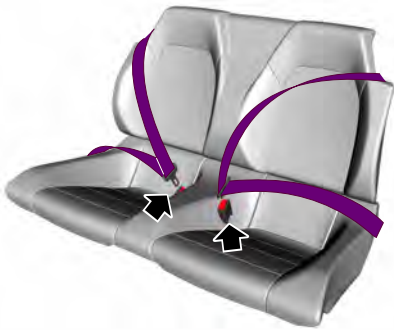

E204921



E142587

1. Insert the belt tongue into the proper buckle (the buckle closest to the direction the tongue is coming from) until you hear a snap and feel it latch. Make sure you securely fasten the tongue in the buckle.

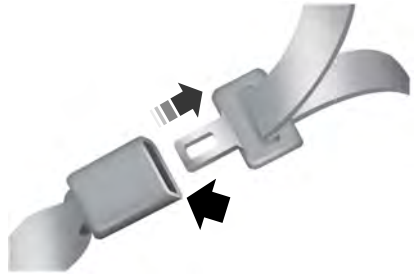

E142588

2. To unfasten, press the release button and remove the tongue from the buckle.

Using Seatbelts During Pregnancy

WARNING



Always ride and drive with your seatback upright and properly fasten your seatbelt. Fit the lap portion of the seatbelt snugly and low across the hips. Position the shoulder portion of the seatbelt across your chest. Pregnant women must follow this practice. See the following figure.



E142590

Seatbelts

Pregnant women should always wear their seatbelt. Position the lap belt portion of a combination lap and shoulder belt low across the hips below the belly and worn as tight as comfort allows. Position the shoulder belt to cross the middle of the shoulder and the center of the chest.

Seatbelt Locking Modes

WARNINGS



After a crash, have a qualified technician check all the seatbelts to make sure the seatbelts including the automatic locking retractor feature for child restraints operate properly. We recommend replacing any system that has damage or does not operate properly. Failure to do so can result in personal injury or death in the event of a sudden stop or another crash.



You must replace the seatbelt if the automatic locking retractor or any other seatbelt function is not operating correctly. Failure to replace the seatbelt and retractor assembly could increase the risk of injury in a crash.

All safety restraints in the vehicle are combination lap and shoulder belts and have vehicle sensitive locking mode. In addition, the front outboard passenger and rear seat seatbelts have the automatic locking mode.

Vehicle Sensitive Mode

This is the normal retractor mode, which allows free shoulder belt length adjustment to your movements and locking in response to vehicle movement. For example, if the driver brakes suddenly or turns a corner sharply, or the vehicle receives an impact of about 5 mph (8 km/h) or more, the combination seatbelts lock to help reduce forward movement of the driver and passengers.

In addition, the retractor is designed to lock if you pull the webbing out too quickly. If the seatbelt retractor locks, slowly lower the height adjuster to allow the seatbelt to retract. If the retractor does not unlock, pull the seatbelt out slowly then feed a small length of webbing back toward the stowed position. For rear seatbelts, recline the rear seat backrest or push the seat backrest cushion away from the seatbelt. Feed a small length of webbing back toward the stowed position.

Automatic Locking Mode

In this mode, the shoulder belt automatically pre-locks. The belt still retracts to remove any slack in the shoulder belt. The automatic locking mode is not available on the driver seatbelt.

When to Use the Automatic Locking Mode

Use this mode any time a child safety seat, except a booster, is installed in passenger front or rear seating positions. Properly restrain children 12 years old and under in a rear seating position whenever possible. See **Child Safety** (page 18).

How to Disengage the Automatic Locking Mode

Unbuckle the combination lap and shoulder belt and allow it to retract completely to disengage the automatic locking mode and activate the vehicle sensitive (emergency) locking mode.

SEATBELT WARNING LAMP AND INDICATOR CHIME



This lamp illuminates and an audible warning will sound if the driver's safety belt has not been fastened when the vehicle's ignition is turned on.

Seatbelts

Conditions of operation

If...	Then...
The driver's safety belt is not buckled before the ignition switch is turned to the on position...	The safety belt warning light illuminates 1-2 minutes and the warning chime sounds 4-8 seconds.
The driver's safety belt is buckled while the indicator light is illuminated and the warning chime is sounding...	The safety belt warning light and warning chime turn off.
The driver's safety belt is buckled before the ignition switch is turned to the on position...	The safety belt warning light and indicator chime remain off.

SEATBELT REMINDER

Belt-Minder™

This feature supplements the safety belt warning function by providing additional reminders that intermittently sound a tone and illuminate the safety belt warning light when you are in the driver seat or you have a front seat passenger and a safety belt is unbuckled.

The system uses information from the front passenger sensing system to determine if a front seat passenger is present and therefore potentially in need of a warning. To avoid activating the Belt-Minder feature for objects you place in the front passenger seat, only the front seat passengers receive warnings as determined by the front passenger sensing system.

If the Belt-Minder warnings expire (warnings for about five minutes) for one passenger (driver or front passenger), the other passenger can still cause the Belt-Minder feature to turn on.

Seatbelts

If...	Then...
You and the front seat passenger buckle your safety belts before you switch the ignition on or less than 1-2 minutes elapse after you switch the ignition on...	The Belt-Minder feature will not activate.
You or the front seat passenger do not buckle your safety belts before your vehicle reaches at least 6 mph (9.7 km/h) and 1-2 minutes elapse after you switch the ignition on...	The Belt-Minder feature activates, the safety belt warning light illuminates and a warning tone sounds for 6 seconds every 25 seconds, repeating for about 5 minutes or until you and the front seat passenger buckle your safety belts.
The safety belt for the driver or front passenger is unbuckled for about 1 minute while the vehicle is traveling at least 6 mph (9.7 km/h) and more than 1-2 minutes elapse after you switch the ignition on...	The Belt-Minder feature activates, the safety belt warning light illuminates and a warning tone sounds for 6 seconds every 25 seconds, repeating for about 5 minutes or until you and the front seat passenger buckle your safety belts.

Deactivating and Activating the Belt-Minder Feature

WARNING



While the system allows you to deactivate it, this system is designed to improve your chances of being safely belted and surviving an accident. We recommend you leave the system activated for yourself and others who may use the vehicle.

Note: *The driver and front passenger warnings switch on and off independently. When you perform this procedure for one seating position, do not buckle the other position as this will terminate the process.*

Note: *If you are using MyKey, you cannot disable the Belt-Minder. Also, if you have previously disabled the Belt-Minder, it will be re-enabled during the use of MyKey.*

Read Steps 1 - 4 thoroughly before proceeding with the programming procedure.

Before following the procedure, make sure that:

- The parking brake is set.
 - The transmission is in park (P) (automatic transmission) or neutral (N) (manual transmission).
 - The ignition is off.
 - The driver and front passenger safety belts are unbuckled.
1. Switch the ignition on. Do not start the vehicle.
 2. Wait until the safety belt warning light turns off (about one minute). After Step 2, wait an additional 5 seconds before proceeding with Step 3. Once you start Step 3, you must complete the procedure within 30 seconds.
 3. For the seating position you are switching off, buckle then unbuckle the safety belt three times at a moderate speed, ending in the unbuckled state. After Step 3, the safety belt warning light turns on.

Seatbelts

4. While the safety belt warning light is on, buckle and then unbuckle the safety belt. After Step 4, the safety belt warning light flashes for confirmation.
 - This will switch the feature off for that seating position if it is currently on.
 - This will switch the feature on for that seating position if it is currently off.

CHILD RESTRAINT AND SEATBELT MAINTENANCE

Inspect the vehicle safety belts and child safety seat systems periodically to make sure they work properly and are not damaged. Inspect the vehicle and child seat safety belts to make sure there are no nicks, tears or cuts. Replace if necessary. All vehicle safety belt assemblies, including retractors, buckles, front safety belt buckle assemblies, buckle support assemblies (slide bar-if equipped), shoulder belt height adjusters (if equipped), shoulder belt guide on seat back (if equipped), child safety seat LATCH and tether anchors, and attaching hardware, should be inspected after a crash. Read the child restraint manufacturer's instructions for additional inspection and maintenance information specific to the child restraint.

Ford Motor Company recommends that all safety belt assemblies in use in vehicles involved in a crash be replaced. However, if the crash was minor and an authorized dealer finds that the belts do not show damage and continue to operate properly, they do not need to be replaced. Safety belt assemblies not in use during a crash should also be inspected and replaced if either damage or improper operation is noted.

Properly care for safety belts. See **Vehicle Care** (page 230).

SEATBELT EXTENSION

WARNINGS



Persons who fit into the vehicle's seatbelt should not use an extension. Unnecessary use could result in serious personal injury in the event of a crash.



Only use extensions provided free of charge by Ford Motor Company dealers. The dealer will provide an extension designed specifically for this vehicle, model year and seating position. The use of an extension intended for another vehicle, model year or seating position may not offer you the full protection of your vehicle's seatbelt restraint system.



Never use seatbelt extensions to install child restraints.



Do not use a seatbelt extension with an inflatable seatbelt.



Do not use extensions to change the fit of the belt across the torso, over the lap or to make the seatbelt buckle easier to reach.

If, because of body size or driving position, it is not possible to properly fasten the seatbelt over your lap and shoulder, an extension that is compatible with the seatbelts is available free of charge from Ford Motor Company dealers. Only Ford seatbelt extensions made by the original equipment seatbelts manufacturer should be used with Ford seatbelts. Ask your authorized dealer if your extension is compatible with your Ford vehicle restraint system.

Personal Safety System™

The Personal Safety System provides an improved overall level of frontal crash protection to front seat occupants and is designed to help further reduce the risk of airbag-related injuries. The system is able to analyze different occupant conditions and crash severity before activating the appropriate safety devices to help better protect a range of occupants in a variety of frontal crash situations.

The Vehicle Personal Safety System consists of:

- Driver and passenger dual-stage airbag supplemental restraints.
- Front seat outboard safety belts with pretensioners, energy management retractors and safety belt usage sensors.
- Driver seat position sensor.
- Front passenger sensing system.
- Passenger airbag off and on indicator lamp.
- Front crash severity sensors.
- Restraints control module with impact and safing sensors.
- Restraint system warning light and backup tone.
- The electrical wiring for the airbags, crash sensors, safety belt pretensioners, front safety belt usage sensors, driver seat position sensor, front passenger sensing system and indicator lights.

How Does the Personal Safety System Work?

The Personal Safety System can adapt the deployment strategy of the safety devices according to crash severity and occupant conditions. A collection of crash and occupant sensors provides information to the restraints control module. During a crash, the restraints control module may deploy the safety belt pretensioners, one or both stages of the dual-stage airbags based on crash severity and occupant conditions.

Supplementary Restraints System

PRINCIPLE OF OPERATION

WARNINGS

 Airbags do not inflate slowly or gently, and the risk of injury from a deploying airbag is the greatest close to the trim covering the airbag module.

 All occupants of your vehicle, including the driver, should always properly wear their safety belts, even when an airbag supplemental restraint system is provided. Failure to properly wear your safety belt could seriously increase the risk of injury or death.

 Always transport children 12 years old and under in the back seat and always properly use appropriate child restraints. Failure to follow this could seriously increase the risk of injury or death.

 Never place your arm over the airbag module as a deploying airbag can result in serious arm fractures or other injuries.

 Airbags can kill or injure a child in a child seat. Never place a rear-facing child seat in front of an active airbag. If you must use a forward-facing child seat in the front seat, move the seat upon which the child seat is installed all the way back.

 Do not attempt to service, repair, or modify the airbag supplemental restraint systems or its fuses as you could be seriously injured or killed. Contact your authorized dealer as soon as possible.

 Several airbag system components get hot after inflation. To reduce the risk of injury, do not touch them after inflation.

 If the airbag has deployed, the airbag will not function again and must be replaced immediately. If the airbag is not replaced, the unrepaired area will increase the risk of injury in a crash.

The airbags are a supplemental restraint system and are designed to work with the safety belts to help protect the driver and right front passenger from certain upper body injuries. Airbags do not inflate slowly; there is a risk of injury from a deploying airbag.

Note: *You will hear a loud bang and see a cloud of harmless powdery residue if an airbag deploys. This is normal.*

The airbags inflate and deflate rapidly upon activation. After airbag deployment, it is normal to notice a smoke-like, powdery residue or smell the burnt propellant. This may consist of cornstarch, talcum powder (to lubricate the bag) or sodium compounds (for example, baking soda) that result from the combustion process that inflates the airbag. Small amounts of sodium hydroxide may be present which may irritate the skin and eyes, but none of the residue is toxic.

While the system is designed to help reduce serious injuries, contact with a deploying airbag may also cause abrasions or swelling. Temporary hearing loss is also a possibility as a result of the noise associated with a deploying airbag. Because airbags must inflate rapidly and with considerable force, there is the risk of death or serious injuries such as fractures, facial and eye injuries or internal injuries, particularly to occupants who are not properly restrained or are otherwise out of position at the time of airbag deployment. Thus, it is extremely important that occupants be properly restrained as far away from the airbag module as possible while maintaining vehicle control.

Routine maintenance of the airbags is not required.

Supplementary Restraints System

DRIVER AND PASSENGER AIRBAGS

WARNINGS



Never place your arm or any objects over an airbag module. Placing your arm over a deploying airbag can result in serious arm fractures or other injuries. Objects placed on or over the airbag inflation area may cause those objects to be propelled by the airbag into your face and torso causing serious injury.



Airbags can kill or injure a child in a child seat. Never place a rear-facing child seat in front of an active airbag. If you must use a forward-facing child seat in the front seat, move the seat upon which the child seat is installed all the way back.

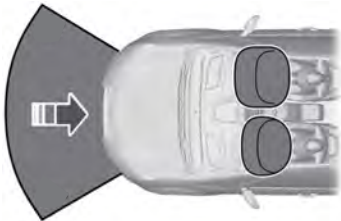

E151127

The driver and front passenger airbags will deploy during significant frontal and near frontal crashes.

The driver and passenger front airbag system consists of:

- Driver and passenger airbag modules.
- Front passenger sensing system.



• Crash sensors and monitoring system with readiness indicator. See **Crash Sensors and Airbag Indicator** (page 44).

Proper Driver and Front Passenger Seating Adjustment

WARNING



National Highway Traffic Safety Administration (NHTSA) recommends a minimum distance of at least 10 inches (25 centimeters) between an occupant's chest and the driver airbag module.

To properly position yourself away from the airbag:

- Move your seat to the rear as far as you can while still reaching the pedals comfortably.
- Recline the seat slightly (one or two degrees) from the upright position.

After all occupants have adjusted their seats and put on safety belts, it is very important that they continue to sit properly. A properly seated occupant sits upright, leaning against the seat back, and centered on the seat cushion, with their feet comfortably extended on the floor. Sitting improperly can increase the chance of injury in a crash event. For example, if an occupant slouches, lies down, turns sideways, sits forward, leans forward or sideways, or puts one or both feet up, the chance of injury during a crash is greatly increased.

Children and Airbags

WARNING



Airbags can kill or injure a child in a child seat. Never place a rear-facing child seat in front of an active airbag. If you must use a forward-facing child seat in the front seat, move the seat upon which the child seat is installed all the way back.

Supplementary Restraints System



E142846

Children must always be properly restrained. Accident statistics suggest that children are safer when properly restrained in the rear seating positions than in the front seating position. Failure to follow these instructions may increase the risk of injury in a crash.

FRONT PASSENGER SENSING SYSTEM

WARNINGS



Even with Advanced Restraints Systems, children 12 and under should be properly restrained in a rear seating position. Failure to follow this could seriously increase the risk of injury or death.



Sitting improperly out of position or with the seat back reclined too far can take off weight from the seat cushion and affect the decision of the front passenger sensing system, resulting in serious injury or death in a crash. Always sit upright against your seatback, with your feet on the floor.

WARNINGS



To reduce the risk of possible serious injury: Do not stow objects in seatback map pocket or hang objects off seatback if a child is in the front passenger seat. Do not place objects underneath the front passenger seat or between the seat and the center console. Check the passenger airbag off indicator lamp for proper airbag status. Failure to follow these instructions may interfere with the front passenger sensing system.



Any alteration or modification to the front passenger seat may affect the performance of the front passenger sensing system.

This system works with sensors that are part of the front passenger seat and safety belt to detect the presence of a properly-seated occupant and determine if the front passenger frontal airbag should be enabled (may inflate) or not.



E179527

The front passenger sensing system uses a passenger airbag off indicator which will illuminate and stay lit to remind you that the front passenger frontal airbag is disabled.

The indicator lamp is located on the overhead console.

Supplementary Restraints System

Note: When the ignition is first turned on, the indicator lamp will illuminate for a short period of time to confirm it is functional.

The front passenger sensing system is designed to disable (will not inflate) the front passenger frontal airbag when a rear facing infant seat, a forward-facing child restraint, or a booster seat is detected. Even with this technology, parents are **strongly** encouraged to always properly restrain children in the rear seat. The sensor also turns off the passenger front airbag and seat-mounted side airbag when the passenger seat is empty.

- When the front passenger sensing system disables (will not inflate) the front passenger frontal airbag, the indicator lamp will illuminate and stay lit to remind you that the front passenger frontal airbag is disabled.
- If the child restraint has been installed and the indicator lamp is not lit, then turn the vehicle off, remove the child restraint from the vehicle and reinstall the restraint following the child restraint manufacturer's instructions.

The front passenger sensing system is designed to enable (may inflate) the front passenger frontal airbag anytime the system senses that a person of adult size is sitting properly in the front passenger seat.

- When the front passenger sensing system enables the front passenger frontal airbag (may inflate), the indicator lamp will be unlit and stay unlit.

If a person of adult size is sitting in the front passenger seat, but the airbag off indicator lamp is lit, it is possible that the person is not sitting properly in the seat. If this happens:

- Turn the vehicle off and ask the person to place the seat back in the full upright position.
- Have the person sit upright in the seat, centered on the seat cushion, with the person's legs comfortably extended.
- Restart the vehicle and have the person remain in this position for about two minutes. This will allow the system to detect that person and enable the passenger's frontal airbag.
- If the indicator lamp remains lit even after this, the person should be advised to ride in the rear seat.

Occupant	Passenger airbag OFF indicator	Passenger airbag
Empty	Unlit	Disabled
Child	Lit	Disabled
Adult	Unlit	Enabled

Note: When the front passenger airbag off light is illuminated, the passenger (seat mounted) side airbag may be disabled to avoid the risk of airbag deployment injuries.

After all occupants have adjusted their seats and put on safety belts, it is very important that they continue to sit properly. A properly seated occupant sits upright, leaning against the seat back, and centered on the seat cushion, with their

Supplementary Restraints System

feet comfortably extended on the floor. Sitting improperly can increase the chance of injury in a crash event. For example, if an occupant slouches, lies down, turns sideways, sits forward, leans forward or sideways, or puts one or both feet up, the chance of injury during a crash is greatly increased.

If you think that the status of the passenger airbag off indicator lamp is incorrect, check for the following:

- Objects lodged underneath the seat.
- Objects between the seat cushion and the center console.
- Objects hanging off the seatback.
- Objects stowed in the seatback map pocket.
- Objects placed on the occupant's lap.
- Cargo interference with the seat.
- Other passengers pushing or pulling on the seat.
- Rear passenger feet and knees resting or pushing on the seat.

The conditions listed above may cause the weight of a properly seated occupant to be incorrectly interpreted by the front passenger sensing system. The person in the front passenger seat may appear heavier or lighter due to the conditions described in the list above.



Make sure the front passenger sensing system is operating properly. See **Crash Sensors and Airbag Indicator** (page 44).

If the airbag readiness light is lit, do the following:

The driver and adult passengers should check for objects lodged underneath the front passenger seat, or cargo interfering with the seat.

If there are lodged objects, or cargo is interfering with the seat, take the following steps to remove the obstruction:

- Pull the vehicle over.
- Turn the vehicle off.
- Driver and adult passengers should check for any objects lodged underneath the front passenger seat or cargo interfering with the seat.
- Remove the obstruction(s) (if found).
- Restart the vehicle.
- Wait at least two minutes and verify that the airbag readiness light is no longer illuminated.
- If the airbag readiness light remains illuminated, this may or may not be a problem due to the front passenger sensing system.

Do not attempt to repair or service the system. Take your vehicle immediately to an authorized dealer.

If it is necessary to modify an advanced front airbag system to accommodate a person with disabilities, contact the Ford Customer Relationship Center. See **Getting the Services You Need** (page 194).

SIDE AIRBAGS

WARNINGS



Do not place objects or mount equipment on or near the airbag cover, on the side of the seatbacks (of the front seats), or in front seat areas that may come into contact with a deploying airbag. Failure to follow these instructions may increase the risk of personal injury in the event of a crash.

Supplementary Restraints System

WARNINGS



Do not use accessory seat covers. The use of accessory seat covers may prevent the deployment of the side airbags and increase the risk of injury in an accident.



Do not lean your head on the door. The side airbag could injure you as it deploys from the side of the seatback.



Do not attempt to service, repair, or modify the airbag, its fuses or the seat cover on a seat containing an airbag as you could be seriously injured or killed. Contact your authorized dealer as soon as possible.



If the side airbag has deployed, the airbag will not function again. The side airbag system (including the seat) must be inspected and serviced by an authorized dealer. If the airbag is not replaced, the unrepaired area will increase the risk of injury in a crash.

The side airbags are located on the outboard side of the seatbacks of the front seats. In certain sideways crashes, the airbag on the side affected by the crash will be inflated. The airbag was designed to inflate between the door panel and occupant to further enhance the protection provided occupants in side impact crashes.

Coupe



E152533

Convertible



E174777

The system consists of the following:

- A label or embossed side panel indicating that side airbags are fitted to your vehicle.
- Side airbags located inside the driver and front passenger seatbacks.
- Front passenger sensing system.



• Crash sensors and monitoring system with readiness indicator. See **Crash Sensors and Airbag Indicator** (page 44).

Indicator (page 44).

Note: *The passenger sensing system will deactivate the passenger seat-mounted side airbag if it detects an empty passenger seat.*

Supplementary Restraints System

The design and development of the side airbag system included recommended testing procedures that were developed by a group of automotive safety experts known as the Side Airbag Technical Working Group. These recommended testing procedures help reduce the risk of injuries related to the deployment of side airbags.

DRIVER AND PASSENGER KNEE AIRBAGS

WARNINGS



Keep the glove box door closed while driving for optimal performance of the passenger knee airbag during a crash.



To reduce risk of injury, do not obstruct or place objects in the deployment path of the knee airbag.

A driver knee airbag is located under or within the instrument panel. A passenger knee airbag is located within the glove box door. During a crash, the restraints control module may activate the driver and passenger knee airbags based on crash severity and occupant conditions. Under certain crash and occupant conditions, the driver and passenger knee airbag may deploy but the driver front airbag may not activate. As with front and side airbags, it is important to be properly seated and restrained to reduce the risk of death or serious injury.



Make sure the knee airbags are operating properly. See **Crash Sensors and Airbag Indicator**

(page 44).

SAFETY CANOPY™ - COUPE

WARNINGS



Do not place objects or mount equipment on or near the headliner at the siderail that may come into contact with a deploying curtain airbag. Failure to follow these instructions may increase the risk of personal injury in the event of a crash.



Do not lean your head on the door. The curtain airbag could injure you as it deploys from the headliner.



Do not attempt to service, repair, or modify the curtain airbag supplemental restraint system, its fuses, the A, B, or C pillar trim, or the headliner on a vehicle containing curtain airbags as you could be seriously injured or killed. Contact your authorized dealer as soon as possible.



All occupants of your vehicle, including the driver, should always properly wear their seatbelts, even when an airbag supplemental restraint system is provided. Failure to properly wear your seatbelt could seriously increase the risk of injury or death.



To reduce risk of injury, do not obstruct or place objects in the deployment path of the airbag.



If the curtain airbags have deployed, the curtain airbags will not function again. The curtain airbags (including the A, B and C pillar trim and headliner) must be inspected and serviced as soon as possible. If the curtain airbag is not replaced, the unrepaired area will increase the risk of injury in a crash.

Supplementary Restraints System

The Safety Canopy deploys during significant side crashes or when a certain likelihood of a rollover event is detected by the rollover sensor. The Safety Canopy is mounted to the roof side-rail sheet metal, behind the headliner, above each row of seats. In certain sideways crashes or rollover events, the Safety Canopy will be activated, regardless of which seats are occupied. The Safety Canopy is designed to inflate between the side window area and occupants to further enhance protection provided in side impact crashes and rollover events.

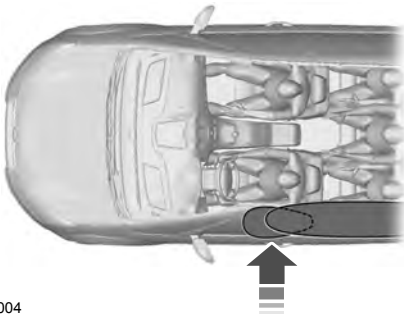

E75004

The system consists of the following:

- Safety Canopy curtain airbags located above the trim panels over the front and rear side windows identified by a label or wording on the headliner or roof-pillar trim.
- A flexible headliner which opens above the side doors to allow air curtain deployment



• Crash sensors and monitoring system with a readiness indicator. See **Crash Sensors and Airbag Indicator** (page 44).

Properly restrain children 12 years old and under in the rear seats. The Safety Canopy will not interfere with children restrained using a properly installed child or booster seat because it is designed to inflate downward from the headliner above the doors along the side window opening.

The design and development of the Safety Canopy included recommended testing procedures that were developed by a group of automotive safety experts known as the Side Airbag Technical Working Group. These recommended testing procedures help reduce the risk of injuries related to the deployment of side airbags (including the Safety Canopy).

CRASH SENSORS AND AIRBAG INDICATOR

WARNING



Modifying or adding equipment to the front end of the vehicle (including frame, bumper, front end body structure and tow hooks) may affect the performance of the airbag system, increasing the risk of injury. Do not modify the front end of the vehicle.

Your vehicle has a collection of crash and occupant sensors which provide information to the restraints control module. The restraints control module deploys (activates) the front safety belt pretensioners, driver airbag, passenger airbag, knee airbag(s), seat mounted side airbags and Safety Canopy airbags. Based on the type of crash (frontal impact or side impact), the restraints control module will deploy the appropriate safety devices.

Supplementary Restraints System

The restraints control module also monitors the readiness of the above safety devices plus the crash and occupant sensors. The readiness of the safety system is indicated by a warning indicator light in the instrument cluster or by a backup tone if the warning light is not working. Routine maintenance of the airbag is not required.

A difficulty with the system is indicated by one or more of the following:



The readiness light will not illuminate immediately after the ignition is turned on.

- The readiness light will either flash or stay lit.
- A series of five beeps will be heard. The tone pattern will repeat periodically until the problem, the light or both are repaired.

If any of these things happen, even intermittently, have the supplemental restraint system serviced at an authorized dealer immediately. Unless serviced, the system may not function properly in the event of a crash.

The safety belt pretensioners and the front airbag supplemental restraint system are designed to activate when the vehicle sustains frontal deceleration sufficient to cause the restraints control module to deploy a safety device.

The fact that the safety belt pretensioners or front airbags did not activate for both front seat occupants in a crash does not mean that something is wrong with the system. Rather, it means the restraints control module determined the accident conditions (crash severity, belt usage) were not appropriate to activate these safety devices.

- The design of the front airbags is to activate only in frontal and near-frontal crashes (not rollovers, side impacts or rear impacts unless the crash causes sufficient frontal deceleration).
- The safety belt pretensioners are designed to activate in frontal, near-frontal and side crashes.
- The knee airbag(s) may deploy based on crash severity and occupant conditions.
- The design of the side airbags is to inflate in certain side crashes. The design of the Safety Canopy is to inflate in certain side impact crashes and when a certain likelihood of rollover is detected by the rollover sensor. Side airbags and Safety Canopy airbags may activate in other types of crashes if the vehicle experiences sufficient sideways motion or deformation.

AIRBAG DISPOSAL

Contact your authorized dealer as soon as possible. Airbags must be disposed of by qualified personnel.

Keys and Remote Controls

GENERAL INFORMATION ON RADIO FREQUENCIES

This device complies with Part 15 of the FCC Rules and with Industry Canada license-exempt RSS standard(s). Operation is subject to the following two conditions: (1) This device may not cause harmful interference, and (2) This device must accept any interference received, including interference that may cause undesired operation.

Note: *Changes or modifications not expressly approved by the party responsible for compliance could void the user's authority to operate the equipment. The term IC before the radio certification number only signifies that Industry Canada technical specifications were met.*

The typical operating range for your transmitter is approximately 33 feet (10 meters). Vehicles with the remote start feature will have a greater range. One of the following could cause a decrease in operating range:

- weather conditions
- nearby radio towers
- structures around the vehicle
- other vehicles parked next to your vehicle

Other short-distance radio transmitters, such as amateur radios, medical equipment, wireless headphones, remote controls and alarm systems may operate on the same frequency as your remote control. If other transmitters are operating on those frequencies, you may not be able to use your remote control. Using your remote control near some types of electronic equipment, such as USB devices,

computers or cell phones can interfere with remote operation. Operating your remote control near metal or metallic-finished purses, bags or clothing can interfere with remote operation. You can lock and unlock the doors with the key.

Note: *Make sure to lock your vehicle before leaving it unattended.*

Note: *If you are in range, the remote control will operate if you press any button unintentionally.*

Intelligent Access

The system uses a radio frequency signal to communicate with your vehicle and authorize your vehicle to unlock when one of the following conditions are met:

- You touch the inside of any exterior door handle within 3 ft (1 m) proximity of an intelligent access key.
- You press the luggage compartment button.
- You press a button on the transmitter.

If excessive radio frequency interference is present in the area or if the transmitter battery is low, you may need to mechanically unlock your door. You can use the mechanical key blade in your intelligent access key to open the driver door in this situation. See **Remote Control** (page 47).

Keys and Remote Controls

REMOTE CONTROL

Intelligent Access Key



E144506

Your intelligent access keys operate the power locks and the remote start system. The key must be in your vehicle to activate the push-button start system.

Removable Key Blade

The intelligent access key also contains a removable mechanical key blade that you can use to unlock the driver door.

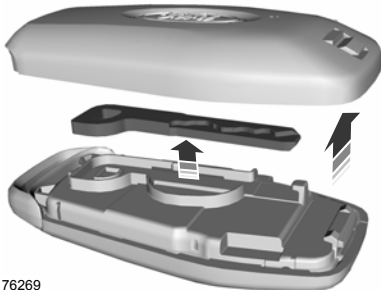

E176269

Slide the release on the back of the remote control and pivot the cover off to access the key blade.



E151795

Note: Your vehicle's backup keys came with a security tag that provides important vehicle key cut information. Keep the tag in a safe place for future reference.

Using the Key Blade

The key cylinder is under a cap on the driver door handle.

To remove the cap:

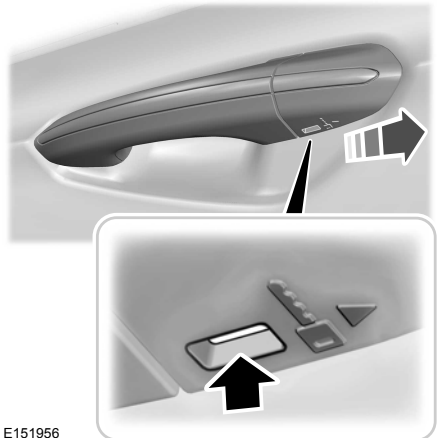

E151956

1. Insert the key blade into the slot on the bottom of the handle and press up.
2. While maintaining upward pressure, move the cap rearward to release it. Gently remove the key while doing so.

To install the cap:

Keys and Remote Controls



E151957

1. Place the cap just forward of the key cylinder.
2. While applying pressure to the cap, move it forward until it is in place. You may hear a snap as it engages.

Make sure you have properly installed the cap by trying to move it rearward.

Replacing the Battery

Note: Refer to local regulations when disposing of transmitter batteries.

Note: Do not wipe off any grease on the battery terminals or on the back surface of the circuit board.

Note: Replacing the battery will not delete the transmitter from the vehicle. The transmitter should operate normally.

A message will appear in the information display when the remote control battery is low. See **Information Messages** (page 91).

Intelligent Access Transmitter

The remote control uses two coin-type three-volt lithium batteries CR2025 or equivalent.



E151796

1. Slide the release on the back of the remote control and pivot the cover off.



E153890

2. Insert a coin into the slot and twist to separate the housing.

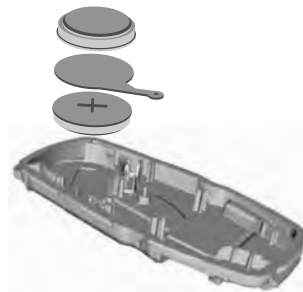

E176226

3. Remove the batteries.
4. Install new batteries with the + facing each other.

Keys and Remote Controls

Note: Make sure to replace the label between the two batteries.

5. Reinstall the housing and cover.

Car Finder



Press the button twice within three seconds. The horn will sound and the turn signals will flash. We recommend you use this method to locate your vehicle, rather than using the panic alarm.

Sounding a Panic Alarm

Note: The panic alarm will only operate when the ignition is off.



Press the button to activate the alarm. Press the button again or switch the ignition on to deactivate.

Remote Start

WARNING



To avoid exhaust fumes, do not use remote start if your vehicle is parked indoors or in areas that are not well ventilated.

Note: Do not use remote start if your vehicle is low on fuel.



The remote start button is on the transmitter.

This feature allows you to start your vehicle from outside the vehicle. The transmitter has an extended operating range.

Vehicles with automatic climate control can be configured to operate when the vehicle is remote started. See **Climate Control** (page 102). A manual climate control system will run at the setting it was set to when you switched the vehicle off.

Many states and provinces have restrictions for the use of remote start. Check your local and state or provincial laws for specific requirements regarding remote start systems.

The remote start system will not work if:

- the ignition is on
- the alarm system is triggered
- you disable the feature
- the hood is open
- the transmission is not in **P**
- the vehicle battery voltage is too low
- the service engine soon light is on.

Remote Control Feedback

An LED on the remote control provides status feedback of remote start or stop commands.

LED	Status
Solid green	Remote start or extension successful
Solid red	Remote stop successful; engine off
Blinking red	Remote start or stop failed
Blinking green	Waiting for status update

Remote Starting the Vehicle

Note: You must press each button within three seconds of each other. Your vehicle will not remote start if you do not follow this sequence.

Keys and Remote Controls

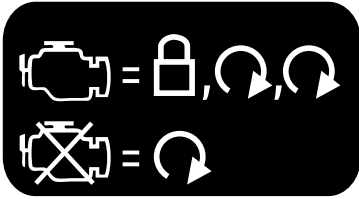

E138626

The tag with your transmitter details the starting procedure.

To remote start your vehicle:

1. Press the lock button to lock all the doors.
2. Press the remote start button twice. The exterior lamps will flash twice.

The horn will sound if the system fails to start, unless quiet start is on. Quiet start will run the blower fan at a slower speed to reduce noise. It can be switched on or off in the information display. See **General Information** (page 83).

Note: You must press the **START/STOP** button on the instrument panel once while applying the brake pedal before driving your vehicle.

The power windows will not work during the remote start and the radio will not turn on automatically.

The parking lamps will remain on and the vehicle will run for 5, 10, or 15 minutes, depending on the setting.

Extending the Vehicle Run Time

Repeat Steps 1 and 2 with the vehicle still running to extend the run time for another remote start duration. If you programmed the duration to last 10 minutes, the second 10 minutes will begin after what is left of the first activation time. For example, if the vehicle had been running from the first remote start for five minutes, the vehicle will continue to run now for a total of 15 minutes. You can extend the remote start up to a maximum of 35 minutes.

Wait at least five seconds before remote starting after a vehicle shutdown.

Turning the Vehicle Off After Remote Starting



Press the button once. The parking lamps will turn off.

You may have to be closer to the vehicle than when starting due to ground reflection and the added noise of the running vehicle.

You can disable or enable the remote start system through the information display. See **General Information** (page 83).

Memory Feature (If Equipped)

You can use the remote control to recall memory positions. If programmed to a pre-set position, the remote control recalls memory positions when you unlock your vehicle. See **Memory Function** (page 112).

REPLACING A LOST KEY OR REMOTE CONTROL

Replacement keys or remote controls can be purchased from an authorized dealer. Authorized dealers can program remote controls for your vehicle. See **Passive Anti-Theft System** (page 62).

PRINCIPLE OF OPERATION

MyKey allows you to program keys with restricted driving modes to promote good driving habits. All but one of the keys programmed to the vehicle can be activated with these restricted modes.

Any keys that have not been programmed are referred to as administrator keys or admin keys. These can be used to:

- Create a MyKey.
- Program configurable MyKey settings.
- Clear all MyKey features.

When you have programmed a MyKey, you can access the following information using the information display:

- How many admin keys and MyKeys are programmed to your vehicle.
- The total distance your vehicle has traveled using a MyKey.

Note: All MyKeys are programmed to the same settings. You cannot program them individually.

Note: For vehicles with intelligent access with push-button start, when both a MyKey and an admin intelligent access key fob are present, the admin fob will be recognized by the vehicle while switching the ignition on to start the vehicle.

Non-configurable Settings

The following settings cannot be changed by an admin key user:

- Belt-Minder or safety belt reminder. You cannot disable this feature. The audio system will mute when the front seat occupants' safety belts are not fastened.
- Early low fuel. The low-fuel warning activates earlier, giving the MyKey user more time to refuel.

- Driver assist features, if equipped on your vehicle, are forced on: rear parking aid, blind spot information system (BLIS) with cross traffic alert, lane departure warning and forward collision warning system.
- Track Mode, if your vehicle is equipped with this feature, is restricted.
- Satellite radio adult content restrictions (available only in some markets).

Note: You may be able to temporarily disable the lane departure warning feature. This feature is automatically enabled with every new key cycle.

Configurable Settings

With an admin key, you can configure certain MyKey settings when you first create a MyKey and before you recycle the key or restart the vehicle. You can also change the settings afterward with an admin key.

- A vehicle speed limit can be set. Warnings will be shown in the display followed by an audible tone when your vehicle reaches the set speed. You cannot override the set speed by fully depressing the accelerator pedal or by setting cruise control.

WARNING



Do not set MyKey maximum speed limit to a limit that will prevent the driver from maintaining a safe speed considering posted speed limits and prevailing road conditions. The driver is always responsible to drive in accordance with local laws and prevailing conditions. Failure to do so could result in accident or injury.

- Various vehicle speed minders can be set. Once you select a speed, it will be shown in the display, followed by an audible tone when the preselected vehicle speed is exceeded.
- Audio system maximum volume of 45%. A message will be shown in the display when you attempt to exceed the limited volume. Also, the speed-sensitive or compensated automatic volume control will be disabled.
- Always on setting. When this is selected, you will not be able to turn off traction control, Emergency Assistance and Do Not Disturb (if your vehicle is equipped with these features), and Sport Mode will not be available to MyKey drivers.

CREATING A MYKEY

Use the information display to create a MyKey:

1. Insert the key you want to program into the ignition. See **Starting a Gasoline Engine** (page 123). If your vehicle is equipped with a push-button start, place the remote control into the backup position. See **Passive Anti-Theft System** (page 62).
2. Switch the ignition on.
3. Access the main menu on the information display controls. Use the arrow keys to get to the following menu selections:

Message	Action and Description
Settings	Press the OK button or the right arrow key.
MyKey	Press the OK button or the right arrow key.
Create MyKey	Press the OK button or the right arrow key.

When prompted, hold the **OK** button until you see a message informing you to label this key as a MyKey. The key will be restricted at the next start.

MyKey is successfully created. Make sure you label it so you can distinguish it from the admin keys.

You can also program configurable settings for the key(s). See **Programming/Changing Configurable Settings**.

Programming/Changing Configurable Settings

Use the information display to access your configurable MyKey settings.

1. Switch the ignition on using an admin key or remote control.
2. Access the main menu on the information display controls. Use the arrow keys to get to the following menu selections:

Message	Action and Description
Settings	Press the OK button or the right arrow key.
MyKey	Press the OK button or the right arrow key.

Note: You can clear or change your MyKey settings at any time during the same key cycle as you created the MyKey. Once you have switched the vehicle off, however, you will need an admin key to change or clear your MyKey settings.

CLEARING ALL MYKEYS

You can clear or change your MyKey settings using the information display control on the steering wheel. See **Information Displays** (page 83).

Switch the ignition on using an admin key.

To clear all MyKeys of all MyKey settings, press the left arrow button to access the main menu and scroll to:

Message	Action and Description
Settings	Press the OK button or the right arrow button.
MyKey	Press the OK button or the right arrow button.
Clear MyKey	Press and hold the OK button until the instrument cluster displays the following message.
All MyKeys Cleared	

Note: When you clear your MyKeys, you remove all restrictions and return all MyKeys to their original admin key status.

CHECKING MYKEY SYSTEM STATUS

You can find information on programmed MyKey(s) using the information display control on the steering wheel. See **Information Displays** (page 83).

To find information on programmed MyKey(s), press the left arrow button to access the main menu and scroll to:

Message	Description
Settings	Press the OK button.
MyKey	Press the OK button.
Select one of the following:	
MyKey Dist.	Tracks the distance when drivers use a MyKey. The only way to delete the accumulated distance is by using an admin key to clear your MyKeys. If the distance does not accumulate as expected, then the intended user is not using the MyKey, or an admin key user recently cleared and then recreated a MyKey.
{0} MyKeys	Indicates the number of MyKeys programmed to your vehicle. Use this feature to detect how many MyKeys you have for your vehicle and determine when a MyKey has been deleted.
{0} Admin Keys	Indicates how many admin keys are programmed to your vehicle. Use this feature to determine how many unrestricted keys you have for your vehicle, and detect if an additional MyKey has been programmed.

USING MYKEY WITH REMOTE START SYSTEMS

MyKey is not compatible with non

Ford-approved, aftermarket remote start systems. If you choose to install a remote start system, see an authorized dealer for a Ford-approved remote start system.

MYKEY TROUBLESHOOTING

Condition	Potential Causes
I cannot create a MyKey.	<ul style="list-style-type: none"> • The key or transmitter used to start the vehicle does not have admin privileges. • The key or transmitter used to start the vehicle is the only admin key (there always has to be at least one admin key). • Vehicles with keyless start: The keyless start transmitter is not placed in the backup position. See Keyless Starting (page 122). • SecuriLock passive anti-theft system is disabled or in unlimited mode.
I cannot program the configurable settings.	<ul style="list-style-type: none"> • The key or transmitter used to start your vehicle does not have admin privileges. • No MyKeys are created. See Creating a MyKey (page 52).
I cannot clear the MyKeys.	<ul style="list-style-type: none"> • The key or transmitter used to start your vehicle does not have admin privileges. • No MyKeys are created. See Creating a MyKey (page 52).
I lost the only admin key.	Purchase a new key from an authorized dealer.
I lost a key.	Program a spare key. See Passive Anti-Theft System (page 62).
MyKey distances do not accumulate.	<ul style="list-style-type: none"> • The MyKey user is not using the MyKey. • An admin key holder cleared the MyKeys and created new MyKeys. • The key system has been reset.
No MyKey functions with the keyless entry transmitter.	<ul style="list-style-type: none"> • An admin transmitter is present at vehicle start. • No MyKeys are created. See Creating a MyKey (page 52).

Doors and Locks

LOCKING AND UNLOCKING

You can use the power door lock control or the remote control to lock and unlock your vehicle.

Power Door Locks

The power door lock control is on the driver and front passenger door panels.



E180791

- A Unlock.
- B Lock.

Door Lock Indicator

An LED on each door window trim lights when you lock the door. It remains lit for up to 10 minutes after you switch off the ignition.

Switch Inhibitor

When you electronically lock your vehicle, the power door lock button and interior luggage compartment release button, after 20 seconds, no longer operate. You must unlock your vehicle with the remote control, or switch on the ignition, to restore function to these buttons. You can switch this feature on or off in the information display. See **General Information** (page 83).

Remote Control

You can use the remote control at any time. The luggage compartment release button only works when your vehicle speed is less than 5 mph (8 km/h).

You can link your remote control to memory seat and mirror positions, if equipped. See **Memory Function** (page 112).

Unlocking the Doors (Two-Stage Unlock)



Press the button to unlock the driver door. Press the button again within three seconds to unlock all doors. The directional indicators flash.

Press and hold both the lock and unlock buttons on the remote control for three seconds to change between driver-door or all-door unlock mode. The direction indicators flash twice to indicate a change to the unlocking mode. Driver-door unlock mode only unlocks the driver door when you press the unlock button once. All-door unlock mode unlocks all doors with one press of the unlock button. The unlocking mode applies to the remote control and intelligent access. You can also change the mode in the information display. See **General Information** (page 83).

Locking the Doors



Press the button to lock all the doors. The direction indicators flash. Press the button again within three seconds to confirm that all the doors are closed. The doors lock again, the horn sounds and the direction indicators flash if all the doors and the luggage compartment are closed.

Doors and Locks

Mislock

If any door or the luggage compartment is open, or if the hood is open on vehicles with an anti-theft alarm or remote start, the horn sounds twice and the directional indicators do not flash. You can enable or disable this feature in the information display. See **General Information** (page 83).

Opening the Luggage Compartment



Press twice within three seconds to open the luggage compartment.

Make sure to close and latch the luggage compartment before driving your vehicle. Objects may fall from an unlatched luggage compartment. An unlatched luggage compartment may block your rear view.

Activating Intelligent Access

General Information

You can unlock and lock the vehicle without taking the keys out of your pocket or purse when your intelligent access key is within 3 ft (1 m) of your vehicle. Intelligent access uses a sensor on the back of the door handle for unlocking and a separate sensor on the face of each door handle for locking.

The system will not function if:

- Your vehicle battery has no charge.
- The key battery has no charge.
- The passive key frequencies are jammed.

Note: *The system may not function if the passive key is close to metal objects or electronic devices, for example keys or a cell phone.*

Note: *If the system does not function, use the key blade to lock and unlock your vehicle. See **Remote Control** (page 47).*

Unlocking Using Intelligent Access

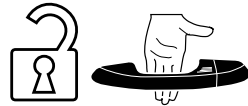

E248553

With your intelligent access key within 3 ft (1 m) of your vehicle, touch the unlock sensor on the back of the door handle for a brief period and then pull on the door handle to unlock, being careful to not touch the lock sensor at the same time or pulling the door handle too quickly. The intelligent access system requires a brief delay to authenticate your intelligent access key fob.

Locking Using Intelligent Access



E248554

With your intelligent access key within 3 ft (1 m) of your vehicle, touch the outer door handle lock sensor for approximately one second to lock, being careful to not touch the unlock sensor on the back of the door handle at the same time. After locking, you can immediately pull on the door handle to confirm locking occurred without inadvertently unlocking.

Doors and Locks

Opening the Luggage Compartment



E175208

Press the exterior release button hidden above the license plate.

Smart Unlocks

This feature helps to prevent you from unintentionally locking your intelligent access key inside your vehicle's passenger compartment or luggage compartment.

When you electronically lock your vehicle (with any door open, vehicle in park and ignition off), your vehicle searches for an intelligent access key in the passenger compartment after you close the last door. If your vehicle finds a key, all of the doors immediately unlock and the horn sounds twice, indicating that a key is inside.

You can override the smart unlock feature and intentionally lock the intelligent access key inside your vehicle. To do this, lock your vehicle after you have closed all the doors by:

- Pressing the lock button on another intelligent access key.
- Touching the locking area on the handle with another intelligent access key in your hand.

When you open one of the front doors and lock your vehicle using the power door lock control, all doors lock then unlock if:

- The ignition is on.
- The ignition is off and your vehicle is not in **P**.

Auto Relock

If you press the unlock button on the remote control and do not open a door within 45 seconds, your vehicle locks and arms your alarm. You can enable or disable this feature in the information display. See **General Information** (page 83).

Autolock Feature

The autolock feature locks all the doors when:

- All doors are closed.
- The ignition is on.
- You shift into any gear putting your vehicle in motion.
- And your vehicle attains a speed greater than 12 mph (20 km/h).

The autolock feature repeats when:

- You open, and then close, any door while the ignition is on and your vehicle speed is 9 mph (15 km/h).
- And your vehicle then attains a speed greater than 12 mph (20 km/h).

Enabling or Disabling

To enable or disable the autolock feature, contact an authorized dealer.

Doors and Locks

Autounlock Feature

The autounlock feature unlocks all the doors when:

- The ignition is on, all the doors are closed, and your vehicle has been in motion at a speed greater than 12 mph (20 km/h).
- The vehicle comes to a stop and you switch the ignition off or to accessory.
- And you open the driver door within 10 minutes of switching the ignition off or to accessory.

Note: *The doors do not autounlock if you electronically lock your vehicle after you switch the ignition off and before you open the driver door.*

Enabling or Disabling

You can enable or disable the autounlock feature in the information display or an authorized dealer can do it for you. See **General Information** (page 83).

Key Blade

Turn the top of the key toward the front of your vehicle once to lock all doors.

Turn the top of the key toward the rear of your vehicle once to unlock the driver door only. See **Remote Control** (page 47).

Locking the Doors Individually

If the power locks do not operate because of a discharged battery, lock the doors individually using the mechanical key blade in the position shown.



E180643

Left-Hand Side

Turn clockwise to lock.

Right-Hand Side

Turn counterclockwise to lock.

Doors and Locks

Unlocking the Luggage Compartment (Convertible Only)



E188353

If the power decklid release does not operate because of a discharged battery, pull the rear seat left-hand side seatback cushion aside, insert the mechanical key blade into the key slot and turn the key to release the decklid latch.

Illuminated Entry

The interior lamps and select exterior lamps illuminate when you unlock the doors with the remote entry system.

The illuminated entry system turns off the lights if:

- The ignition is on.
- You press the remote control lock button.
- After 25 seconds of illumination.

The lights do not turn off if:

- You switch them on with the lamp control.
- Any door is open.

Illuminated Exit

The interior lamps and select exterior lamps illuminate when all doors are closed and you switch the ignition off.

The lamps turn off if all the doors remain closed and:

- 25 seconds elapse.
- You press the **START/STOP** button.

Battery Saver

If you leave on the courtesy lamps, dome lamps or headlamps, the battery saver turns them off 10 minutes after you switch off the ignition.

Accessory Mode Battery Saver for Intelligent Access Keys

If you leave your vehicle in the run ignition state, it turns off once it detects a certain amount of battery drain or after 45 minutes.

Luggage Compartment

From Inside Your Vehicle



E188015

Press the button on the instrument panel to unlatch the luggage compartment.

With the Remote Control



Press twice within three seconds to unlatch the luggage compartment.

Doors and Locks

From Outside Your Vehicle



E175208

Press the release button above the license plate to unlatch the luggage compartment. Your vehicle must be unlocked or have an intelligent access transmitter within 3 ft (1 m) of the luggage compartment.

INTERIOR LUGGAGE COMPARTMENT RELEASE

WARNINGS



Keep vehicle doors and luggage compartment locked and keep keys and remote transmitters out of a child's reach. Unsupervised children could lock themselves in the trunk and risk injury. Children should be taught not to play in vehicles.



Do not leave children or animals unattended in the vehicle. On hot days, the temperature in the trunk or vehicle interior can rise very quickly. Exposure of people or animals to these high temperatures for even a short time can cause death or serious heat-related injuries, including brain damage. Small children are particularly at risk.

Your vehicle is equipped with a release handle that provides a means of escape for children and adults if they become locked inside the luggage compartment.

Adults should familiarize themselves with the operation and location of the release handle.

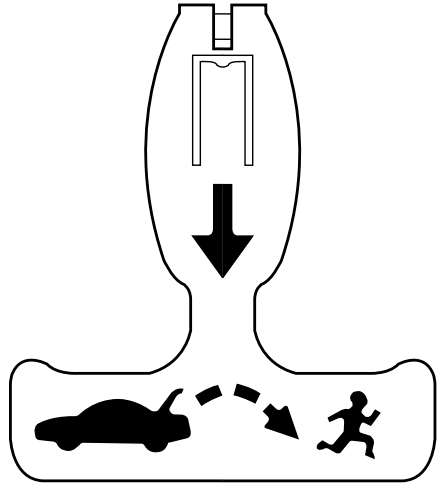

E144403

The handle is located inside the luggage compartment either on the luggage compartment door (lid) or near the tail lamps. It is composed of a material that will glow for hours in darkness following brief exposure to ambient light.

Pull the handle and push up on the luggage compartment door (lid) to open from within the luggage compartment.

Security

PASSIVE ANTI-THEFT SYSTEM

Note: *The system is not compatible with non-Ford aftermarket remote start systems. Use of these systems may result in vehicle starting problems and a loss of security protection.*

Note: *Metallic objects, electronic devices or a second coded key on the same key chain may cause vehicle starting problems if they are too close to the key when starting your vehicle. Prevent these objects from touching the coded key while starting your vehicle. Switch the ignition off, move all objects on the key chain away from the coded key and restart your vehicle if a problem occurs.*

Note: *Do not leave a duplicate coded key in your vehicle. Always take your keys and lock all doors when leaving your vehicle.*

SecuriLock

The system helps prevent your vehicle from starting unless you use a coded key programmed to your vehicle. Using the wrong key may prevent your vehicle from starting. A message may appear in the information display.

If you are unable to start your vehicle with a correctly coded key, it is not operating properly. A message may appear in the information display.

Automatic Arming

Your vehicle arms immediately after switching the ignition off.

Automatic Disarming

Switching the ignition on with a coded key disarms your vehicle.

Replacement Keys

Note: *Your vehicle comes equipped with two intelligent access keys.*

The intelligent access key functions as a programmed key that operates the driver door lock and activates the intelligent access with push button start system, as well as a remote control.

If your programmed transmitters are lost or stolen and you do not have an extra coded key, you need to have your vehicle towed to an authorized dealer. You need to erase the key codes from your vehicle and program new coded keys.

Store an extra programmed key away from your vehicle in a safe place to help prevent any inconveniences. See your authorized dealer to purchase additional spare or replacement keys.

Programming a Spare Intelligent Access Key

Note: *You can program a maximum of four intelligent access keys to your vehicle.*

You must have two previously programmed intelligent access keys inside your vehicle and the new unprogrammed intelligent access keys readily accessible. See an authorized dealer to have the spare key programmed if two previously programmed keys are not available.

Make sure that your vehicle is off before beginning this procedure. Make sure that you close all the doors before beginning and that they remain closed throughout the procedure. Perform all steps within 30 seconds of starting the sequence. Stop and wait for at least one minute before starting again if you perform any steps out of sequence.

Read and understand the entire procedure before you begin.

Security



E174956

1. Remove the rubber covering (A) from the cupholder. Place the first programmed key in the backup slot (B) at the bottom of the cupholder, then press the push button ignition switch.
2. Wait five seconds and then press the push button ignition switch again.
3. Remove the intelligent access key.
4. Within 10 seconds, place a second programmed intelligent access key in the backup slot. Press the push button ignition switch.
5. Wait five seconds and then press the push button ignition switch again.
6. Remove the intelligent access key.
7. Place the unprogrammed intelligent access key in the backup slot and press the push button ignition switch.

Programming is now complete. Verify the remote control functions operate and your vehicle starts with the new intelligent access key.

If programming was not successful, wait 10 seconds and repeat Steps 1 through 7. If you are still unsuccessful, take your vehicle to your authorized dealer.

ANTI-THEFT ALARM (If Equipped)

The system will warn you of an unauthorized entry to your vehicle. It will be triggered if any door, the luggage compartment or the hood is opened without using the key, remote control or keyless entry keypad.

The direction indicators will flash and the horn will sound if unauthorized entry is attempted while the alarm is armed.

Take all remote controls to an authorized dealer if there is any potential alarm problem with your vehicle.

Arming the Alarm

The alarm is ready to arm when there is not a key in your vehicle. Electronically lock your vehicle to arm the alarm.

Disarming the Alarm

Disarm the alarm by any of the following actions:

- Unlock the doors or luggage compartment with the remote control or keyless entry keypad.
- Switch your vehicle on or start your vehicle.
- Use a key in the driver door to unlock your vehicle, then switch your vehicle on within 12 seconds.

Note: *Pressing the panic button on the remote control will stop the horn and signal indicators, but will not disarm the system.*

Steering Wheel

ADJUSTING THE STEERING WHEEL

WARNING

 Do not adjust the steering wheel when your vehicle is moving.

Note: Make sure that you sit in the correct position. See **Sitting in the Correct Position** (page 109).



E176634

1. Unlock the steering column.
2. Adjust the steering wheel to the desired position.



E176635

3. Lock the steering column.

AUDIO CONTROL (If Equipped)

You can operate the following functions with the control:

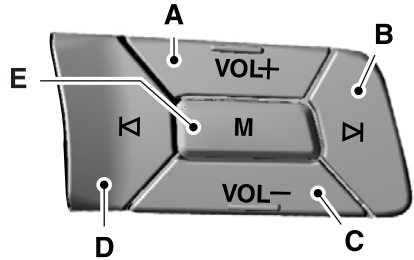

E174583

- A Volume up.
- B Seek up or next.
- C Volume down.
- D Seek down or previous.
- E Media.

MEDIA

Press repeatedly to scroll through available audio sources.

Seek, Next or Previous

Press the seek button to:

- Tune the radio to the next or previous stored preset.
- Play the next or the previous track.

Press and hold the seek button to:

- Tune the radio to the next station up or down the frequency band.
- Seek or fast forward through a track.

Steering Wheel

VOICE CONTROL (If Equipped)

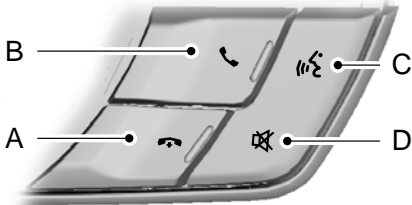

E174584

- A End a call.
- B Answer a call.
- C Voice recognition.
- D Mute.

See your SYNC information.

CRUISE CONTROL

Type 1

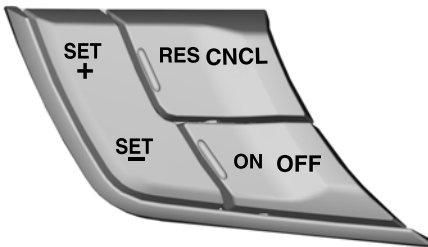

E174594

Type 2 (If Equipped)

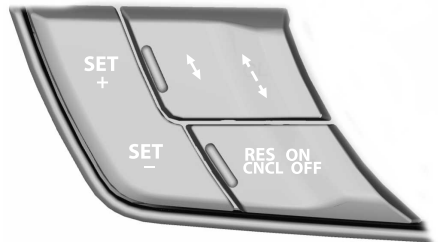

E177068

See **Cruise Control** (page 155).

INFORMATION DISPLAY CONTROL

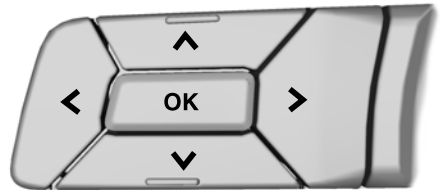

E174595

See **Information Displays** (page 83).

Wipers and Washers

WINDSHIELD WIPERS

Note: Fully defrost the windshield before you switch the windshield wipers on.

Note: Make sure you switch the windshield wipers off before entering a car wash.

Note: If streaks or smears appear on the windshield, clean the windshield and the wiper blades. If that does not resolve the issue, install new wiper blades.

Note: Do not operate the wipers on a dry windshield. This may scratch the glass, damage the wiper blades or cause the wiper motor to burn out. Always use the windshield washers before wiping a dry windshield.

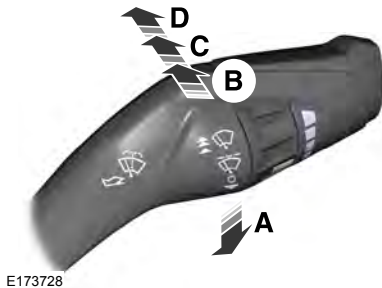

E173728

- A Single wipe.
- B Intermittent wipe.
- C Normal wipe.
- D High speed wipe.

Intermittent Wipe

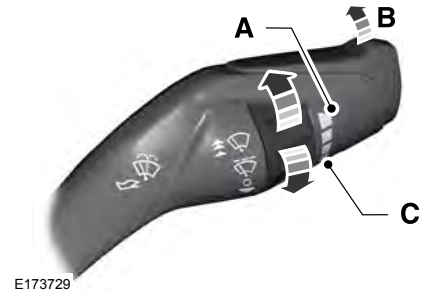

E173729

- A Shortest wipe interval.
- B Intermittent wipe.
- C Longest wipe interval.

Use the rotary control to adjust the intermittent wipe interval.

Speed Dependent Wipers

When your vehicle speed increases, the interval between wipes decreases.

AUTOWIPERS (If Equipped)

Note: Fully defrost the windshield before you switch the windshield wipers on.

Note: Make sure you switch the windshield wipers off before entering a car wash.

Note: If streaks or smears appear on the windshield, clean the windshield and the wiper blades. If that does not resolve the issue, install new wiper blades.

Note: If you switch autolamps and autowipers on, the headlamps automatically turn on when the windshield wipers continuously operate.

Wipers and Washers

Wet or winter driving conditions with ice, snow or salty road mist can cause inconsistent and unexpected wiping or smearing.

The feature uses a rain sensor that is in the area around the interior mirror. The rain sensor monitors the amount of moisture on the windshield and automatically turns on the wipers. It adjusts the wiper speed by the amount of moisture that the sensor detects on the windshield. You can switch this feature on and off in the information display.

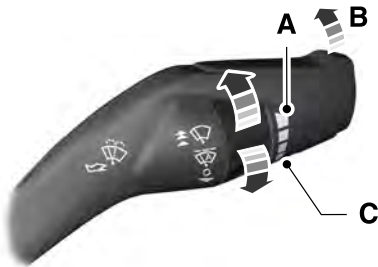

E173730

- A Highest sensitivity.
- B On.
- C Lowest sensitivity.

Use the rotary control to adjust the sensitivity of the autowipers. When you select low sensitivity, the wipers operate when the sensor detects a large amount of water on the windshield. When you select high sensitivity, the wipers operate when the sensor detects a small amount of water on the windshield.

Keep the outside of the windshield clean. The rain sensor is very sensitive and the wipers may operate if dirt, mist or insects hit the windshield.

In these conditions, you can do the following:

- Lower the sensitivity of the autowipers to reduce the amount of smearing on the windshield.
- Switch to normal or high-speed wipe.
- Switch autowipers off.

WINDSHIELD WASHERS

Note: Do not operate the washers when the washer reservoir is empty. This may cause the washer pump to overheat.



E173731

To operate the washers and spray the windshield, pull the lever toward you.

Lighting

GENERAL INFORMATION

Condensation in the Exterior Front Lamps and Rear Lamps

Exterior front lamps and rear lamps have vents to accommodate normal changes in air pressure.

Condensation can be a natural by-product of this design. When moist air enters the lamp assembly through the vents, there is a possibility that condensation can occur when the temperature is cold. When normal condensation occurs, a fine mist can form on the interior of the lens. The fine mist eventually clears and exits through the vents during normal operation.

Clearing time may take as long as 48 hours under dry weather conditions.

Examples of acceptable condensation are:

- The presence of a fine mist (no streaks, drip marks or large droplets).
- A fine mist covers less than 50% of the lens.

Examples of unacceptable condensation are:

- A water puddle inside the lamp.
- Streaks, drip marks or large droplets present on the interior of the lens.

If you see any unacceptable condensation, have your vehicle checked by an authorized dealer.

LIGHTING CONTROL



E142449

- A Off
- B Parking lamps, instrument panel lamps, license plate lamps and tail lamps
- C Headlamps

High Beams



E162679

Push the lever forward to switch the high beams on.

Push the lever forward again or pull the lever toward you to switch the high beams off.

Lighting

Headlamp Flasher



E162680

Pull the lever toward you slightly and release it to flash the headlamps.

AUTOLAMPS (If Equipped)

WARNING



The autolamps switch position may not activate the headlamps in all low visibility conditions, such as daytime fog. Always ensure that your headlamps are switched to auto or on, as appropriate, during all low visibility conditions. Failure to do so may result in a crash.



E142451

When the lighting control is in the autolamps position, the headlamps automatically turn on in low light situations or when the wipers turn on.

When the lighting control is in the autolamps position, you can switch on the following in the information display:

- Configurable daytime running lamps.
- Automatic high beam control.
- Adaptive headlamp control.

The headlamps remain on for a period of time after you switch the ignition off. Use the information display controls to adjust the period of time that the headlamps remain on.

Note: If you switch on the autolamps, you cannot switch the high beam headlamps on until the autolamps system turns the low beam headlamps on.

Windshield Wiper Activated Headlamps

Note: If you switch autolamps and autowipers on, the headlamps automatically turn on when the windshield wipers continuously operate.

When you switch the autolamps on, the windshield wiper activated headlamps turn on within 10 seconds of switching on the wipers. They turn off approximately 60 seconds after you switch the windshield wipers off.

The headlamps do not turn on with the wipers:

- During a single wipe.
- When you use the windshield washer.
- If the wipers are in intermittent mode.

INSTRUMENT LIGHTING DIMMER

Note: If you disconnect the battery or it becomes discharged, the illuminated components switch to the maximum setting.

Lighting

Vehicles With Front Fog Lamps



E132712

Press repeatedly or press and hold until you reach the desired level.

Vehicles Without Front Fog Lamps



E165366

- A Press repeatedly or press and hold to dim.
- B Press repeatedly or press and hold to brighten.

HEADLAMP EXIT DELAY

After you switch the ignition off, you can switch the headlamps on by pulling the direction indicator lever toward you. You will hear a short tone. The headlamps will switch off automatically after three minutes with any door open or 30 seconds after the last door has been closed. You can cancel this feature by pulling the direction indicator toward you again or switching the ignition on.

DAYTIME RUNNING LAMPS (If

Equipped)

WARNING

 The daytime running lamps system does not activate the rear lamps and may not provide adequate lighting during low visibility driving conditions. Also, the autolamps switch position may not activate the headlamps in all low visibility conditions, such as daytime fog. Make sure the headlamps are switched to auto or on, as appropriate, during all low visibility conditions. Failure to do so may result in a crash.

Type 1 - Conventional (Non-Configurable)

The daytime running lamps turn on when:

1. The ignition is switched to the on position.
2. The transmission is not in park (P) for vehicles with automatic transmissions or the parking brake is released for vehicles with manual transmissions.
3. The lighting control is in the off, parking lamp or autolamps positions.
4. The headlamps are off.

Lighting

Type 2 - Configurable

Switch the daytime running lamps on or off using the information display controls.

The daytime running lamps turn on when:

1. They are switched on in the information display.
2. The ignition is switched to the on position.
3. The transmission is not in park (P) for vehicles with automatic transmissions or the parking brake is released for vehicles with manual transmissions.
4. The lighting control is in the autolamps position.
5. The headlamps are off.

The other lighting control switch positions do not activate the daytime running lamps, and you can use them to temporarily override autolamp control.

When switched off in the information display, the daytime running lamps are off in all lighting control switch positions.

FRONT FOG LAMPS (If Equipped)



E142453

Press the control to switch the fog lamps on or off.

You can switch the fog lamps on when the lighting control is in any position except Off and the high beams are not on.

DIRECTION INDICATORS



E162681

Push the lever up or down to use the direction indicators.

Note: Tap the lever up or down to make the direction indicators flash three times to indicate a lane change.

WELCOME LIGHTING (If Equipped)

Pony Projection Lights

The pony projection lights are on the bottom of the exterior mirror housings. They project an image onto the ground a short distance from your vehicle when welcome lighting or lighted entry turns on.

Note: Moisture, frost and ice build-up or other types of contamination on the surface of the light lens can cause non-permanent distortion or reduced brightness of the image. Do not use abrasive materials to clean the lens.

Note: For vehicles with manual transmission, you may need to engage the parking brake for this feature to operate.

Lighting

INTERIOR LAMPS

The lamps turn on under the following conditions:

- You open any door.
- You press a remote control button.
- You press a map lamp button.

Map Lamps



E175199

- A Left-hand side map lamp.
- B Right-hand side map lamp.

Press the button to switch the lamps on or off.

AMBIENT LIGHTING (If Equipped)

Adjust the ambient lighting system in the information display. See **Information Displays** (page 83).

Windows and Mirrors

POWER WINDOWS

WARNINGS



Do not leave children unattended in your vehicle and do not let them play with the power windows. They may seriously injure themselves.



When closing the power windows, you should verify they are free of obstructions and make sure that children and pets are not in the proximity of the window openings.



E180087

Note: You may hear a pulsing noise when just one of the windows is open. Lower the opposite window slightly to reduce this noise.

Note: Use the singular control (if equipped) to open both rear windows.

Press the control to open the window.

Lift the control to close the window.

One-Touch Down

Press the control fully and release it. Press again or lift it to stop the window.

One-Touch Up

Lift the control fully and release it. Press again or lift it to stop the window.

Bounce-Back

The window will automatically stop and reverse some distance if it detects an obstacle while closing.

Overriding the Bounce-Back Feature

WARNING



When you override the bounce-back feature the window will not reverse if it detects an obstacle. Take care when closing the windows to avoid personal injury or damage to your vehicle.

Pull up the window switch and hold within two seconds of the window reaching the bounce-back position. The window will travel up with no bounce-back protection. The window will stop if you release the switch before the window is fully closed.

Accessory Delay

The window switches remain operational for several minutes when you switch the ignition off or until you open either front door.

GLOBAL OPENING (If Equipped)

You can use the remote control to operate the windows with the ignition off.

Note: You can enable or disable this feature in the information display, or see an authorized dealer. See **General Information** (page 83).

Note: To operate this feature, accessory delay must not be active.

Windows and Mirrors

Opening the Windows

You can open the windows for a short time after you unlock your vehicle with the remote control. After you unlock your vehicle, press and hold the remote control unlock button to open the windows. Release the button once movement starts. Press the lock or unlock button to stop movement.

EXTERIOR MIRRORS

Power Exterior Mirrors

WARNING



Do not adjust the mirrors when your vehicle is moving.

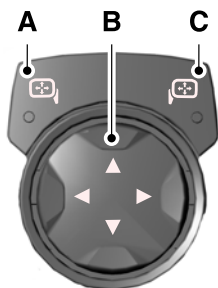

E176804

- A Left-hand mirror
- B Adjustment control
- C Right-hand mirror

To adjust a mirror:

1. Select the mirror you want to adjust. The control will illuminate.
2. Adjust the position of the mirror.
3. Press the mirror switch again.

Fold-Away Exterior Mirrors

Push the mirror toward the door window glass. Make sure that you fully engage the mirror in its support when returning it to its original position.

Heated Exterior Mirrors (If Equipped)

See **Heated Windows and Mirrors** (page 107).

Memory Mirrors (If Equipped)

You can save and recall the mirror positions through the memory function. See **Power Seats** (page 111).

Signal Indicator Mirrors (If Equipped)

The outer portion of the appropriate mirror housing will blink when you switch on the turn signal.

Pony Projection Lights (If Equipped)

The lights are on the bottom of the mirror housings.

This feature projects an image onto the ground a short distance from the vehicle with the illuminated entry and exit feature.

Note: *Moisture, frost and ice build-up (or other types of contamination) on the surface of the light lens can cause some non-permanent distortion or reduced brightness of the image. Do not use abrasive materials to clean the lens.*

Integrated Blind Spot Mirrors (If Equipped)

WARNING



Objects in the blind spot mirror are closer than they appear.

Windows and Mirrors

Blind spot mirrors have an integrated convex mirror built into the upper outboard corner of the exterior mirrors. They can increase your visibility along the side of your vehicle.

Check the main mirror first before a lane change, then check the blind spot mirror. If the blind spot mirror does not show any vehicles in its viewing area and the traffic in the adjacent lane is at a safe distance, signal that you intend to change lanes. Glance over your shoulder to verify traffic is clear and carefully change lanes.

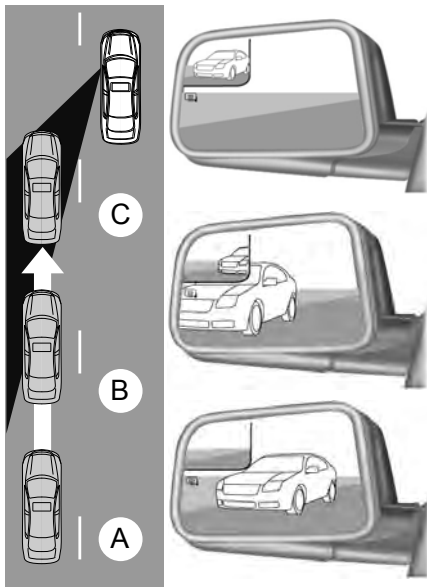

E138665

The image of the approaching vehicle is small and near the inboard edge of the main mirror when it is at a distance. The image becomes larger and begins to move outboard across the main mirror as the vehicle approaches (A). The image will transition from the main mirror and begin to appear in the blind spot mirror as the vehicle approaches (B). The vehicle will transition to your peripheral field of view as it leaves the blind spot mirror (C).

Blind Spot Monitor (if Equipped)

See **Blind Spot Information System** (page 162).

INTERIOR MIRROR

WARNING



Do not adjust the mirror when your vehicle is moving.

Note: Do not clean the housing or glass of any mirror with harsh abrasives, fuel or other petroleum or ammonia-based cleaning products.

You can adjust the interior mirror to your preference. In addition to the standard pivot point, this mirror also includes a second pivot point, letting you move the mirror head up or down and from side to side.

Auto-Dimming Mirror

Note: Do not block the sensors on the front and back of the mirror. Mirror performance may be affected. A rear center passenger or raised rear center head restraint may also block light from reaching the sensor.

Windows and Mirrors

To reduce glare, the mirror dims automatically when it detects bright lights from behind your vehicle. It automatically returns to normal reflection when you select reverse (R) gear to make sure you have a clear view when backing up.

SUN VISORS

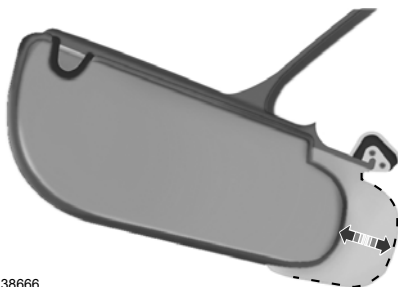

E138666

Rotate the sun visor toward the side window and extend it rearward for extra shade.

Illuminated Vanity Mirror

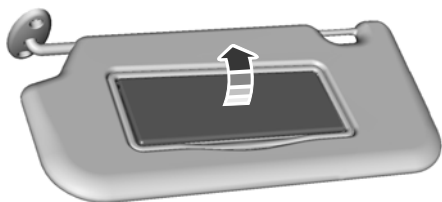

E162197

Lift the cover to switch the lamp on.

Instrument Cluster

GAUGES

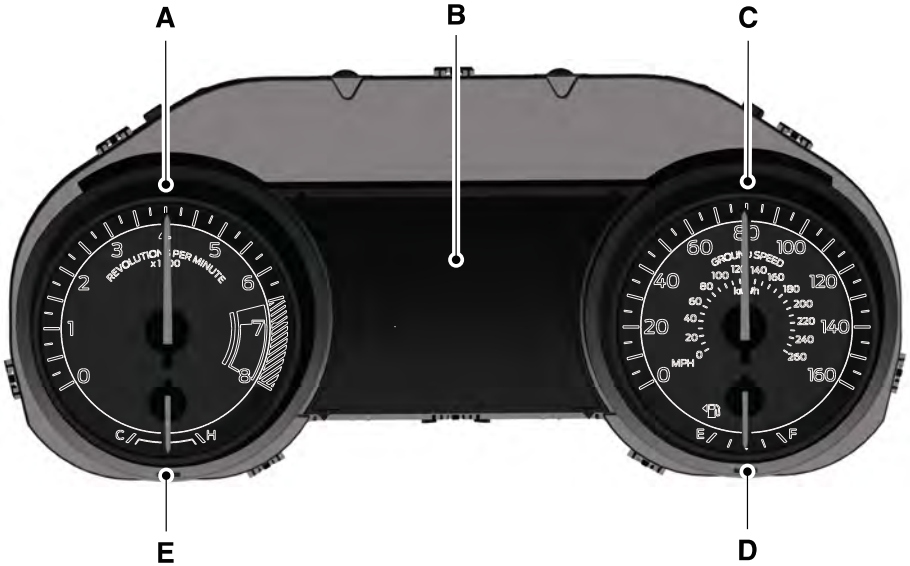

E174486

- A Tachometer (Revolutions per minute)
- B Information display
- C Speedometer (Ground speed)
- D Fuel gauge
- E Engine coolant temperature gauge

Information Display

Odometer

Located in the bottom of the information display. Registers the accumulated distance your vehicle has traveled.

Trip Computer

See **General Information** (page 83).

Vehicle Settings and Personalization

See **General Information** (page 83).

Instrument Cluster

Fuel Gauge

Note: *The fuel gauge may vary slightly when your vehicle is moving or on a gradient.*

Switch the ignition on. The fuel gauge will indicate approximately how much fuel is left in the fuel tank. The arrow adjacent to the fuel pump symbol indicates on which side of your vehicle the fuel filler door is located.

The needle should move toward F when you refuel your vehicle. If the needle points to E after adding fuel, this indicates your vehicle needs service soon.

After refueling some variability in needle position is normal:

- It may take a short time for the needle to reach F after leaving the gas station. This is normal and depends upon the slope of pavement at the gas station.
- The fuel amount dispensed into the tank is a little less or more than the gauge indicated. This is normal and depends upon the slope of pavement at the gas station.
- If the gas station nozzle shuts off before the tank is full, try a different gas pump nozzle.

Low Fuel Reminder

A low fuel reminder triggers when the distance to empty value reaches 50 mi (80 km) to empty, with additional warnings at 25 mi (40 km), 10 mi (20 km) and 0 mi (0 km) to empty, provided the message is cleared each time. An additional warning at 75 mi (120 km) to empty is provided when the MyKey is being used.

Variations:

Note: *The low fuel warning and distance-to-empty warning can appear at different fuel gauge positions depending on fuel economy conditions. This variation is normal.*

Driving type (fuel economy conditions)	Distance-to-empty	Fuel gauge position
Highway driving	50 mi (80 km)	1/8th tank
Severe duty driving (trailer towing, extended idle)	50 mi (80 km)	1/4 tank

Engine Coolant Temperature Gauge

WARNING



Never remove the coolant reservoir cap while the engine is running or hot.

Indicates engine coolant temperature. At normal operating temperature, the level indicator will be in the normal range. If the engine coolant temperature exceeds the normal range, stop your vehicle as soon as safely possible, switch off the engine and let it cool.

Instrument Cluster

Gauge Package (If Equipped)



E196366

Oil Pressure Gauge

Indicates the engine oil pressure.

Vacuum/Boost Gauge

Indicates the vacuum and boost pressure in the intake.

WARNING LAMPS AND INDICATORS

The following warning lamps and indicators will alert you to a vehicle condition that may become serious. Some lamps will illuminate when you start your vehicle to make sure they work. If any lamps remain on after starting your vehicle, refer to the respective system warning lamp for further information.

Note: Some warning indicators appear in the information display and function the same as a warning lamp but do not display when you start your vehicle.

Adaptive Cruise Control (If Equipped)



The speed control system indicator light changes color to indicate what mode the system is in: See **Using Adaptive Cruise Control** (page 156).

On (white light): Illuminates when the adaptive cruise control system is turned on. Turns off when the speed control system is turned off.

Engaged (green light): Illuminates when the adaptive cruise control system is engaged. Turns off when the speed control system is disengaged.

Anti-Lock Braking System



If it illuminates when you are driving, this indicates a malfunction. You will continue to have the normal braking system (without ABS) unless the brake system warning lamp is also illuminated. Have the system checked by your authorized dealer.

Battery



If it illuminates while driving, it indicates a malfunction. Switch off all unnecessary electrical equipment and have the system checked by your authorized dealer immediately.

Blind Spot Monitor (If Equipped)



It will illuminate when you switch this feature off or in conjunction with a message. See **Blind Spot Information System** (page 162). See **Information Messages** (page 91).

Brake System



It will illuminate when you engage the parking brake with the ignition on.

If it illuminates when you are driving, check that the parking brake is not engaged. If the parking brake is not engaged, this indicates low brake fluid level or a brake system malfunction. Have the system checked immediately by your authorized dealer.

Instrument Cluster

WARNING



Driving your vehicle with the warning lamp on is dangerous. A significant decrease in braking performance may occur. It will take you longer to stop your vehicle. Have your vehicle checked by your authorized dealer immediately. Driving extended distances with the parking brake engaged can cause brake failure and the risk of personal injury.

Cruise Control (If Equipped)



It will illuminate when you switch this feature on.

Direction Indicator



Illuminates when the left or right turn signal or the hazard warning flasher is turned on. If the indicators stay on or flash faster, check for a burned out bulb. See **Changing a Bulb** (page 226).

Door Ajar



Displays when the ignition is on and any door is not completely closed.

Engine Coolant Temperature



Illuminates when the engine coolant temperature is high. Stop the vehicle as soon as possible, switch off the engine and let cool. See **Engine Coolant Check** (page 216).

Engine Oil



If it illuminates with the engine running or when you are driving, this indicates a malfunction. Stop your vehicle as soon as it is safe to do so and switch the engine off. Check the engine oil level. See **Engine Oil Check** (page 215).

Note: Do not resume your journey if it illuminates despite the level being correct. Have the system checked by your authorized dealer immediately.

Fasten Safety Belt



It will illuminate and a chime will sound to remind you to fasten your safety belt. See **Seatbelt Reminder** (page 33).

Front Airbag



If it fails to illuminate when you start your vehicle, continues to flash or remains on, it indicates a malfunction. Have the system checked by your authorized dealer.

Front Fog Lamps (If Equipped)



Lights when you switch the front fog lamps on.

Heads Up Display (If Equipped)



A red beam of lights will illuminate on the windshield in certain instances when using adaptive cruise control or the collision warning system. It will also illuminate momentarily when you start your vehicle to make sure the display works.

Instrument Cluster

High Beam



It will illuminate when you switch the high beam headlamps on. It will flash when you use the headlamp flasher.

Low Fuel Level



It will illuminate when the fuel level is low or the fuel tank is nearly empty. Refuel as soon as possible.

Low Tire Pressure Warning



It will illuminate when your tire pressure is low. If the lamp remains on with the engine running or when driving, check your tire pressures as soon as possible.

It will also illuminate momentarily when you switch the ignition on to confirm the lamp is functional. If it does not illuminate when you switch the ignition on, or begins to flash at any time, have the system checked by your authorized dealer.

Parking Lamps



It will illuminate when you switch the parking lamps on.

Service Engine Soon



If the service engine soon indicator light stays illuminated after the engine is started, it indicates that the On Board Diagnostics system (OBD) has detected a malfunction of the vehicle emissions control system. Refer to On board diagnostics (OBD) in the Fuel and Refueling chapter for more information about having your vehicle serviced. See **Emission Control System** (page 133).

If the light is blinking, engine misfire is occurring which could damage your catalytic converter. Drive in a moderate fashion (avoid heavy acceleration and deceleration) and have your vehicle serviced immediately.

WARNING



Under engine misfire conditions, excessive exhaust temperatures could damage the catalytic converter, the fuel system, interior floor coverings or other vehicle components, possibly causing a fire. Have an authorized dealer service your vehicle immediately.

The service engine soon indicator light illuminates when the ignition is first turned on prior to engine start to check the bulb and to indicate whether the vehicle is ready for Inspection/Maintenance (I/M) testing.

Normally, the service engine soon light will stay on until the engine is cranked, then turn itself off if no malfunctions are present. However, if after 15 seconds the service engine soon light blinks eight times, it means that the vehicle is not ready for I/M testing. See **Emission Control System** (page 133).

Stability Control



It will flash when the system is active. If it remains illuminated or does not illuminate when you switch the ignition on, this indicates a malfunction. During a malfunction the system will switch off. Have the system checked by your authorized dealer immediately. See **Using Stability Control** (page 147).

Instrument Cluster

Stability Control Off



It will illuminate when you switch the system off. It will go out when you switch the system back on or when you switch the ignition off. See **Using Stability Control** (page 147).

AUDIBLE WARNINGS AND INDICATORS

Keyless Warning Alert

The horn will sound twice when you exit your vehicle with the intelligent access key and your vehicle is in ON, indicating your vehicle is still on. The horn will also sound twice when you exit your vehicle and attempt to lock the doors manually while the intelligent access key is still in the vehicle. The doors will not lock if the intelligent access key remains in the vehicle.

Headlamps On Warning Chime

Sounds when you remove the key from the vehicle and you have left the headlamps or parking lamps on.

Parking Brake On Warning Chime

(If Equipped)

Sounds when you have left the parking brake on and drive your vehicle. If the warning chime remains on after you have released the parking brake, have the system checked by your authorized dealer immediately.

Information Displays

GENERAL INFORMATION

WARNING



Driving while distracted can result in loss of vehicle control, crash and injury. We strongly recommend that you use extreme caution when using any device that may take your focus off the road. Your primary responsibility is the safe operation of your vehicle. We recommend against the use of any handheld device while driving and encourage the use of voice-operated systems when possible. Make sure you are aware of all applicable local laws that may affect the use of electronic devices while driving.

Various systems on your vehicle can be controlled using the information display controls on the steering wheel. Corresponding information is displayed in the information display.

Information Display Controls



E174488

- Press the up and down arrow buttons to scroll through and highlight the options within a menu.
- Press the right arrow button to enter a sub-menu.
- Press the left arrow button to exit a menu.
- Press and hold the left arrow button at any time to return to the main menu display (escape button).
- Press the **OK** button to choose and confirm settings or messages.

Information Displays

Main Menu

Gauge Mode
Trip/Fuel
Track Apps™
Driver Assist
Settings



This icon gives you the ability to switch a feature on or off. A check in the box indicates the feature is enabled, and unchecked indicates the feature is disabled.

Note: Some options may appear slightly different or not at all if the items are optional.

Gauge Mode		
Distance to Empty		
Tire Pressure		
Gauge Detail	Air/Fuel Ratio	Virtual gauge shown
	Boost/Vacuum	
	Cylinder Head Temp	
	Inlet Air Temp	
	Oil Pressure	
	Oil Temp	Virtual gauge shown
	Trans Oil Temp	
	Voltage	

Note: In order to provide real-time values, some gauges may display more value fluctuation than other gauges during normal operation.

Some gauges shown in standard measure. Metric similar.

Air/Fuel Ratio

Displays the current air to fuel mixture in the engine.

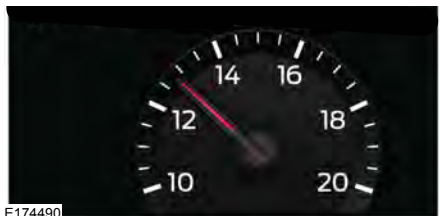

E174490

Information Displays

Boost/Vacuum

Displays the vacuum or boost pressure.



E213874

Inlet Air Temp

Displays the temperature of the air in the cold air inlet tube.



Oil Temp

Displays the engine oil temperature. If the temperature rises to the red area, stop in a safe place and let your vehicle cool. If the problem persists, see an authorized dealer.

Cylinder Head Temp

Displays the engine's cylinder head temperature.



Information Displays

Trans Oil Temp

Displays the transmission fluid operating temperature. If the temperature rises to the red area, stop in a safe place and let the transmission cool. If the problem persists, see an authorized dealer.



E174494

Voltage

Displays your vehicle's battery voltage. If the voltage is consistently too high or very low, contact an authorized dealer.



E174495

Trip/Fuel

Trip 1 or Trip 2 - Trip timer, Trip distance, mi to E and avg mpg

Fuel Economy

Instant fuel economy

AVG MPG

mi to E

Fuel History

Last 30 minutes

AVG MPG

mi to E

Average Speed

Note: Press and hold **OK** to reset the currently displayed information.

Menu Item	Description
Trip Timer	Registers the time of individual journeys.
Trip Distance	Registers the mileage of individual journeys.
Mi to E	Shows the approximate distance our vehicle can travel before running out of fuel.

Information Displays

Menu Item	Description
Avg MPG	Shows the average fuel usage based on time.
Instant fuel economy	Shows your instantaneous fuel usage.
Fuel History	Shows fuel usage as a bar graph based on time. The graph is updated each minute with the fuel economy that you achieved during 30 minutes of driving.

WARNING



Track Apps is for track use only. Remember that even advanced technology cannot defy the laws of physics. It is always possible to lose control of a vehicle due to inappropriate driver input for the conditions. Aggressive driving on any road condition can cause you to lose control of your vehicle increasing the risk of personal injury or property damage.

Note: *Track Apps are for track use only. They are not to be used under any other driving conditions.*

Note: *Viewed or cleared results cannot be used unless your vehicle is at a complete stop. The right arrow on the display menu will be inactive. If your vehicle does not reach 100 mph (160 km/h) during the track run, your display may not display your 1/4 mile results.*

Note: *The system will disable the collision warning system while using track apps or when you switch off advancetrac.*

Track Apps	
Accelerometer	Virtual gauge shown
Acceleration Timer	Select your speed, distance and start settings
Brake Performance	Select setting
Lap Timer	Track (XXX)
Launch Control	Launch Control
	RPM
Line Lock	
View/Clear Results	Acceleration Timer
	Brake Performance

Information Displays

Track Apps	
	All Time Best
	Clear Saved Data
	Clear All Time Best

Accelerometer
Displays your vehicle's rate of acceleration or deceleration.



Displays your vehicle's rate of acceleration or deceleration.

The red dot will move toward the area of acceleration or deceleration.

- LEFT acceleration or deceleration - When accelerating or decelerating left, the red dot will move to the right on the accelerometer.
- RIGHT acceleration/deceleration - When accelerating or decelerating right, the red dot will move to the left on the accelerometer.

Acceleration Timer
Displays your vehicle's rate of acceleration.

1. Choose desired speed or distance.

2. Choose Automatic Start or Countdown Start.
3. Follow the on-screen prompts.

Brake Performance
Displays your vehicle's rate of deceleration.

1. Choose desired speed to start recording data.
2. Follow the on-screen prompts.

Lap Timer
Gives the driver the ability to record lap times at three separate tracks.

Launch Control
Maximize traction from a standing start.

Line Lock
Locks front brakes while allowing rear wheels to turn freely.

View/Clear Results
View and clear the last and saved results of the acceleration timer, brake performance and all time best.

Note: Some items are optional and may not appear.

Information Displays

Driver Assist		
AdvanceTrac		
Auto Engine Off		
Blindspot		
Collision Warning	On	
	Sensitivity	Select setting
Cross Traffic Alert		
Cruise Control	Select setting	
Hill Start Assist		
Rear Park Aid		
Seatbelts	On Demand screen pops up	

Note: Some items are optional and may not appear.

Settings			
Vehicle	Easy Entry/Exit		
	Lighting	Autolamp Delay	Select setting
		Daytime Lights	
	Locks	Autounlock	
		Mislock	
		Relock	
		Remote Unlock	Select setting
		Switch Inhibit	
	Oil Life Reset		
	Park Lock Control		
	Remote Start	Climate Control	Select setting

Information Displays

Settings				
		Seats		
		Duration		
		System		
	Tire Mobility Kit	Select setting		
	Windows	Remote Open		
		Remote Close		
	Wipers	Courtesy Wipe		
Rain Sensing				
MyColor	Gauge Color	Select color		
	Ambient Light	Ambient Light		
		Ambient Dim	Select setting	
		Ambient Color	Select color	
Set MyColor	Set MyColor 1 - 3			
MyKey	MyKey Status	Select setting		
	Create MyKey			
	911 Assist			
	AdvanceTrac			
	Do Not Disturb			
	Max Speed			
	Speed Minder			
	Volume Limiter			
	Clear MyKeys	Select setting		

Information Displays

Settings		
Display Setup	Distance	Select setting
	Temperature	
	Tire Pressure	
	Language	

INFORMATION MESSAGES

Note: Depending on your vehicle options and instrument cluster type, not all of the messages display or are available. The information display may abbreviate or shorten certain messages.

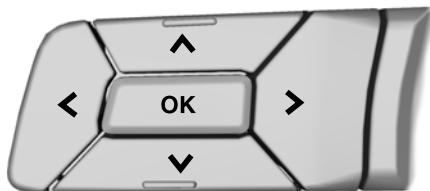

E174595

Press the **OK** button to acknowledge and remove some messages from the information display. The information display automatically removes other messages after a short time.

You need to confirm certain messages before you can access the menus.

Adaptive Cruise Control

Message	Action
Adaptive Cruise Malfunction	A radar malfunction is preventing the adaptive cruise control from engaging. See Using Adaptive Cruise Control (page 156).
Adaptive Cruise Not Available	A condition exists such that the adaptive cruise cannot function properly. See Using Adaptive Cruise Control (page 156).
Adaptive Cruise Not Available Sensor Blocked See Manual	You have a blocked sensor due to bad weather, ice, mud or water in front of the radar sensor. You can typically clean the sensor to resolve. See Using Adaptive Cruise Control (page 156).

Information Displays

Message	Action
Normal Cruise Active Automatic Braking Turned Off	The system has disabled the automatic braking.
Front Sensor Not Aligned	A radar malfunction is preventing the adaptive cruise control from engaging.
Adaptive Cruise - Driver Resume Control	The adaptive cruise has reinstated controls to the driver.
Adaptive Cruise Speed Too Low to Activate	Your vehicle speed is too slow to activate the adaptive cruise.
Adaptive Cruise Shift Down	The adaptive cruise is automatically adjusting the gap distance and the driver needs to shift the transmission into a lower gear.

AdvanceTrac™

Message	Action
Service AdvanceTrac	The system detects a malfunction due to a blocked sensor.
AdvanceTrac Off On	The driver has disabled or enabled the traction control.
AdvanceTrac SPORT MODE	The system is in sport mode.

Airbag

Message	Action
Occupant Sensor BLOCKED Remove Objects Near Passenger Seat	The system detects a malfunction due to a blocked sensor. Remove blockage.

Information Displays

Alarm

Message	Action
Vehicle Alarm To Stop Alarm, Start Vehicle.	Alarm triggered due to unauthorized entry. See Anti-Theft Alarm (page 63).
Alarm All Sensors Perimeter Sensing	All perimeter sensors are active. See Anti-Theft Alarm (page 63).

Battery and Charging System

Message	Action
Check Charging System	The charging system needs servicing. If the warning stays on or continues to come on, contact an authorized dealer as soon as possible.
Charging System Service Soon	The charging system needs servicing. If the warning stays on or continues to come on, contact an authorized dealer as soon as possible.
Charging System Service Now	The charging system needs servicing. Contact an authorized dealer as soon as possible.
Battery State of Charge Low	The battery management system determines that the battery is at a low state of charge. Turn your ignition off as soon as possible to protect the battery. This message clears once you restart your vehicle and the battery state of charge has recovered.
Low Battery Features Temporarily Turned Off	The battery management system detects an extended low-voltage condition. Your vehicle disables various features to help preserve the battery. Turn off as many of the electrical loads as soon as possible to improve system voltage. If the system voltage has recovered, the disabled features operate again as normal.
Turn Power Off To Save Battery	The battery management system determines that the battery is at a low state of charge. Turn your ignition off as soon as possible to protect the battery. This message clears once you restart your vehicle and the battery state of charge has recovered. Turning off unnecessary electrical loads allow faster battery state-of-charge recovery.

Information Displays

Blind Spot Information and Cross Traffic Alert System

Message	Action
Blindspot System Fault	A fault with the system has occurred. Contact an authorized dealer as soon as possible.
Blindspot Not Available Sensor Blocked See Manual	The system sensors are blocked.
Cross Traffic Not Available Sensor Blocked See Manual	The blind spot information system and cross traffic alert system sensors are blocked.
Cross Traffic System Fault	A fault with the system has occurred. Contact an authorized dealer as soon as possible.

Collision Warning System

Message	Action
Collision Warning Malfunction	A fault with the system has occurred. Contact an authorized dealer as soon as possible.
Collision Warning Not Available Sensor Blocked See Manual	You have a blocked sensor due to bad weather, ice, mud or water in front of the radar sensor. You can typically clean the sensor to resolve.
Collision Warning Not Available	A fault with the system has occurred. Contact an authorized dealer as soon as possible.

Doors and Locks

Message	Action
X Door Ajar	The door(s) listed is not completely closed.
Trunk Ajar	The trunk is not completely closed.
Hood Ajar	The hood is not completely closed.
Switches Inhibited Security Mode	The system has disabled the door switches.

Information Displays

Engine

Message	Action
Power Reduced to Lower Engine Temp	The engine is overheating and the power has been reduced to assist in lowering the temperature. Stop in a safe place as soon as it is possible.

Fuel

Message	Action
Fuel Level Low	An early reminder of a low fuel condition.
Check Fuel Fill Inlet	The fuel fill inlet may not be properly closed.

Hill Start Assist

Message	Action
Hill Start Assist Not Available	Hill start assist is not available. Contact an authorized dealer. See Hill Start Assist (page 143).

Keys and Intelligent Access

Message	Action
To START Press Brake	A reminder to press the brake while starting the vehicle.
To START Press Clutch	A reminder to depress the clutch pedal on manual transmission while starting the vehicle.
No Key Detected	The system does not detect a key in your vehicle. See Keyless Starting (page 122).
Restart Now or Key is Needed	You pressed the start/stop button to switch off the engine and your vehicle does not detect your intelligent access key inside your vehicle.
Accessory Power is Active	Your vehicle is in the accessory ignition state.
Starting System Fault	There is a problem with your vehicle's starting system. See an authorized dealer for service.

Information Displays

Message	Action
Key Program Successful	You have successfully programmed an intelligent access key to the system.
Key Program Failure	You have failed to program an intelligent access key to the system.
Max Number of Keys Learned	You have programmed the maximum number of keys to the system.
Not Enough Keys Learned	You have not programmed enough keys to the system.
Key Battery Low Replace Soon	The key battery is low. Change the battery as soon as possible.
Engine ON	Inform the driver that they are exiting the vehicle and the engine is on.

Maintenance

Message	Action
Low Engine Oil Pressure	Stop your vehicle as soon as safely possible and turn off the engine. Check the oil level. If the warning stays on or continues to come on with your engine running, contact an authorized dealer as soon as possible.
Change Engine Oil Soon	The engine oil life remaining is 10% or less. See Engine Oil Check (page 215).
Oil Change Required	The oil life left is at 0%. See Engine Oil Check (page 215).
Brake Fluid Level Low	The brake fluid level is low, inspected the brake system immediately. See Brake Fluid Check (page 221).
Check Brake System	The brake system needs servicing. Stop your vehicle in a safe place. Contact an authorized dealer.
Transport / Factory Mode	Your vehicle is still in Transport or Factory mode. This may not allow some features to operate properly. See an authorized dealer.
See Manual	The powertrain needs service due to a powertrain malfunction.

Information Displays

MyKey

Message	Action
MyKey not Created	You cannot program a MyKey.
MyKey Active Drive Safely	MyKey is active.
Speed Limited to XX MPH/km/h	When switching on your vehicle and MyKey is in use, displays that the MyKey speed limit is on.
Near Vehicle Top Speed	MyKey is in use and the MyKey speed limit is on and the vehicle speed is approaching 80 mph (130 km/h).
Vehicle at Top Speed of MyKey Setting	You have reached the speed limit set for your MyKey.
Check Speed Drive Safely	You have an active MyKey with a programmed set speed limit.
Buckle Up to Unmute Audio	Belt-Minder turns on with a MyKey in use.
AdvanceTrac On - MyKey Setting	With a MyKey in use, AdvanceTrac turns on.
Traction Control On - MyKey Setting	With a MyKey in use, traction control turns on.
MyKey Park Aid Cannot be Deactivated	With a MyKey in use, park aid is always on.

Park Aid

Message	Action
Check Rear Park Aid	The system has detected a condition that requires service. Contact an authorized dealer. See Rear Parking Aid (page 150).
Rear Park Aid On Off	Displays the park aid status.

Information Displays

Park Brake

Message	Action
Park Brake Engaged	You have set the parking brake and you have driven the vehicle more than 3 mph (5 km/h). If the warning stays on after you have released the parking brake, contact an authorized dealer.

Rear Axle

Message	Action
Axle Over Temperature Reduce Speed	This message appears when the oil temperature in the rear differential exceeds a safe limit. Reduce speed to allow the oil temperature to return to normal levels.

Remote Start

Message	Action
To Drive: Press Brake and Start Button	A reminder to apply the brake and push the start button to drive your vehicle after a remote start.

Seats

Message	Action
Memory Recall Not Permitted While Driving	A reminder that memory seats are not available while driving.
Memory {0} Saved	Shows where you have saved your memory setting.

Information Displays

Starting System

Message	Action
To START Press Brake	A reminder to apply the brake when starting your vehicle.
To START Press Clutch	A reminder to apply the clutch when starting your vehicle.
Cranking Time Exceeded	The starter has exceeded its cranking time in attempting to start your vehicle.
Engine Start Pending Please Wait	The starter is attempting to start your vehicle.
Pending Start Cancelled	The system has cancelled the pending start.

Steering System

Message	Action
Steering Fault Service Now	The power steering system has detected a condition that requires service. See an authorized dealer.
Steering Loss Stop Safely	The power steering system is not working. Stop your vehicle in a safe place. Contact an authorized dealer.
Steering Assist Fault Service Required	The power steering system has detected a condition within the power steering system or passive entry or passive start system requires service. Contact an authorized dealer.
Steering Lock Malfunction Service Now	The steering lock system has detected a condition that requires service. See an authorized dealer.
Steering Column Lock Remove and re-insert key while turning wheel to unlock	You need to turn your steering wheel while start your vehicle to unlock your steering column.

Tire Mobility Kit

Message	Action
Service Tire Mobility Kit	This message appears when the tire sealing compound in the Temporary Mobility Kit expires and you need to replace it.

Information Displays

Tire Pressure Monitoring System

Message	Action
Tire Pressure Low	One or more tires on your vehicle has low tire pressure. See Tire Pressure Monitoring System (page 260).
Tire Pressure Monitor Fault	The tire pressure monitoring system is malfunctioning. If the warning stays on or continues to come on, contact an authorized dealer. See Tire Pressure Monitoring System (page 260).
Tire Pressure Sensor Fault	A tire pressure sensor is malfunctioning or your spare tire is in use. See Tire Pressure Monitoring System (page 260). If the warning stays on or continues to come on, contact an authorized dealer as soon as possible.

Traction Control

Message	Action
Traction Control Off / Traction Control On	The status of the traction control system after you switched it off or on. See Using Traction Control (page 145).
Spinout Detected Hazards Activated	A spinout has occurred and the hazards are on.

Transmission

Message	Action
Transmission Malfunction Service Now	See your authorized dealer.
Transmission Overheating Stop Safely	The transmission is overheating and needs to cool. Stop in a safe place as soon as it is possible.
Transmission Over Temperature Stop Safely	The transmission has overheated and needs to cool. Stop in a safe place as soon as it is possible.
Transmission Service Required	See your authorized dealer.
Transmission Too Hot Press Brake	Transmission is getting hot. Stop to let it cool.

Information Displays

Message	Action
Transmission Limited Function See Manual	Displays when the transmission has overheated and has limited functionality. See Automatic Transmission (page 138).
Transmission Warming Up Please Wait	Transmission is too cold. Wait for it to warm up before you drive.
Transmission Not in Park	Displays as a reminder to shift into park.
Press Brake Pedal	Displays as a reminder to press the brake pedal in order to select a gear.
Transmission Adjusted	Displays when the transmission has adjusted the shift strategy.
Transmission Adapt-Mode	Displays when the transmission is adjusting the shift strategy.
Transmission Indicat-Mode Lockup On	Displays when the transmission shift lever is locked and unable to select gears.
Transmission Indicat-Mode Lockup Off	Displays when the transmission shift lever is unlocked and free to select gears.

Climate Control

MANUAL CLIMATE CONTROL (If Equipped)

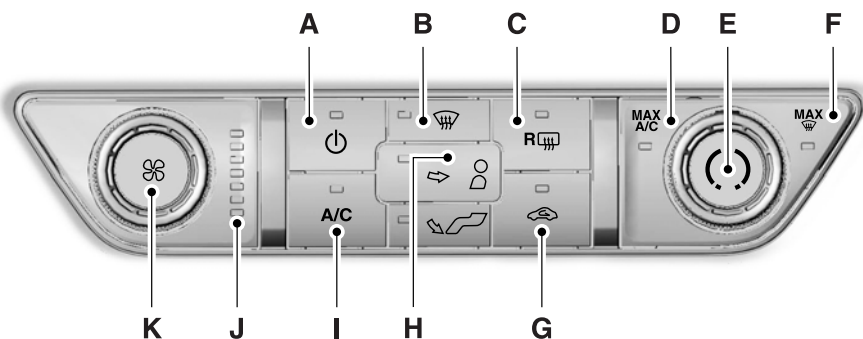

E174095

- A **Power:** Press to switch the system on and off. When the system is off, it prevents outside air from entering the vehicle.
- B **Defrost:** Press to distribute air through the windshield air vents and de-mister. Air distribution to the instrument panel and footwell vents turns off. You can also use this setting to defrost and clear the windshield of a thin covering of ice.
- C **Heated rear window:** Press to switch the heated rear window on and off. See **Heated Windows and Mirrors** (page 107).
- D **MAX A/C:** Press for maximum cooling. Recirculated air flows through the instrument panel vents and air conditioning automatically turns on.
- E **Temperature control:** Adjusts the temperature of the air circulated in your vehicle.
- F **MAX Defrost:** Press to switch on defrost. Outside air flows through the windshield vents. You can also use this setting to defrost and clear the windshield of a thin covering of ice.
Note: To prevent window fogging, you cannot select recirculated air when maximum defrost is on.
- G **Recirculated air:** Press to switch between outside air and recirculated air. The air currently in the passenger compartment recirculates. This may reduce the time needed to cool the interior (when used with A/C) and reduce unwanted odors from entering your vehicle.

Climate Control

Note: Recirculated air may turn on and off automatically (or prevent you from switching on) in all modes except MAX A/C to reduce the risk of fogging or to improve cooling efficiency.

H **Air distribution control:** Press to switch airflow from the windshield, instrument panel and footwell vents on or off. You can distribute air through any combination of these vents.

I **A/C:** Press to switch the air conditioning on or off. Air conditioning cools your vehicle using outside air. Use A/C with recirculated air to improve performance and efficiency.

Note: In certain conditions (for example, maximum defrost), the air conditioning compressor may continue to operate even though you switch off the air conditioning.

J **Fan speed indicator:** Illuminates to indicate fan speed.

K **Fan speed control:** Adjusts the volume of air circulated in the vehicle.

AUTOMATIC CLIMATE CONTROL (If Equipped)

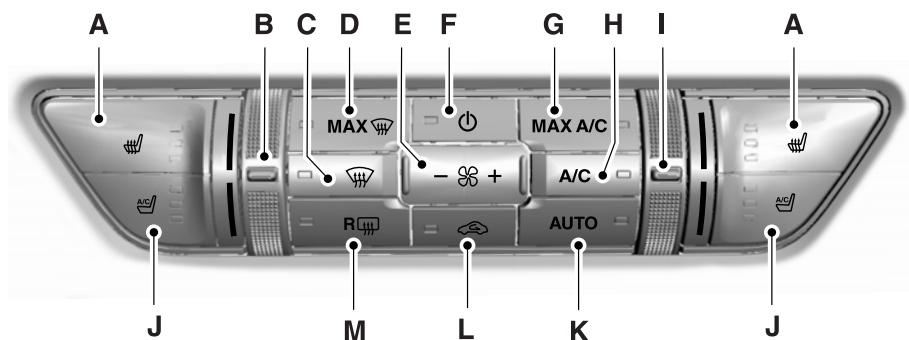

E174096

A **Heated seats:** Press to switch the heated seats on and off. See **Climate Controlled Seats** (page 114).

B **Left-hand temperature control:** Adjusts the temperature setting on the left-hand side. This control also adjusts the right-hand side temperature when you switch off dual zone mode.

Climate Control

- C **Defrost:** Press to distribute air through the windshield air vents and de-mister. Air distribution to the instrument panel and footwell vents turns off. You can also use this setting to defrost and clear the windshield of a thin covering of ice.
- D **MAX Defrost:** Press to switch on defrost. The driver and passenger settings set to HI, outside air flows through the windshield vents, and fan automatically adjusts to the highest speed. You can also use this setting to defrost and clear the windshield of a thin covering of ice. The heated rear window also automatically turns on when you select maximum defrost.
Note: To prevent window fogging, you cannot select recirculated air when maximum defrost is on.
- E **Fan speed control:** Adjusts the volume of air circulated in the vehicle.
- F **Power:** Press to switch the system on and off. When the system is off, it prevents outside air from entering the vehicle.
- G **MAX A/C:** Press for maximum cooling. The driver and passenger settings set to LO, recirculated air flows through the instrument panel vents, air conditioning automatically turns on and the fan automatically adjusts to the highest speed.
- H **A/C:** Press to switch the air conditioning on or off. Air conditioning cools your vehicle using outside air. Use A/C with recirculated air to improve performance and efficiency.
Note: In certain conditions (for example, maximum defrost), the air conditioning compressor may continue to operate even though you switch off the air conditioning.
- I **Right-hand temperature control:** Adjusts the temperature setting on the right-hand side.
- J **Climate controlled seats:** Press to switch the climate controlled seats on and off. See **Climate Controlled Seats** (page 114).
- K **AUTO:** Press to switch on automatic operation. Adjust to select the desired temperature. Fan speed, air distribution, air conditioning operation, and outside or recirculated air automatically adjust to heat or cool the vehicle to maintain the desired temperature. You can also switch off dual zone mode by pressing and holding for more than two seconds.
- L **Recirculated air:** Press to switch between outside air and recirculated air. The air currently in the passenger compartment recirculates. This may reduce the time needed to cool the interior (when used with A/C) and reduce unwanted odors from entering your vehicle.
Note: Recirculated air may turn on and off automatically (or prevent you from switching on) in all modes except MAX A/C to reduce the risk of fogging or to improve cooling efficiency.
- M **Heated rear window:** Press to switch the heated rear window on and off. See **Heated Windows and Mirrors** (page 107).

Climate Control

HINTS ON CONTROLLING THE INTERIOR CLIMATE

General Hints

WARNING



Prolonged use of recirculated air may cause the windows to fog up. If the windows fog up, follow the settings for demisting the windshield.

Note: You may feel a small amount of air from the footwell air vents regardless of the air distribution setting.

Note: To reduce humidity build-up inside your vehicle, do not drive with the system switched off or with recirculated air always switched on.

Note: Do not place objects under the front seats as this may interfere with the airflow to the rear seats.

Note: Remove any snow, ice or leaves from the air intake area at the base of the windshield.

Note: To improve the time to reach a comfortable temperature in hot weather, drive with the windows open until you feel cold air through the air vents.

Quickly Heating the Interior

	Vehicle with manual climate control	Vehicle with automatic climate control
1	Adjust the fan speed to the highest setting.	Press AUTO .
2	Adjust the temperature control to the full heat setting.	Adjust the temperature control to the desired setting.
3	Direct air to the footwell using the air distribution buttons.	

Manual Climate Control

Note: To reduce fogging of the windshield during humid weather, adjust the air distribution control to the windshield air vents position.

Automatic Climate Control

Note: Adjusting the settings when your vehicle interior is extremely hot or cold is not necessary. The system automatically adjusts to heat or cool the interior to your selected temperature as quickly as possible. For the system to function efficiently, the instrument panel and side air vents should be fully open.

Note: If you select **AUTO** during cold temperatures, the system directs airflow to the windshield and side window vents. In addition, the fan may run at a slower speed until the engine warms up.

Note: If you select **AUTO** during hot temperatures, or the inside of the vehicle is hot, the system automatically uses recirculated air to maximize interior cooling. When the interior reaches the selected temperature, the system automatically switches to using outside air.

Climate Control

Recommended Settings for Heating

	Vehicle with manual climate control	Vehicle with automatic climate control
1	Adjust the fan speed to the center setting.	Press AUTO .
2	Adjust the temperature control to the midway point of the hot settings.	Adjust the temperature control to the desired setting. Use 72°F (22°C) as a starting point, then adjust the setting as necessary.
3	Direct air to the footwell using the air distribution buttons.	

Quickly Cooling the Interior

	Vehicle with manual climate control	Vehicle with automatic climate control
1	Press MAX A/C .	Press MAX A/C .
2	Drive with the windows open until you feel cold air through the air vents.	

Recommended Settings for Cooling

	Vehicle with manual climate control	Vehicle with automatic climate control
1	Adjust the fan speed to the center setting.	Press AUTO .
2	Adjust the temperature control to the midway point of the cold settings.	Adjust the temperature control to the desired setting. Use 72°F (22°C) as a starting point, then adjust the setting as necessary.
3	Direct air to the instrument panel using the air distribution buttons.	

Climate Control

Defogging the Side Windows in Cold Weather

	Vehicle with manual climate control	Vehicle with automatic climate control
1	Direct air to the windshield using the air distribution buttons.	Press the defrost button.
2	Press A/C .	Adjust the temperature control to the desired setting. Use 72°F (22°C) as a starting point, then adjust the setting as necessary.
3	Adjust the temperature control to the desired setting.	
4	Adjust the fan speed to the highest setting.	

HEATED WINDOWS AND MIRRORS (If Equipped)

Heated Rear Window

Note: Make sure the engine is running before operating the heated windows.



Press the button to clear the heated rear window of thin ice and fog. The heated rear window will automatically turn off after a short period of time. Start the engine before you switch the heated rear window on.

Note: Do not use razor blades or other sharp objects to clean or remove decals from the inside of the heated rear window. The vehicle warranty does not cover damage caused to the heated rear window grid lines.

Heated Exterior Mirror (If Equipped)

When you switch the heated rear window on, the heated exterior mirrors will automatically turn on.

Note: Do not remove ice from the mirrors with a scraper or adjust the mirror glass when it is frozen in place.

Note: Do not clean the mirror housing or glass with harsh abrasives, fuel or other petroleum-based cleaning products.

CABIN AIR FILTER

Your vehicle is equipped with a cabin air filter, which gives you and your passengers the following benefits:

- It improves your driving comfort by reducing particle concentration.
- It improves the interior compartment cleanliness.
- It protects the climate control components from particle deposits.

You can locate the cabin air filter behind the glove box.

Note: Make sure you have a cabin air filter installed at all times. This prevents foreign objects from entering the system. Running the system without a filter in place could result in degradation or damage to the system.

Replace the filter at regular intervals. See **Scheduled Maintenance** (page 422).

Climate Control

For additional cabin air filter information, or to replace the filter, see an authorized dealer.

REMOTE START (If Equipped)

You can switch this feature on or off and adjust the settings using the information display.

The system adjusts the interior temperature depending on your chosen settings during remote start.

You cannot adjust the climate control setting during remote start operation. When you switch the ignition on, the climate control system returns to the previous settings. You can now make adjustments.

You need to switch on certain vehicle-dependent features, such as:

- Heated seats.
- Cooled seats.
- Heated steering wheel.
- Heated mirrors.
- Heated rear window.

Automatic Settings

In hot weather, the system is set to 72°F (22°C). The cooled seats are set to high (if available, and selected to **AUTO** in the information display).

In moderate weather, the system either heats or cools (based on previous settings). The rear defroster, heated mirrors and heated or cooled seats do not automatically turn on.

In cold weather, the system is set to 72°F (22°C). The heated seats are set to high (if available, and selected to **AUTO** in the information display). The heated rear window and heated mirrors automatically turn on.

Seats

SITTING IN THE CORRECT POSITION

WARNINGS

 Sitting improperly, out of position or with the seatback reclined too far can take weight off the seat cushion and affect the decision of the passenger sensing system, resulting in serious injury or death in the event of a crash. Always sit upright against your seat back, with your feet on the floor.

 Do not recline the seatback as this can cause the occupant to slide under the safety belt, resulting in serious injury in the event of a crash.

 Do not place objects higher than the seatback to reduce the risk of serious injury in the event of a crash or during heavy braking.

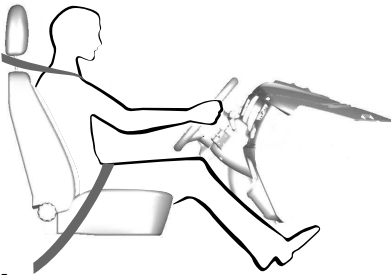

E68595

When you use them properly, the seat, head restraint, safety belt and airbags will provide optimum protection in the event of a crash.

We recommend that you follow these guidelines:

- Sit in an upright position with the base of your spine as far back as possible.
- Do not recline the seatback more than 30 degrees.
- Adjust the head restraint so that the top of it is level with the top of your head and as far forward as possible. Make sure that you remain comfortable.
- Keep sufficient distance between yourself and the steering wheel. We recommend a minimum of 10 in (25 cm) between your breastbone and the airbag cover.
- Hold the steering wheel with your arms slightly bent.
- Bend your legs slightly so that you can press the pedals fully.
- Position the shoulder strap of the safety belt over the center of your shoulder and position the lap strap tightly across your hips.

Make sure that your driving position is comfortable and that you can maintain full control of your vehicle.

HEAD RESTRAINTS

WARNINGS

 Fully adjust the head restraint before you operate your vehicle. This will help minimize the risk of neck injury in the event of a crash. Do not adjust the head restraint when your vehicle is moving.

 The adjustable head restraint is a safety device. Whenever possible it should be installed and properly adjusted when the seat is occupied. Failure to adjust the head restraint properly could reduce its effectiveness during certain impacts.

Seats

WARNINGS



Install the head restraint properly to help minimize the risk of neck injury in the event of a crash.

Note: Adjust the seatback to an upright driving position before adjusting the head restraint. Adjust the head restraint so that the top of it is level with the top of your head and as far forward as possible. Make sure that you remain comfortable. If you are extremely tall, adjust the head restraint to its highest position.

Front seat head restraints (if equipped)

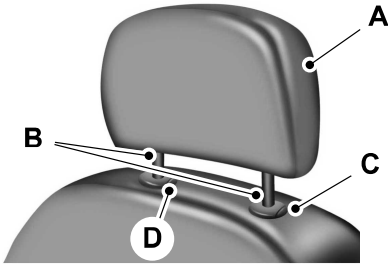

E138642

The head restraints consist of:

- A An energy absorbing head restraint.
- B Two steel stems.
- C Guide sleeve adjust and release button.
- D Guide sleeve unlock and remove button.

Adjusting the Head Restraint

Raising the Head Restraint

Pull the head restraint up.

Lowering the Head Restraint

1. Press and hold button C.
2. Push the head restraint down.

Removing the Head Restraint

1. Pull the head restraint up until it reaches its highest position.
2. Press and hold buttons C and D.
3. Pull the head restraint up.

Installing the Head Restraint

Align the steel stems into the guide sleeves and push the head restraint down until in locks.

Front Seat Non-Adjustable Head Restraints (If Equipped)



E174407

The non-adjustable head restraints consist of a trimmed foam covering over the upper structure of the seatback.

Properly adjust the seatback to an upright driving or riding position, so that the head restraint is positioned as close as possible to the back of your head.

Tilting Head Restraints (If Equipped)

The front head restraints tilt for extra comfort. To tilt the head restraint, do the following:

Seats



E144727

1. Adjust the seatback to an upright driving or riding position.
2. Pivot the head restraint forward toward your head to the desired position.

After the head restraint reaches the forward-most tilt position, pivoting it forward again will then release it to the rearward, un-tilted position.

MANUAL SEATS (If Equipped)

WARNINGS



Do not adjust the driver's seat or seatback when your vehicle is moving.



Rock the seat backward and forward after releasing the lever to make sure that it is fully engaged.



Reclining the seatback can cause an occupant to slide under the seat's safety belt, resulting in severe personal injuries in the event of a crash.

The manual front seats may consist of:



E174553

- A A bar to move the seat backward and forward.
- B A lever to adjust the height of the seat.
- C A lever to adjust the angle of the seatback.

POWER SEATS (If Equipped)

WARNINGS



Do not adjust the driver seat or seatback when your vehicle is moving.



Do not place cargo or any objects behind the seatback before returning it to the original position.

Seats

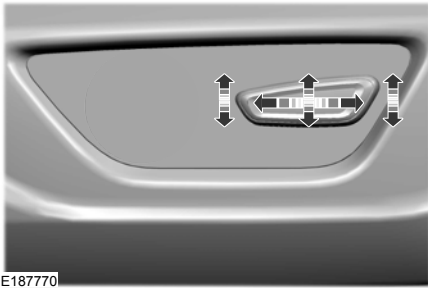

The power seat control is located on the outboard side of the seat. Move the control in the direction of the arrows to raise or lower the seat cushion or to move the seat forward, backward, up or down.

Power Lumbar (If Equipped)

The power lumbar control is located on the side of the driver seat.

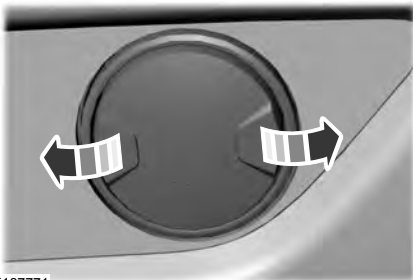

Press one side of the control to increase lower back firmness. Press the other side of the control to decrease lower back firmness.

MEMORY FUNCTION (If Equipped)

WARNINGS

 Before activating the seat memory, make sure that the area immediately surrounding the seat is clear of obstructions and that all occupants are clear of moving parts.

 Do not use the memory function when your vehicle is moving.

This feature will automatically recall the position of the driver seat and power mirrors. The memory control is located on the driver door.



Saving a PreSet Position

1. Switch the ignition on.
2. Adjust the seat and exterior mirrors to your desired position.
3. Press and hold the desired preset button until you hear a single tone.

You can save up to three preset memory positions. You can save a memory preset at any time.

Recalling a PreSet Position

Press and release the preset button associated with your desired driving position. The seat and mirrors will move to the position stored for that preset.

Seats

Note: A preset memory position can only be recalled when the ignition is off, or when the transmission is in park (P) or neutral (N) if the ignition is on.

You can also recall a preset memory position by:

- Pressing the unlock button on your intelligent access key fob if it is linked to a preset position.
- Unlocking the intelligent driver door handle if a linked key fob is present.
- Entering a personal entry code on the SecuriCode keypad. See **Doors and Locks** (page 56).

Note: Using a linked key fob to recall your memory position when the ignition is off will move the seat to the Easy Entry position.

Note: Pressing any seat or mirror adjustment control (or any memory button) during a memory recall cancels the operation.

Seat recall movement will also stop if you drive your vehicle.

Linking a PreSet Position to your Remote Control or Intelligent Access Key Fob

Your vehicle can save the preset memory positions for up to three remote controls or intelligent access (IA) keys.

1. With the ignition on, move the memory positions to the desired positions.
2. Press and hold the desired preset button for about five seconds. A tone will sound after about two seconds. Continue holding until a second tone is heard.
3. Within three seconds, press the lock button on the remote control you are linking.

To unlink a remote control, follow the same procedure – except in step 3, press the unlock button on the remote control.

Note: If more than one linked remote control or intelligent access key is in range, the memory function will move to the settings of the first key stored.

Easy Entry and Exit Feature

If you enable the easy entry and exit feature, it automatically moves the driver seat position rearward up to two inches (five centimeters) when you switch the ignition off.

The driver seat will return to the previous position when you switch the ignition on.

You can enable or disable this feature in the information display. See **Information Displays** (page 83).

REAR SEATS

WARNINGS



When folding the seat backrest down, take care not to get your fingers caught in the mechanism.



Make sure that the seats and the seat backrests are secure and fully locked in their catches.

Accessing the Rear Seats



E207088

Seats

Use the seatback release to fold the back of the front seat forward for rear seat access. The release handle is on the upper back of the front seat. The seatback has memory and locks automatically in the original position.

Second Row Split-Folding Rear Seat (If Equipped)

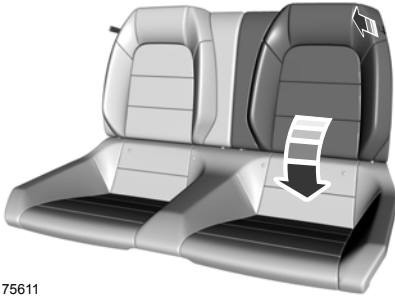

E175611

To lower the seatback(s):

1. Pull the strap to release the seatback.
2. Fold the seatback down.

Returning the Seatbacks to the Upright Position

When raising the seatback(s), push the top of the seatback rearward and make sure you hear the seat latch into place. Pull down on the seatback to make sure that it has locked into position.

CLIMATE CONTROLLED SEATS

(If Equipped)

Heated Seats

WARNING



Persons who are unable to feel pain to the skin because of advanced age, chronic illness, diabetes, spinal cord injury, medication, alcohol use, exhaustion, or other physical conditions, must exercise care when using the seat heater. The seat heater may cause burns even at low temperatures, especially if used for long periods of time. Do not place anything on the seat that insulates against heat, such as a blanket or cushion, because this may cause the seat heater to overheat.

Note: Do not do the following:

- Place heavy objects on the seat.
- Operate the seat heater if water or any other liquid is spilled on the seat. Allow the seat to dry thoroughly.
- Operate the heated seats unless the engine is running. Doing so can cause the battery to lose charge.



E146322

Touch the heated seat symbol to cycle through the various heat settings and off. Warmer settings are indicated by more indicator lights.

Cooled Seats (If Equipped)

The cooled seats will only function when the engine is running.

Seats



E146309

To operate the cooled seats:

Press the cooled seat symbol to cycle through the various cooling settings and off. Cooler settings are indicated by more indicator lights.

If the engine falls below 350 RPM while the cooled seats are on, the feature will turn itself off. You will need to reactivate it.

Universal Garage Door Opener (If Equipped)

HomeLink Wireless Control System

WARNINGS



Make sure that the garage door and security device are free from obstruction when you are programming. Do not program the system with the vehicle in the garage.



Do not use the system with any garage door opener that does not have the safety stop and reverse feature as required by U.S. Federal Safety Standards (this includes any garage door opener manufactured before April 1, 1982). A garage door opener which cannot detect an object, signaling the door to stop and reverse, does not meet current federal safety standards. Using a garage door opener without these features increases the risk of serious injury or death.

Note: Make sure you keep the original remote control transmitter for use in other vehicles as well as for future system programming.

Note: We recommend that upon the sale or lease termination of your vehicle, you erase the programmed function buttons for security reasons. See **Erasing the Function Button Codes** later in this section.

Note: You can program a maximum of three devices. To change or replace any of the three devices after it has been initially programmed, you must first erase the current settings. See **Erasing the Function Button Codes**.



E188211

The universal garage door opener replaces the common hand-held garage door opener with a three-button transmitter integrated into the driver's sun visor.

The system includes two primary features, a garage door opener and a platform for remote activation of devices within the home. You can program garage doors as well as entry gate operators, security systems, entry door locks and home or office lighting.

Additional system information can be found online at www.homelink.com, www.youtube.com/user/HomeLinkGentex or by calling the toll-free help line at 1-800-355-3515.

In-Vehicle Programming

This process is to program your in-vehicle HomeLink function button with your hand-held transmitter.

Note: The programming steps below assume you will be programming HomeLink that was not previously programmed. If your HomeLink was previously programmed, you may need to erase your HomeLink buttons. See **Erasing the Function Button Codes**.

Note: Put a new battery in the hand-held transmitter. This helps ensure quicker training and accurate transmission of the radio-frequency signal.

Universal Garage Door Opener (If Equipped)



E188212

1. With your vehicle parked outside of the garage, switch your ignition to the **on** position, but do not start your vehicle.
2. Press and release the function button that you would like to program.
3. Hold your hand-held garage door transmitter 1–3 in (2–8 cm) away from the HomeLink button you want to program.
4. Press and hold the hand-held transmitter button you want to program while watching the indicator light on HomeLink. Continue to hold the hand-held button until the HomeLink indicator light flashes rapidly or is continuously on.

Note: You may need to use a different method if you live in Canada or have difficulties programming your gate operator or garage door opener. See **Gate Operator / Canadian Programming**.

5. Press and hold the HomeLink button you programmed for two seconds, then release. You may need to do this twice to activate the door. If your garage door does not operate, watch the HomeLink indicator light.

If the indicator light stays on, the programming is complete. Your device should activate when the HomeLink button is pressed and released.

If the indicator light flashes rapidly, press and hold for two seconds and release the programmed HomeLink button. Repeat the "press/hold/release" sequence up to three times to complete the programming process. If your device still does not operate, you must program your garage door. See **Programming Your Garage Door Opener Motor**.

To program additional buttons, repeat Steps 1 – 4.

For questions or comments, please contact HomeLink at www.homelink.com, www.youtube.com/user/HomeLinkGentex or by calling the toll-free help line at 1-800-355-3515.

Programming Your Garage Door Opener Motor

Note: You may need a ladder to reach the unit and you may need to remove the cover or lamp lens on your garage door opener.



E142659

1. Press the learn button on the garage door opener motor and then you have 30 seconds to complete the next two steps.
2. Return to your vehicle.

Universal Garage Door Opener (If Equipped)

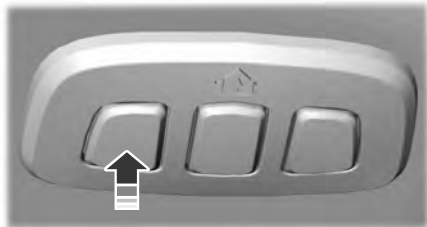

E188212

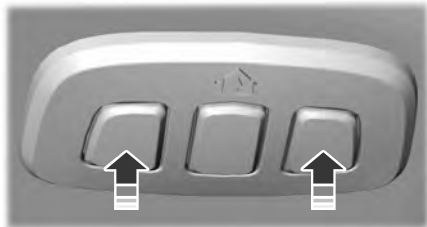

E188213

3. Press and hold the function button you want to program for 2 seconds, then release. Repeat this step. Depending on your brand of garage door opener, you may need to repeat this sequence a third time.

Gate Operator / Canadian Programming

Canadian radio-frequency laws require transmitter signals to “time-out” (or quit) after several seconds of transmission – which may not be long enough for HomeLink to pick up the signal during programming. Similar to this Canadian law, some U.S. gate operators are designed to “time-out” in the same manner.

Note: *If programming a garage door opener or gate operator, it is advised to unplug the device during the “cycling” process to prevent possible overheating.*

1. Press and release, **every two seconds**, your hand-held transmitter until the HomeLink indicator light changes to a rapidly blinking or continuously on light.
2. Release the hand-held transmitter button.
3. Continue programming HomeLink. See **In-Vehicle Programming, Step 4.**

Erasing the Function Button Codes

Note: *You cannot erase individual buttons.*

1. Press and hold the outer two function buttons simultaneously for approximately 10 seconds until the indicator light above the buttons flashes rapidly.
2. When the indicator light flashes, release the buttons. You erased the codes for all buttons.

Reprogramming a Single Button

To program a device to a previously trained button, follow these steps:

1. Press and hold the desired button. Do NOT release the button.
2. The indicator light begins to flash after 20 seconds. Without releasing the button, follow Step 1 in the Programming section.

For questions or comments, contact HomeLink at www.homelink.com, www.youtube.com/user/HomeLinkGentex or by calling the toll-free help line at 1-800-355-3515.

Universal Garage Door Opener (If Equipped)

FCC and RSS-210 Industry Canada Compliance

This device complies with Part 15 of the FCC Rules and with RSS-210 of Industry Canada. Operation is subject to the following two conditions: (1) this device may not cause harmful interference, and (2) this device must accept any interference received, including interference that may cause undesired operation.

Note: *Changes or modifications to your device not expressly approved by the party responsible for compliance can void the user's authority to operate the equipment.*

This equipment complies with FCC radiation exposure limits set forth for an uncontrolled environment. End Users must follow the specific operating instructions for satisfying RF exposure compliance. This transmitter must be at least 8 in (20 cm) from the user and must not be co-located or operating in conjunction with any other antenna or transmitter.

The term "IC:" before the certification/registration number only signifies that Industry Canada technical specifications were met.

Auxiliary Power Points

12 Volt DC Power Point

WARNING



Do not plug optional electrical accessories into the cigar lighter socket. Incorrect use of the cigar lighter can cause damage not covered by the vehicle warranty, and can result in fire or serious injury.

Note: *When you switch the ignition on, you can use the socket to power 12 volt appliances with a maximum current rating of 15 amps.*

If the power supply does not work after you switch the ignition off, switch the ignition on.

Note: *Do not hang any accessory from the accessory plug.*

Note: *Do not use the power point over the vehicle capacity of 12 volt DC 180 watts or a fuse may blow.*

Note: *Always keep the power point caps closed when not in use.*

Do not insert objects other than an accessory plug into the power point. This damages the power point and may blow the fuse.

Run the vehicle for full capacity use of the power point.

To prevent the battery from running out of charge:

- Do not use the power point longer than necessary when the vehicle is not running.
- Do not leave devices plugged in overnight or when you park your vehicle for extended periods.

Locations

Power points may be in the following locations:

- On the front of the center console.
- Inside the center console.

Storage Compartments

CENTER CONSOLE

Stow items in the cup holder carefully as items may become loose during hard braking, acceleration or crashes, including hot drinks which may spill.

The console includes:

- Cup holder.
- Storage compartment.



E209039

Lift the latch to open the storage compartment to access the following features:

- Auxiliary power point.
- Auxiliary audio input jack.
- USB port.
- Media hub.

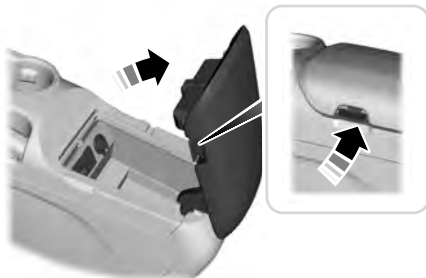

E175706

Locking Storage Bin (If Equipped)

Note: You cannot lock the storage bin when the vehicle is on.

The storage bin locks when you electronically lock the doors. The bin unlocks when you use the remote control to unlock the driver door.

GLASSES HOLDER

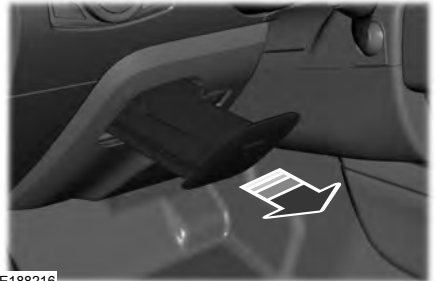

E188216

Press near the center of the door to open it. Pull out the tray.

Starting and Stopping the Engine

GENERAL INFORMATION

WARNINGS



Extended idling at high engine speeds can produce very high temperatures in the engine and exhaust system, creating the risk of fire or other damage.



Do not park, idle or drive your vehicle on dry grass or other dry ground cover. The emission system heats up the engine compartment and exhaust system, creating the risk of fire.



Do not start the engine in a closed garage or in other enclosed areas. Exhaust fumes can be toxic. Always open the garage door before you start the engine.



Exhaust leaks may result in entry of harmful and potentially lethal fumes into the passenger compartment. If you smell exhaust fumes inside your vehicle, have your vehicle inspected immediately. Do not drive if you smell exhaust fumes.

If you disconnect the battery, your vehicle may exhibit some unusual driving characteristics for approximately 5 mi (8 km) after you reconnect it. This is because the engine management system must realign itself with the engine. You can disregard any unusual driving characteristics during this period.

The powertrain control system meets all Canadian interference-causing equipment standard requirements regulating the impulse electrical field or radio noise.

When you start the engine, avoid pressing the accelerator pedal before and during operation. Only use the accelerator pedal when you have difficulty starting the engine.

KEYLESS STARTING

Note: The keyless starting system may not function if the key is close to metal objects or electronic devices such as cellular phones.

Note: A valid key must be located inside your vehicle to switch the ignition on and start the engine.

Ignition Modes



E248637

The keyless starting system has three modes:

Off: Turns the ignition off.

- Without applying the brake pedal, press and release the button once when the ignition is in the on mode, or when the engine is running but the vehicle is not moving.

On: All electrical circuits are operational and the warning lamps and indicators illuminate.

- Without applying the brake pedal, press and release the button once.

Start: Starts the engine.

Starting and Stopping the Engine

- Press the brake pedal (automatic transmission) or clutch pedal (manual transmission), and then press the button for any length of time. An indicator light on the button illuminates when the ignition is on and when the engine starts.

STEERING WHEEL LOCK (if

Equipped)

The steering wheel locks automatically when you leave your vehicle and take the intelligent access key with you. The steering wheel unlocks automatically when you enter your vehicle with the intelligent access key.

Note: *You may need to turn the steering wheel left or right if the wheel does not unlock completely. This may happen in certain situations, such as parking your vehicle on a steep grade.*

STARTING A GASOLINE ENGINE

When you start the engine, the idle speed increases, this helps to warm up the engine. If the engine idle speed does not slow down automatically, have your vehicle checked by an authorized dealer.

Note: *You can crank the engine for a total of 60 seconds (without the engine starting) before the starting system temporarily disables. The 60 seconds does not have to be all at once. For example, if you crank the engine three times for 20 seconds each time, without the engine starting, you reached the 60-second time limit. A message appears in the information display alerting you that you exceeded the cranking time. You cannot attempt to start the engine for at least 15 minutes. After 15 minutes, you are limited to a 15-second engine cranking time. You need to wait 60 minutes before you can crank the engine for 60 seconds again.*

Before starting the engine, check the following:

- Make sure all occupants have fastened their seatbelts.
- Make sure the headlamps and electrical accessories are off.
- Make sure the parking brake is on.
- Move the transmission selector lever to park (P) (automatic transmission) or neutral (manual transmission)

Note: *Do not touch the accelerator pedal.*

Note: *You must have your intelligent access key in the vehicle in order to shift the transmission out of position P.*

1. Fully press the brake pedal.
2. Press the button.

The system does not function if:

- The key frequencies are jammed.
- The key battery has no charge.

If you are unable to start the engine, do the following:

Starting and Stopping the Engine

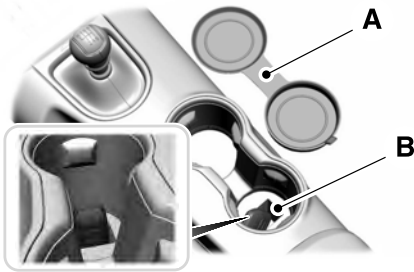

E174956

1. Remove the rubber covering (A) in the cupholder.
2. Place the remote in the backup slot (B) with the buttons facing up and the keyring toward the front of the vehicle.
3. With the key in this position, press the brake pedal (automatic transmission) or clutch pedal (manual transmission), then the START button to switch the ignition on and start your vehicle.

Fast Restart

The fast restart feature allows you to restart the engine within 20 seconds of switching it off, even if a valid key is not present.

Within 20 seconds of switching the engine off, press the brake pedal (automatic transmission) or clutch pedal (manual transmission) and press the button. After 20 seconds have expired, you can no longer restart the engine without the key present inside your vehicle.

Once the engine has started, it remains running until you press the button, even if the system does not detect a valid key. If you open and close a door while the engine is running, the system searches for a valid key. You cannot restart the engine if the system does not detect a valid key within 20 seconds.

Failure to Start

If you cannot start the engine after three attempts, wait 10 seconds and follow this procedure:

1. If your vehicle is equipped with an automatic transmission, fully press the brake pedal. If your vehicle is equipped with a manual transmission, fully press the clutch pedal and apply the handbrake.
2. Move the transmission selector lever to park (P) (automatic transmission) or neutral (manual transmission).
3. Fully press the accelerator pedal and hold it there.
4. Start the engine.

Automatic Engine Shutdown

Your vehicle is equipped with a feature that automatically shuts down the engine if it has been idling for an extended period. The ignition also turns off in order to save battery power. Before the engine shuts down, a message appears in the information display showing a timer counting down from 30 seconds. If you do not intervene within 30 seconds, the engine shuts down. Another message appears in the information display to inform you that the engine has shut down in order to save fuel. Start your vehicle as you normally do.

Automatic Engine Shutdown Override

Note: *You cannot permanently switch off the automatic engine shutdown feature. When you switch it off temporarily, it turns on at the next ignition cycle.*

You can stop the engine shutdown, or reset the timer, at any point before the 30-second countdown has expired by doing any of the following:

Starting and Stopping the Engine

- You can reset the timer by interacting with your vehicle (such as pressing the brake pedal or accelerator pedal).
- You can temporarily switch off the shutdown feature any time the ignition is on (for the current ignition cycle only). Use the information display to do so. See **Information Displays** (page 83).
- During the countdown before engine shutdown, you are prompted to press OK or RESET (depending on your type of information display) to temporarily switch the feature off (for the current ignition cycle only).

Stopping the Engine When Your Vehicle is Stationary

1. Move the transmission selector lever to park (P) (automatic transmission) or neutral (manual transmission).
2. Press the button once.
3. Apply the parking brake.

Note: This switches off the ignition, all electrical circuits, warning lamps and indicators.

Note: If the engine is idling for 30 minutes, the ignition and engine automatically shut down.

Stopping the Engine When Your Vehicle is Moving

WARNING



Switching off the engine when the vehicle is still moving will result in a loss of brake and steering assistance. The steering will not lock, but higher effort will be required. When the ignition is switched off, some electrical circuits, including air bags, warning lamps and indicators may also be off. If the ignition was turned off accidentally, you can shift into neutral (N) and re-start the engine.

1. Move the transmission selector lever to the neutral position and use the brakes to bring your vehicle to a safe stop.
2. When your vehicle has stopped, move the transmission selector lever to park (P) (automatic transmission) or neutral (manual transmission).
3. Press and hold the button for one second, or press it three times within two seconds.
4. Apply the parking brake.

Guarding Against Exhaust Fumes

WARNING



If you smell exhaust fumes inside your vehicle, have your vehicle checked by your authorized dealer immediately. Do not drive your vehicle if you smell exhaust fumes. Carbon monoxide is present in exhaust fumes. Take precautions to avoid its dangerous effects.

Important Ventilating Information

If you stop your vehicle and leave the engine idling for long periods, we recommend that you do one of the following:

- Open the windows at least 1 in (2.5 cm).
- Set your climate control to outside air.

ENGINE BLOCK HEATER (If

Equipped)

WARNINGS



Failure to follow engine block heater instructions could result in property damage or serious personal injury.

Starting and Stopping the Engine

WARNINGS



Do not use your heater with ungrounded electrical systems or two-pronged adapters. There is a risk of electrical shock.



Do not fully close the hood, or allow it to drop under its own weight when using the engine block heater. This could damage the power cable and may cause an electrical short resulting in fire, injury and property damage.

Note: *The heater is most effective when outdoor temperatures are below 0°F (-18°C).*

The heater acts as a starting aid by warming the engine coolant. This allows the climate control system to respond quickly. The equipment includes a heater element (installed in the engine block) and a wire harness. You can connect the system to a grounded 120-volt AC electrical source.

We recommend that you do the following for a safe and correct operation:

- Use a 16-gauge outdoor extension cord that is product certified by Underwriter's Laboratory (UL) or Canadian Standards Association (CSA). This extension cord must be suitable for use outdoors, in cold temperatures, and be clearly marked Suitable for Use with Outdoor Appliances. Do not use an indoor extension cord outdoors. This could result in an electric shock or become a fire hazard.
- Use as short an extension cord as possible.
- Do not use multiple extension cords.
- Make sure that when in operation, the extension cord plug and heater cord plug connections are free and clear of water. This could cause an electric shock or fire.

- Make sure your vehicle is parked in a clean area, clear of combustibles.
- Make sure the heater, heater cord and extension cord are firmly connected.
- Check for heat anywhere in the electrical hookup once the system has been operating for approximately 30 minutes.
- Make sure the system is unplugged and properly stowed before starting and driving your vehicle. Make sure the protective cover seals the prongs of the block heater cord plug when not in use.
- Make sure the heater system is checked for proper operation before winter.

Using the Engine Block Heater

Make sure the receptacle terminals are clean and dry prior to use. Clean them with a dry cloth if necessary.

The heater uses 0.4 to 1.0 kilowatt-hours of energy per hour of use. The system does not have a thermostat. It achieves maximum temperature after approximately three hours of operation. Using the heater longer than three hours does not improve system performance and unnecessarily uses electricity.

Fuel and Refueling

SAFETY PRECAUTIONS

WARNINGS



Do not overfill the fuel tank. The pressure in an overfilled tank may cause leakage and lead to fuel spray and fire.



The fuel system may be under pressure. If you hear a hissing sound near the fuel filler inlet, do not refuel until the sound stops. Otherwise, fuel may spray out, which could cause serious personal injury.



Fuels can cause serious injury or death if misused or mishandled.



Flow of fuel through a fuel pump nozzle can produce static electricity. This can cause a fire if you are filling an ungrounded fuel container.



Fuel may contain benzene, which is a cancer-causing agent.



When refueling always shut the engine off and never allow sparks or open flames near the fuel tank filler valve. Never smoke or use a cell phone while refueling. Fuel vapor is extremely hazardous under certain conditions. Avoid inhaling excess fumes.

Observe the following guidelines when handling automotive fuel:

- Extinguish all smoking materials and any open flames before refueling your vehicle.
- Always turn off the vehicle before refueling.
- Automotive fuels can be harmful or fatal if swallowed. Fuel such as gasoline is highly toxic and if swallowed can cause death or permanent injury. If fuel is swallowed, call a physician immediately, even if no symptoms are immediately apparent. The toxic effects of fuel may not be visible for hours.
- Avoid inhaling fuel vapors. Inhaling too much fuel vapor of any kind can lead to eye and respiratory tract irritation. In severe cases, excessive or prolonged breathing of fuel vapor can cause serious illness and permanent injury.
- Avoid getting fuel liquid in your eyes. If fuel is splashed in the eyes, remove contact lenses (if worn), flush with water for 15 minutes and seek medical attention. Failure to seek proper medical attention could lead to permanent injury.
- Fuels can also be harmful if absorbed through the skin. If fuel is splashed on the skin, clothing or both, promptly remove contaminated clothing and wash skin thoroughly with soap and water. Repeated or prolonged skin contact with fuel liquid or vapor causes skin irritation.
- Be particularly careful if you are taking Antabuse or other forms of Disulfiram for the treatment of alcoholism. Breathing gasoline vapors could cause an adverse reaction, serious personal injury or sickness. If fuel is splashed on the skin, wash the affected areas immediately with plenty of soap and water. Consult a physician immediately if you experience any adverse reactions.

Fuel and Refueling

FUEL QUALITY

Choosing the Right Fuel

Use only UNLEADED gasoline or UNLEADED gasoline blended with a maximum of 15% ethanol in your gasoline vehicle. Flex fuel vehicles have a yellow fuel fill cap or the fuel fill inlet will have a yellow housing or bezel.

Do not use:

- Fuel containing more than 15% ethanol or E-85 fuel.
- Fuel with methanol.
- Fuels containing metallic based additives, including manganese-based compounds.
- Fuels containing the octane booster additive, methylcyclopentadienyl manganese tricarbonyl (MMT).
- Leaded fuel (The use of leaded fuel is prohibited by law).

Note: *Use of any fuel other than recommended fuel can cause powertrain damage, impair the emission control system or cause loss of vehicle performance. Any damage to vehicle that is caused by use of fuel not recommended will not be covered under warranty.*

Octane Recommendations

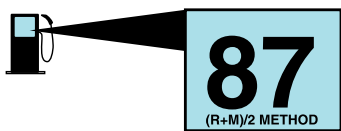

E161513

Do not be concerned if your engine sometimes knocks lightly. However, if it knocks heavily under most driving conditions while you are using fuel with the recommended octane rating, see your authorized dealer to prevent any engine damage.

2.3L EcoBoost and 5.0L V8 Engines

We recommend regular unleaded gasoline with a pump (R+M)/2 octane rating of 87. Some stations offer fuels posted as regular with an octane rating below 87, particularly in high altitude areas. We do not recommend fuels with an octane rating below 87.

To provide improved performance, we recommend premium fuel for severe duty usage, such as trailer tow.

3.7L V6 Engines

We recommend regular unleaded gasoline with a pump (R+M)/2 octane rating of 87. Some stations offer fuels posted as regular with an octane rating below 87, particularly in high altitude areas. We do not recommend fuels with an octane rating below 87.

FUEL FILLER FUNNEL LOCATION

The fuel filler funnel is located in the spare wheel storage tray.

RUNNING OUT OF FUEL

Running out of fuel can cause damage not covered by the vehicle Warranty.

Fuel and Refueling

If your vehicle runs out of fuel:

- Add a minimum of 1.3 gal (5 L) of fuel to restart the engine. If your vehicle is out of fuel and on a steep slope, more fuel may be required.
- You may need to switch the ignition from off to on several times after refueling to allow the fuel system to pump the fuel from the tank to the engine. When restarting, cranking time takes a few seconds longer than normal.

Filling a Portable Fuel Container

Use the following guidelines to avoid electrostatic charge build-up, which can produce a spark, when filling an ungrounded fuel container:

- Only use an approved fuel container to transfer fuel to your vehicle. Place the container on the ground when filling it.
- Do not fill a fuel container when it is inside your vehicle (including the cargo area).
- Keep the fuel pump nozzle in contact with the fuel container when filling it.
- Do not use a device that holds the fuel pump nozzle lever in the fill position.

Adding Fuel From a Portable Fuel Container

WARNINGS



Do not insert the nozzle of a fuel container or an aftermarket funnel into the fuel system filler neck. This may damage the fuel system filler neck or its seal and cause fuel to run onto the ground.



Do not try to pry open or push open the capless fuel system with foreign objects. This could damage the fuel system and its seal and cause injury to you or others.

WARNINGS



Do not dispose of fuel in the household refuse or the public sewage system. Use an authorized waste disposal facility.

When refueling the vehicle fuel tank from a fuel container, use the fuel filler funnel included with your vehicle. See **Fuel Filler Funnel Location** (page 128).

Note: Do not use aftermarket funnels as they will not work with the capless fuel system and can damage it.

When refueling the vehicle fuel tank from a fuel container, do the following:

1. Fully open the fuel tank filler door until it engages.
2. Fully insert the fuel filler funnel into the fuel tank filler pipe opening.



E157452

3. Add fuel to your vehicle from the fuel container.
4. Remove the fuel filler funnel from the fuel tank filler pipe opening.
5. Fully close the fuel tank filler door.
6. Clean the fuel filler funnel and place it back in your vehicle or correctly dispose of it.

Fuel and Refueling

Note: Extra funnels can be purchased from an authorized dealer if you choose to dispose of the funnel.

REFUELING

WARNINGS

 When refueling always shut the engine off and never allow sparks or open flames near the fuel tank filler valve. Never smoke or use a cell phone while refueling. Fuel vapor is extremely hazardous under certain conditions. Avoid inhaling excess fumes.

 The fuel system may be under pressure. If you hear a hissing sound near the fuel filler door, do not refuel until the sound stops. Otherwise, fuel may spray out, which could cause serious personal injury.

 Do not remove the fuel pump nozzle from its fully inserted position when refueling.

 Do not overfill the fuel tank. The pressure in an overfilled tank may cause leakage and lead to fuel spray and fire.

 Stop refueling when the fuel pump nozzle automatically shuts off for the first time. Failure to follow this will fill the expansion space in the fuel tank and could lead to fuel overflowing.

 Wait at least 10 seconds before removing the fuel pump nozzle to allow any residual fuel to drain into the fuel tank.

 Do not try to pry open or push open the capless fuel system with foreign objects. This could damage the fuel system and its seal and cause injury to you or others.

Note: Your vehicle does not have a fuel filler cap.

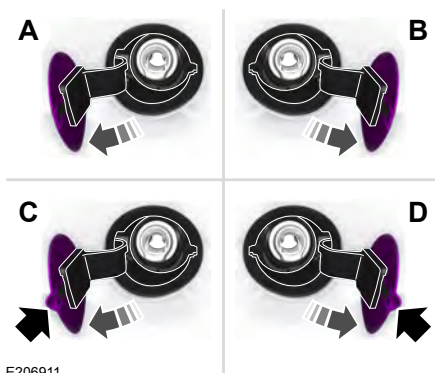

E206911

- A Left-hand side. To open the fuel filler door, press the center rear edge of the fuel filler door and then release.
- B Right-hand side. To open the fuel filler door, press the center rear edge of the fuel filler door and then release.
- C Left-hand side. Pull the rear of the fuel tank filler door to open it.
- D Right-hand side. Pull the rear of the fuel tank filler door to open it.

1. Fully open the fuel tank filler door until it engages.

Fuel and Refueling

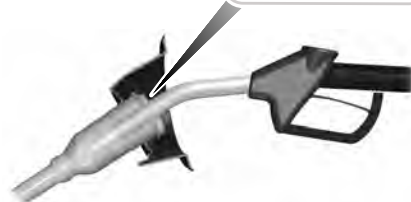
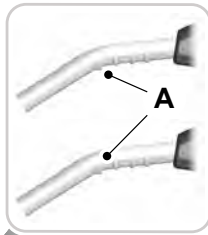

E139202

Note: When you insert the correct size fuel pump nozzle a spring loaded inhibitor will open.

2. Insert the fuel pump nozzle up to the first notch on the nozzle A. Keep it resting on the cover of the fuel tank filler pipe opening.

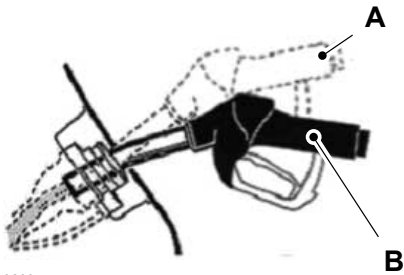

E139203

3. Hold the fuel pump nozzle in position B when refueling. Holding the fuel nozzle in position A can affect the flow of fuel and shut off the fuel nozzle before the fuel tank is full.

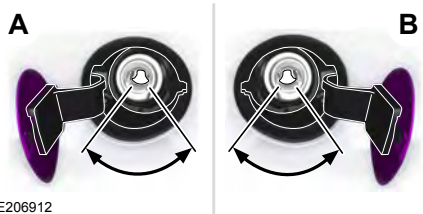

E206912

4. Operate the fuel pump nozzle within the area shown.



E119081

5. Slightly raise the fuel pump nozzle and then slowly remove it.
6. Fully close the fuel tank filler door.

Note: Do not attempt to start the engine if you have filled the fuel tank with incorrect fuel. Incorrect fuel use can cause damage not covered by the vehicle Warranty. Have your vehicle checked immediately.

System Warnings (If Equipped)

If the fuel filler inlet does not fully close a warning message appears in the information display.

1. Stop your vehicle as soon as safely possible and shift the transmission into park (P) or neutral (N).
2. Apply the parking brake and switch the ignition off.
3. Fully open the fuel tank filler door until it engages.
4. Check the fuel filler inlet and the area around it for any items or debris that may be obstructing its movement.

Fuel and Refueling

5. Insert a fuel pump nozzle or the fuel filler funnel provided with your vehicle in to the fuel tank filler pipe opening. This action should dislodge any debris that may be preventing the fuel filler inlet from fully closing.

Note: *If this action corrects the problem the message may not reset immediately. If the message remains and the service engine soon warning lamp appears in the information display, have your vehicle checked as soon as possible.*

FUEL CONSUMPTION

The advertised capacity is the indicated capacity and the empty reserve combined. Indicated capacity is the difference in the amount of fuel in the fuel tank and when the fuel gauge indicates empty.

See **Capacities and Specifications** (page 271).

Note: *The amount of fuel in the empty reserve varies and should not be relied upon to increase driving range.*

Note: *When refueling your vehicle after the fuel gauge indicates empty, you might not be able to refuel the full amount of the advertised capacity due to the empty reserve still present in the fuel tank.*

Filling the Fuel Tank

For consistent results when refueling:

- Always switch the ignition off before refueling. If you leave the engine running, you will get an inaccurate reading.
- Use the same fill rate (low-medium-high) each time you fill the tank.
- Allow no more than two automatic shut-offs when refueling.

Results are most accurate when the filling method is consistent.

Calculating Fuel Economy

Do not measure fuel economy during the first 1,000 mi (1,600 km) of driving (this is your engine's break-in period). A more accurate measurement is obtained after 2,000 mi (3,200 km) to 3,000 mi (4,800 km). Also, fuel expense, frequency of fill ups or fuel gauge readings are not accurate ways to measure fuel economy.

1. Fill the fuel tank completely and record the initial odometer reading.
2. Each time you fill the fuel tank, record the amount of fuel added.
3. After at least three fill ups, fill the fuel tank and record the current odometer reading.
4. Subtract your initial odometer reading from the current odometer reading.
5. To calculate L/100 km (liters per 100 kilometers) fuel consumption, multiply the liters used by 100, then divide by kilometers traveled. To calculate MPG (miles per gallon) fuel consumption, divide miles traveled by gallons used.

Keep a record for at least one month and record the type of driving (city or highway). This provides an accurate estimate of your vehicle's fuel economy under current driving conditions. Keeping records during summer and winter will show how temperature impacts fuel economy.

Conditions

- Heavily loading your vehicle reduces fuel economy.
- Carrying unnecessary weight in your vehicle may reduce fuel economy.
- Adding certain accessories to your vehicle such as bug deflectors, rollbars or light bars, running boards and ski racks may reduce fuel economy.
- Using fuel blended with alcohol may lower fuel economy.

Fuel and Refueling

- Fuel economy may decrease with lower temperatures.
- Fuel economy may decrease when driving short distances.
- You will get better fuel economy when driving on flat terrain than when driving on hilly terrain.

EMISSION CONTROL SYSTEM

WARNINGS



Do not park, idle, or drive your vehicle in dry grass or other dry ground cover.

The emission system heats up the engine compartment and exhaust system, which can start a fire.



Exhaust leaks may result in entry of harmful and potentially lethal fumes into the passenger compartment. If

you smell exhaust fumes inside your vehicle, have your dealer inspect your vehicle immediately. Do not drive if you smell exhaust fumes.

Your vehicle is equipped with various emission control components and a catalytic converter that will enable your vehicle to comply with applicable exhaust emission standards.

To make sure that the catalytic converter and other emission control components continue to work properly:

- Use only the specified fuel listed.
- Avoid running out of fuel.
- Do not turn off the ignition while your vehicle is moving, especially at high speeds.
- Have the items listed in scheduled maintenance information performed according to the specified schedule.

The scheduled maintenance items listed in scheduled maintenance information are essential to the life and performance of your vehicle and to its emissions system.

If you use anything other than Ford, Motorcraft or Ford-authorized parts for maintenance replacements or for service of components affecting emission control, such non-Ford parts should be equivalent to genuine Ford Motor Company parts in performance and durability.

Illumination of the service engine soon indicator, charging system warning light or the temperature warning light, fluid leaks, strange odors, smoke or loss of engine power could indicate that the emission control system is not working properly.

An improperly operating or damaged exhaust system may allow exhaust to enter the vehicle. Have a damaged or improperly operating exhaust system inspected and repaired immediately.

Do not make any unauthorized changes to your vehicle or engine. By law, vehicle owners and anyone who manufactures, repairs, services, sells, leases, trades vehicles, or supervises a fleet of vehicles are not permitted to intentionally remove an emission control device or prevent it from working. Information about your vehicle's emission system is on the Vehicle Emission Control Information Decal located on or near the engine. This decal also lists engine displacement.

Please consult your warranty information for complete details.

Fuel and Refueling

On-Board Diagnostics (OBD-II)

Your vehicle has a computer known as the on-board diagnostics system (OBD-II) that monitors the engine's emission control system. The system protects the environment by making sure that your vehicle continues to meet government emission standards. The OBD-II system also assists a service technician in properly servicing your vehicle.



When the service engine soon indicator illuminates, the OBD-II system has detected a malfunction. Temporary malfunctions may cause the service engine soon indicator to illuminate. Examples are:

1. Your vehicle has run out of fuel—the engine may misfire or run poorly.
2. Poor fuel quality or water in the fuel—the engine may misfire or run poorly.
3. The fuel fill inlet may not have closed properly. See **Refueling** (page 130).
4. Driving through deep water—the electrical system may be wet.

You can correct these temporary malfunctions by filling the fuel tank with good quality fuel, properly closing the fuel fill inlet or letting the electrical system dry out. After three driving cycles without these or any other temporary malfunctions present, the service engine soon indicator should stay off the next time you start the engine. A driving cycle consists of a cold engine startup followed by mixed city and highway driving. No additional vehicle service is required.

If the service engine soon indicator remains on, have your vehicle serviced at the first available opportunity. Although some malfunctions detected by the OBD-II may not have symptoms that are apparent, continued driving with the service engine soon indicator on can result in increased emissions, lower fuel economy, reduced engine and transmission smoothness and lead to more costly repairs.

Readiness for Inspection and Maintenance (I/M) Testing

Some state and provincial and local governments may have Inspection/Maintenance (I/M) programs to inspect the emission control equipment on your vehicle. Failure to pass this inspection could prevent you from getting a vehicle registration.



If the service engine soon indicator is on or the bulb does not work, your vehicle may need service. See On-Board Diagnostics.

Your vehicle may not pass the I/M test if the service engine soon indicator is on or not working properly (bulb is burned out), or if the OBD-II system has determined that some of the emission control systems have not been properly checked. In this case, the vehicle is not ready for I/M testing.

If the vehicle's engine or transmission has just been serviced, or the battery has recently run down or been replaced, the OBD-II system may indicate that the vehicle is not ready for I/M testing. To determine if the vehicle is ready for I/M testing, turn the ignition key to the on position for 15 seconds without cranking the engine. If the service engine soon indicator blinks eight times, it means that the vehicle is not ready for I/M testing; if the service engine soon indicator stays on solid, it means that your vehicle is ready for I/M testing.

Fuel and Refueling

The OBD-II system checks the emission control system during normal driving. A complete check may take several days.

If the vehicle is not ready for I/M testing, you can perform the following driving cycle consisting of mixed city and highway driving:

1. 15 minutes of steady driving on an expressway or highway followed by 20 minutes of stop-and-go driving with at least four 30-second idle periods.
2. Allow your vehicle to sit for at least eight hours with the ignition off. Then, start the vehicle and complete the above driving cycle. The vehicle must warm up to its normal operating temperature. Once started, do not turn off the vehicle until the above driving cycle is complete.

If the vehicle is still not ready for I/M testing, you need to repeat the above driving cycle.

Transmission

MANUAL TRANSMISSION

Using the Clutch

Note: Failure to fully press the clutch pedal to the floor may cause increased shift efforts, prematurely wear transmission components or damage the transmission.

Note: Do not drive with your foot resting on the clutch pedal or use the clutch pedal to hold your vehicle at a standstill while waiting on a hill. These actions will reduce the life of the clutch and could nullify a clutch warranty claim.

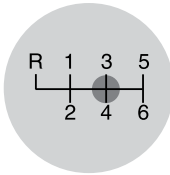

E144954

Manual transmission vehicles have a starter interlock that prevents cranking the engine unless the clutch pedal is fully pressed.

To start the vehicle:

1. Make sure the parking brake is fully set.
2. Press the clutch pedal to the floor, then put the gearshift lever in the neutral position.
3. Start the engine.
4. Press the brake pedal and move the gearshift lever to the desired gear; first (1) or reverse (R).
5. Release the parking brake, then slowly release the clutch pedal while slowly pressing on the accelerator.

During each shift, the clutch pedal must be fully pressed to the floor. Make sure the floor mat is properly positioned so it doesn't interfere with the full extension of the clutch pedal.

Recommended Shift Speeds

Note: Do not downshift into first (1) when your vehicle is moving faster than 15 mph (24 km/h). This will damage the clutch.

2.3L

Recommended upshifts (for best fuel economy) when accelerating	
Shift from:	
1 - 2	15 mph (24 km/h)
2 - 3	24 mph (39 km/h)
3 - 4	35 mph (56 km/h)
4 - 5	41 mph (66 km/h)
5 - 6	50 mph (80 km/h)

3.7L with 3.15 Axle Ratio

Recommended upshifts (for best fuel economy) when accelerating	
Shift from:	
1 - 2	13 mph (21 km/h)
2 - 3	26 mph (42 km/h)
3 - 4	37 mph (60 km/h)
4 - 5	43 mph (69 km/h)
5 - 6	59 mph (95 km/h)

Transmission

3.7L with 3.55 Axle Ratio

Recommended upshifts (for best fuel economy) when accelerating	
Shift from:	
1 - 2	13 mph (21 km/h)
2 - 3	24 mph (39 km/h)
3 - 4	33 mph (53 km/h)
4 - 5	39 mph (63 km/h)
5 - 6	43 mph (69 km/h)

5.0L

Recommended upshifts (for best fuel economy) when accelerating	
Shift from:	
1 - 2	13 mph (21 km/h)
2 - 3	24 mph (39 km/h)
3 - 4	31 mph (50 km/h)
4 - 5	39 mph (63 km/h)
5 - 6	43 mph (69 km/h)

Reverse

Note: Make sure that your vehicle is at a complete stop before you shift into reverse (R). Failure to do so may damage the transmission.

1. Press the clutch pedal to the floor to disengage clutch.
2. Shift into reverse (R) by raising the collar below the gearshift knob up, then moving the lever fully to the left, then forward.

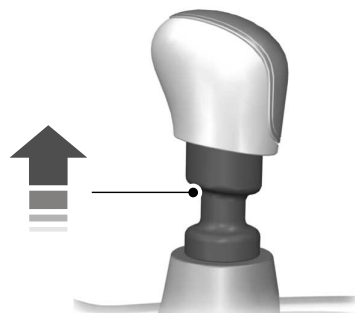

E99067

Note: The gearshift lever can only be moved to reverse (R) by raising the collar below the gearshift knob up before shifting to reverse. This is a lockout feature which protects the transmission from accidentally engaging reverse (R) when intending to select first (1).

If reverse (R) is not fully engaged, press the clutch pedal down and return the gearshift to the neutral position. Release the clutch pedal for a moment, then raise the collar and shift to reverse (R) again.

Parking Your Vehicle

WARNING



Do not park your vehicle in neutral (N), it may move unexpectedly and injure someone. Use first (1) gear and set the parking brake fully.

To park your vehicle:

1. Apply the brake and shift into the neutral position.
2. Fully apply the parking brake, hold the clutch pedal down, then shift into first (1).
3. Turn the ignition off.

Transmission

AUTOMATIC TRANSMISSION

(If Equipped)

WARNINGS



Always set the parking brake fully and make sure you shift the gearshift lever to park (P). Switch the ignition off and remove the key whenever you leave your vehicle.



Do not apply the brake pedal and accelerator pedal simultaneously. Applying both pedals simultaneously for more than a few seconds will limit engine rpm, which may result in difficulty maintaining speed in traffic and could lead to serious injury.

Understanding the Positions of Your Automatic Transmission

Putting your vehicle in gear:

1. Fully press down the brake pedal.
2. Press and hold the button on the top of the gearshift lever.
3. Move the gearshift lever into the desired gear.
4. Release the button and your transmission remains in the selected gear.



E174572

Park (P)

This position locks the transmission and prevents the rear wheels from turning. Come to a complete stop before putting your vehicle into and out of park (P).

Reverse (R)

With the selector in reverse (R), your vehicle moves backward. Always come to a complete stop before shifting into and out of reverse (R).

Neutral (N)

With the selector in neutral (N), you can start your vehicle and it is free to roll. Hold the brake pedal down while in this position.

Drive (D)

Drive (D) is the normal driving position for the best fuel economy. The overdrive function allows automatic upshifts and downshifts through all gears.

Sport (S)

Putting your vehicle in sport (S):

- Provides additional engine braking and extends lower gear operation to enhance performance for uphill climbs, hilly terrain or mountainous areas. This will increase engine RPM during engine braking.
- Provides additional lower gear operation through the automatic transmission shift strategy.
- Provides gear selection more quickly and at higher engine speeds.

SelectShift Automatic™ Transmission

This feature gives you the ability to change gears up or down as desired.

Transmission

As long as the engine speed does not exceed the maximum allowable limit, downshifts are allowed. SelectShift automatically downshifts at low engine speeds in order to prevent engine stalls.

Note: *Engine damage may occur if you maintain excessive engine revving without shifting.*

SelectShift does not automatically upshift, even if the engine is approaching the RPM limit, unless the accelerator pedal is at full travel.

Pull the + paddle on the steering wheel to activate SelectShift.

- Pull the right paddle (+) to upshift.
- Pull the left paddle (-) to downshift.



SelectShift in drive (D):

- Provides a temporary manual mode for performing more demanding maneuvers where extra control of gear selection is required (for example, when towing or overtaking). This mode will hold a selected gear for a temporary period of time dependent on driver inputs (for example, steering or accelerator pedal input).

SelectShift in sport (S):

- Provides a permanent manual gear selection where full control of gear selection is required.

To exit SelectShift mode shift the transmission into another gear (for example, drive [D]).

The instrument cluster displays your currently selected gear. If a gear is requested but not available due to vehicle conditions (low speed, too high engine speed for requested gear selection), the current gear flashes three times.

Upshift to the recommended shift speeds according to this following chart:

Upshifts when accelerating (recommended for best fuel economy)	
Shift from:	
1 - 2	15 mph (24 km/h)
2 - 3	25 mph (40 km/h)
3 - 4	40 mph (64 km/h)
4 - 5	45 mph (72 km/h)
5 - 6	50 mph (80 km/h)

Brake-Shift Interlock

WARNINGS



Do not drive your vehicle until you verify that the brake lamps are working.



When doing this procedure, you need to take the transmission out of park (P) which means your vehicle can roll freely. To avoid unwanted vehicle movement, always fully set the parking brake prior to doing this procedure. Use wheels chocks if appropriate.



If the parking brake is fully released, but the brake warning lamp remains illuminated, the brakes may not be working properly. Have your vehicle checked as soon as possible.

Note: *Contact an authorized dealer as soon as possible if this procedure is used.*

Note: *For some markets, this feature will be disabled.*

Transmission

Use the brake shift interlock lever to move the gearshift lever from the park position in the event of an electrical malfunction or if your vehicle has a dead battery.

Apply the parking brake and switch the ignition off before performing this procedure.



E184747

1. Using a flat head screwdriver or similar tool, remove the chrome bezel and gearshift bracket at the base of the gearshift lever.

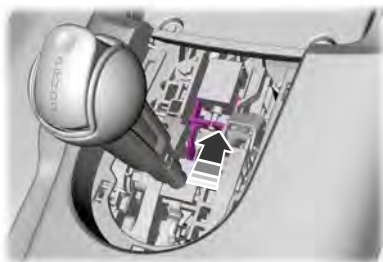

E174501

2. Locate the white release lever and slide the lever forward while pulling the gearshift lever out of the park (P) position and into the neutral (N) position.
3. Reinstall the console.
4. Start your vehicle and release the parking brake.

Automatic Transmission Adaptive Learning

This feature is designed to increase durability and provide consistent shift feel over the life of your vehicle. A new vehicle or transmission may have firm or soft shifts. This operation is normal and does not affect function or durability of the transmission. Over time, the adaptive learning process will fully update transmission operation. Additionally, whenever you disconnect the battery is or install a new battery, the system must relearn the strategy.

If Your Vehicle Gets Stuck In Mud or Snow

Note: Do not rock your vehicle if the engine is not at normal operating temperature or damage to the transmission may occur.

Note: Do not rock your vehicle for more than a minute or damage to the transmission and tires may occur, or the engine may overheat.

If your vehicle gets stuck in mud or snow, you may rock it out by shifting between forward and reverse gears, stopping between shifts in a steady pattern. Press lightly on the accelerator in each gear.

Rear Axle

LIMITED SLIP DIFFERENTIAL

(If Equipped)

This axle provides added traction on slippery surfaces, particularly when one wheel is on a poor traction surface. Under normal conditions, the limited-slip axle functions like a standard rear axle. The axle may exhibit a slight noise or vibration during tight turns with low vehicle speed. This is normal behavior and indicates the axle is working.

Traction-Lok™ and TORSEN™ Axles (If Equipped)

These axles provide improved traction on slippery and loose surfaces, particularly when one wheel is on a poor traction surface. Under normal conditions, these axles function like a standard rear axle.

Extended use of tire sizes other than the manufacturer's specified tire size on these axles could result in a permanent reduction in effectiveness. This loss does not affect your normal driving and should not be noticeable.

Brakes

GENERAL INFORMATION

Note: Occasional brake noise is normal. If a metal-to-metal, continuous grinding or continuous squeal sound is present, the brake linings may be worn-out. Have the system checked by an authorized dealer. If your vehicle has continuous vibration or shudder in the steering wheel while braking, have it checked by an authorized dealer.

Note: Brake dust may accumulate on the wheels, even under normal driving conditions. Some dust is inevitable as the brakes wear and does not contribute to brake noise. See **Cleaning the Wheels** (page 235).



See **Warning Lamps and Indicators** (page 79).

Wet brakes result in reduced braking efficiency. Gently press the brake pedal a few times when driving from a car wash or standing water to dry the brakes.

Brake Over Accelerator

In the event the accelerator pedal becomes stuck or entrapped, apply steady and firm pressure to the brake pedal to slow the vehicle and reduce engine power. If you experience this condition, apply the brakes and bring your vehicle to a safe stop. Move the transmission to park (P), switch the engine off and apply the parking brake. Inspect the accelerator pedal for any interference. If none are found and the condition persists, have your vehicle towed to the nearest authorized dealer.

Brake Assist

Brake assist detects when you brake rapidly by measuring the rate at which you press the brake pedal. It provides maximum braking efficiency as long as you press the pedal, and can reduce stopping distances in critical situations.

Anti-lock Brake System

This system helps you maintain steering control during emergency stops by keeping the brakes from locking.



This lamp momentarily illuminates when you turn the ignition on. If the light does not illuminate during start up, remains on or flashes, the system may be disabled. Have the system checked by an authorized dealer. If the anti-lock brake system is disabled, normal braking is still effective.



If the brake warning lamp remains illuminated after you release the parking brake, have the system checked by an authorized dealer.

HINTS ON DRIVING WITH ANTI-LOCK BRAKES

Note: When the system is operating, the brake pedal may pulse and may travel further. Maintain pressure on the brake pedal. You may also hear a noise from the system. This is normal.

The anti-lock braking system will not eliminate the risks when:

- You drive too closely to the vehicle in front of you.
- Your vehicle is hydroplaning.
- You take corners too fast.
- The road surface is poor.

Brakes

PARKING BRAKE

Vehicles With Automatic Transmission

WARNING



Always set the parking brake and leave your vehicle with the transmission in park (P).

Note: If you park your vehicle on a hill and facing uphill, shift into park (P) and turn the steering wheel away from the curb.

Note: If you park your vehicle on a hill and facing downhill, shift into park (P) and turn the steering wheel toward the curb.

Vehicles with Manual Transmission

WARNING



If your vehicle has a manual transmission, shift into first or reverse gear. If your vehicle has an automatic transmission, shift into park (P).

Note: If you park your vehicle on a hill and facing uphill, select first gear and turn the steering wheel away from the curb.

Note: If you park your vehicle on a hill and facing downhill, select reverse gear and turn the steering wheel toward the curb.

All Vehicles

WARNING



If the parking brake is fully released, but the brake warning lamp remains illuminated, the brakes may not be working properly. Have your vehicle checked as soon as possible.



E223664

To set the parking brake, pull the parking brake handle up as far as possible.

To release the parking brake:

1. Press and hold the button at the end of the parking brake handle.
2. Pull the handle up slightly, then push the handle down.

HILL START ASSIST

WARNINGS



The system does not replace the parking brake. When you leave your vehicle, always apply the parking brake and shift the transmission into park (P) for automatic transmission or first gear for manual transmission.



You must remain in your vehicle when the system turns on. At all times, you are responsible for controlling your vehicle, supervising the system and intervening, if required. Failure to take care may result in the loss of control of your vehicle, serious personal injury or death.



The system turns off if there is a malfunction or if you excessively rev the engine.

Brakes

The system makes it easier to pull away when your vehicle is on a slope without the need to use the parking brake.

When the system activates, your vehicle remains stationary on a slope for a few seconds after you release the brake pedal. This allows you time to move your foot from the brake to the accelerator pedal. The brakes release when the engine has developed sufficient torque to prevent your vehicle from rolling down the slope. This is an advantage when pulling away on a slope, for example from a car park ramp, traffic lights or when reversing uphill into a parking space.

The system activates on any slope that causes your vehicle to roll.

Note: *There is no warning lamp to indicate the system is either on or off.*

Using Hill Start Assist

1. Press the brake pedal to bring your vehicle to a complete standstill. Keep the brake pedal pressed and shift into first gear when facing uphill or reverse (R) when facing downhill.
2. The system activates if the sensors detect that your vehicle is on a slope.
3. When you remove your foot from the brake pedal, your vehicle remains on the slope without rolling away for a few seconds. This hold time increases if you are in the process of driving off.
4. Pull away in the normal manner.

Switching the System On and Off

Vehicles with Manual Transmission

You can switch this feature on or off in the information display. The system remembers the last setting when you start your vehicle.

Vehicles with Automatic Transmission

The system turns on when you switch the ignition on and you cannot switch the system off.

Traction Control

PRINCIPLE OF OPERATION

The traction control system helps avoid drive wheel spin and loss of traction.

If your vehicle begins to slide, the system applies the brakes to individual wheels and, when needed, reduces engine power at the same time. If the wheels spin when accelerating on slippery or loose surfaces, the system reduces engine power in order to increase traction.

USING TRACTION CONTROL

WARNING



The stability and traction control light illuminates steadily if the system detects a failure. Make sure you did not manually disable the traction control system using the switch. If the stability control and traction control light is still illuminating steadily, have the system serviced by an authorized dealer immediately. Operating your vehicle with traction control disabled could lead to an increased risk of loss of vehicle control, vehicle rollover, personal injury and death.

The system automatically turns on each time you switch the ignition on.

If your vehicle is stuck in mud or snow, switching traction control off may be beneficial as this allows the wheels to spin.

Note: *When you switch traction control off, stability control remains fully active.*

Switching the System Off

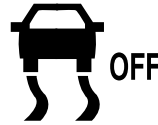

E166706

The switch for the stability and traction control system is on the instrument panel.

When you switch the system off, a message and an illuminated icon appear on the instrument cluster.

Use the switch again to return the traction control system to normal operation.

Your vehicle may have MyKey restrictions regarding this feature. See **Principle of Operation** (page 51).

System Indicator Lights and Messages



The stability and traction control light temporarily illuminates on engine start-up and flashes:

- When a driving condition activates either of the systems.
- If a problem occurs in either of the systems.



The stability and traction control off light temporarily illuminates on engine start-up and stays on:

- When you switch the traction control system off.
- When you select an alternative stability control mode.

Stability Control

PRINCIPLE OF OPERATION

WARNINGS



Vehicle modifications involving braking system, aftermarket roof racks, suspension, steering system, tire construction and wheel and tire size may change the handling characteristics of your vehicle and may adversely affect the performance of the electronic stability control system. In addition, installing any stereo loudspeakers may interfere with and adversely affect the electronic stability control system. Install any aftermarket stereo loudspeaker as far as possible from the front center console, the tunnel, and the front seats in order to minimize the risk of interfering with the electronic stability control sensors. Reducing the effectiveness of the electronic stability control system could lead to an increased risk of loss of vehicle control, vehicle rollover, personal injury and death.



Remember that even advanced technology cannot defy the laws of physics. It's always possible to lose control of a vehicle due to inappropriate driver input for the conditions. Aggressive driving on any road condition can cause you to lose control of your vehicle increasing the risk of personal injury or property damage. Activation of the electronic stability control system is an indication that at least some of the tires have exceeded their ability to grip the road; this could reduce the operator's ability to control the vehicle potentially resulting in a loss of vehicle control, vehicle rollover, personal injury and death. If your electronic stability control system activates, **SLOW DOWN**.

The system automatically turns on each time you switch the ignition on.

If a fault occurs in either the stability control or the traction control system, you may experience the following conditions:

- The stability and traction control light illuminates steadily.
- The stability control and traction control systems do not enhance your vehicle's ability to maintain traction of the wheels.

If a driving condition activates either the stability control or the traction control system you may experience the following conditions:

- The stability and traction control light flashes.
- Your vehicle slows down.
- Reduced engine power.
- A vibration in the brake pedal.
- The brake pedal is stiffer than usual.
- If the driving condition is severe and your foot is not on the brake, the brake pedal may move as the system applies higher brake force.

The stability control system has several features built into it to help you maintain control of your vehicle:

Electronic Stability Control

The system enhances your vehicle's ability to prevent skids or lateral slides by applying brakes to one or more of the wheels individually and, if necessary, reducing engine power.

Traction Control

The system enhances your vehicle's ability to maintain traction of the wheels by detecting and controlling wheel spin. See **Using Traction Control** (page 145).

Stability Control

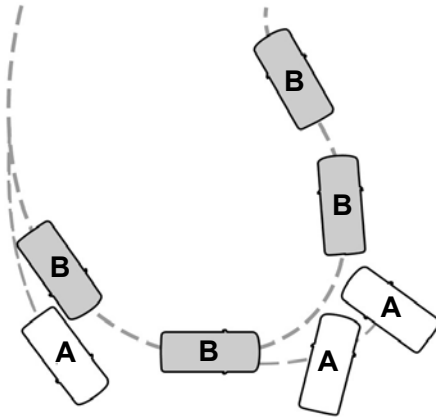

E72903

A Vehicle without stability control

skidding off its intended route.

B Vehicle with stability control maintaining control on a slippery surface.

USING STABILITY CONTROL

Electronic Stability Control

The system automatically turns on each time you switch the ignition on. The electronic stability control portion of the system is disabled when the transmission is in reverse (R) or, on some models, if you press and hold the electronic stability control button for more than five seconds when you apply the brakes and the vehicle is at a stop. You can switch off the traction control portion of the system independently. See **Using Traction Control** (page 145).

ESC features				
Button functions	Mode	Stability control off light	Electronic stability control	Traction control system
Default at start-up	-	On during bulb check	Enabled	Enabled
Button pressed momentarily	Traction control off	On	Enabled	Disabled
Button pressed twice rapidly	Sport mode (if equipped)	On	Enabled	Enabled
Button pressed and held more than five seconds	ESC disabled	On	Disabled	Disabled
Button pressed again after deactivation	ESC fully enabled	Off	Enabled	Enabled

Stability Control

Note: Do not use Sport mode on public roadways.

Some models may also come equipped with a sport mode which allows the driver to reduce normal electronic stability control system intervention and provide a more spirited driving experience. To enter sport mode, toggle the stability control button twice rapidly. The message appears in the information display that the system is now in sport mode.

For vehicles equipped with the selectable drive mode feature, electronic stability control sport mode is not available. You can utilize the performance oriented electronic stability control mode by selecting track drive mode. In this mode, electronic stability control intervention is reduced and tuned specifically for track use only and is not for use on public roads. In all of the selectable drive modes, you can disable traction control and electronic stability control with the electronic stability control switch.

Line Lock (If Equipped)

Line Lock is a feature intended for use at tracks only and should not be used on public roadways. Use of this feature will result in significantly increased rear tire wear. It is intended to condition the rear tires to maximize traction prior to track use. Line Lock maintains brake force at the front wheels, allowing the rear wheels to spin with minimal vehicle movement.

This feature is located in the Track Apps menu. Make selections through the 5-way information display control and OK button located on the steering wheel.

Using Line Lock

There are three Line Lock stages:

- Initiated.
- Engaged.
- Off.

Initiating Line Lock

The initiation stage verifies that the vehicle is ready for Line Lock function, and confirms driver intent. Follow the prompts in the information display in to initiate Line Lock.

The following conditions must be met to initialize Line Lock:

- The vehicle is on a level surface.
- The engine is running.
- The vehicle is traveling less than 25 mph (40 km/h).
- Selectable Drive Mode is not in wet mode (if equipped).
- There are no electronic stability control faults.

If you want to cancel Line Lock once it is initialized, press the left information display control. Once initiated, Line Lock is prepared for activation and will remain initiated up to 25 mph (40 km/h). If vehicle speed exceeds 25 mph (40 km/h), Line Lock will be automatically canceled.

Engaging Line Lock

Follow the prompts in the information display to engage Line Lock after it is initialized. To engage, firmly apply the brakes. Then press the OK button. Once engaged, release the brake pedal. The front brakes will remain applied and the rear brakes will release. At this point, the engagement timer is initiated and shown on the driver information display.

The following conditions must be met to engage Line Lock:

- The vehicle is on a level surface.
- The engine is running.

Stability Control

- The vehicle is stopped.
- The parking brake is not applied.
- The driver door is closed.
- The transmission is in a forward gear.
- Selectable Drive Mode is not in wet mode (if equipped).
- There are no electronic stability control faults.
- The steering wheel must be in the straight ahead position.

Releasing Line Lock

While Line Lock is engaged, you can exit (release) the feature using the OK button. When you press the OK button, Line Lock releases immediately and normal vehicle function will resume. When Line Lock is engaged, a countdown timer shows the remaining time before Line Lock is released automatically. If you exceed the time limit, or another vehicle condition requires Line Lock to release, the system will safely disengage and normal vehicle function will resume.

Note: *If the brake pedal is applied while Line Lock is engaged, Line Lock automatically cancels and normal brake function resumes.*

Parking Aids

PRINCIPLE OF OPERATION

WARNINGS



To help avoid personal injury, please read and understand the limitations of the system as contained in this section. Sensing is only an aid for some (generally large and fixed) objects when moving on a flat surface at parking speeds. Certain objects with surfaces that absorb ultrasonic waves, surrounding vehicle's parking aid systems, traffic control systems, fluorescent lamps, inclement weather, air brakes, and external motors and fans may also affect the function of the sensing system; this may include reduced performance or a false activation.



To help avoid personal injury, always use caution when in reverse (R) and when using the sensing system.



This system is not designed to prevent contact with small or moving objects. The system is designed to provide a warning to assist the driver in detecting large stationary objects to avoid damaging your vehicle. The system may not detect smaller objects, particularly those close to the ground.



Certain add-on devices such as large trailer hitches, bike or surfboard racks and any device that may block the normal detection zone of the system, may create false beeps.

Note: *Keep the sensors, located on the bumper or fascia, free from snow, ice and large accumulations of dirt. If the sensors are covered, the system's accuracy can be affected. Do not clean the sensors with sharp objects.*

Note: *If your vehicle sustains damage to the bumper or fascia, leaving it misaligned or bent, the sensing zone may be altered causing inaccurate measurement of obstacles or false alarms.*

Note: *The sensing system cannot be turned off when a MyKey is present. See **Principle of Operation** (page 51).*

Note: *If you attach certain add-on devices such as a trailer or bike rack, the rear sensing system may detect that add-on device and therefore provide warnings. It is suggested that you disable the rear sensing system when you attach an add-on device to your vehicle to prevent these warnings.*

The sensing system warns the driver of obstacles within a certain range of your vehicle. The system turns on automatically whenever you switch the ignition on.



You can turn the system on or off by pressing the parking aid button. If your vehicle does not have a parking aid button, the system can be switched off through the information display menu or from the pop-up message that appears once you shift the transmission into reverse (R). See **General Information** (page 83).

If a fault is present in the system, a warning message appears in the information display. See **Information Messages** (page 91).

REAR PARKING AID

The rear sensors are only active when the transmission is in reverse (R). As your vehicle moves closer to the obstacle, the rate of the audible warning increases. When the obstacle is less than 12 in (30 cm) away, the warning sounds continuously. If the system detects a stationary or receding object farther than 12 in (30 cm) from the corners of the bumper, the tone sounds for only three seconds. Once the system detects an object approaching, the warning sounds again.

Parking Aids



E130178

Coverage area of up to 6 ft (1.8 m) from the rear bumper. There may be decreased coverage area at the outer corners of the bumper.

The system detects certain objects while the transmission is in reverse (R) :

- Your vehicle is moving toward a stationary object at a speed of 3 mph (5 km/h) or less.
- Your vehicle is not moving, but a moving object is approaching the rear of your vehicle at a speed of 3 mph (5 km/h) or less.
- Your vehicle is moving at a speed of less than 3 mph (5 km/h) and a moving object is approaching the rear of your vehicle at a speed of less than 3 mph (5 km/h).

The system provides audio warnings only when your vehicle is moving or when your vehicle is stationary and the detected obstacle is less than 12 in (30 cm) away from the bumper.

Obstacle Distance Indicator (If Equipped)

The system provides obstacle distance indication through the information display. The distance indicator displays when the transmission is in reverse (R).

The indicator displays:

- As the distance to the obstacle decreases the indicator blocks illuminate and move towards the vehicle icon.
- If there is no obstacle detected, the distance indicator blocks are grayed out.

REAR VIEW CAMERA

WARNINGS



The rear view camera system is a reverse aid supplement device that still requires the driver to use it in conjunction with the interior and exterior mirrors for maximum coverage.



Objects that are close to either corner of the bumper or under the bumper, might not be seen on the screen due to the limited coverage of the camera system.



Reverse your vehicle as slow as possible, higher speeds may limit your reaction time to stop your vehicle.



Use caution when the rear cargo door is ajar. If the rear cargo door is ajar, the camera will be out of position and the video image may be incorrect. All guidelines disappear when the rear cargo door is ajar. Some vehicles may not come equipped with guidelines.



Do not switch the camera features on or off when your vehicle is moving.

Parking Aids

The rear view camera system provides a video image of the area behind your vehicle.

During operation, lines appear in the display which represent your vehicle's path and proximity to objects behind your vehicle.

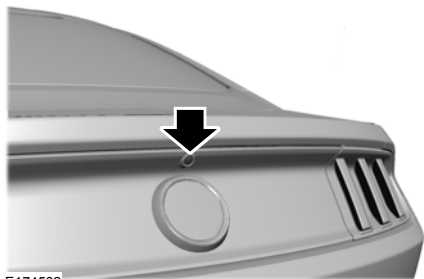

The camera is located on the rear cargo door.

Using the Rear View Camera System

The rear view camera system displays what is behind your vehicle when you place the transmission in reverse (R).

Note: *The reverse sensing system is not effective at speeds above 3 mph (5 km/h) and may not detect certain angular or moving objects.*

The system uses two types of guides to help you see what is behind your vehicle:

- Fixed guidelines: Show the actual path your vehicle is moving in while reversing in a straight line. This can be helpful when backing into a parking space or aligning your vehicle with another object behind you.
- Centerline: Helps align the center of your vehicle with an object.

Note: *If the transmission is in reverse (R) and the luggage compartment is open, no camera features will display.*

The camera may not operate correctly under the following conditions:

- Nighttime or dark areas if the reverse lamps are not operating.
- Mud, water or debris obstructs the camera's view. Clean the lens with a soft, lint-free cloth and non-abrasive cleaner.
- The camera is misaligned due to damage to the rear of your vehicle.

Camera Guidelines

Note: *Active guidelines are only available when the transmission is in reverse (R).*

Note: *Upon a battery disconnect, the active guidelines may not be functional until your vehicle has been driven a short distance and exceeds a speed of 12 mph (20 km/h).*

Parking Aids

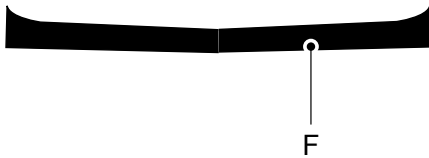
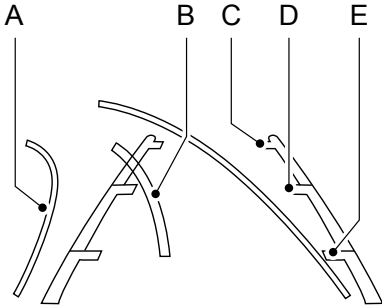

E142436

- A Active guidelines
- B Centerline
- C Fixed guideline: Green zone
- D Fixed guideline: Yellow zone
- E Fixed guideline: Red zone
- F Rear bumper

Active guidelines only show with fixed guidelines. To use active guidelines, turn the steering wheel to point the guidelines toward an intended path. If the steering wheel position changes while reversing, your vehicle might deviate from the original intended path.

The fixed and active guidelines fade in and out depending on the steering wheel position. The active guidelines do not show when the steering wheel position is straight.

Always use caution while reversing. Objects in the red zone are closest to your vehicle and objects in the green zone are farther away. Objects are getting closer to your vehicle as they move from the green zone to the yellow or red zones. Use the side view mirrors and rear view mirror to get better coverage on both sides and rear of your vehicle.

Manual Zoom

WARNING



When manual zoom is on, the full area behind your vehicle may not show. Be aware of your surroundings when using the manual zoom feature.

Note: Manual zoom is only available when the transmission is in reverse (R). When manual zoom is enabled, only the centerline is shown.

Selectable settings for this feature are Zoom in (+) and Zoom out (-). Press the symbol in the camera screen to change the view. The default setting is Zoom OFF.

This feature allows you to get a closer view of an object behind your vehicle. The zoomed image keeps the bumper in the image to provide a reference. The zoom is only active while the transmission is in reverse (R). When the transmission shifts out of reverse (R), the feature automatically turns off and must be reset when it is used again.

Camera System Settings

The rear view camera system settings can be accessed through the display screen. See **General Information** (page 83).

Parking Aids

Enhanced Park Aids or Park Pilot

Selectable settings for this feature are ON and OFF.

The system uses red, yellow and green highlights that appear on top of the video image when any of the sensing systems detect an object.

Vehicles equipped with touchscreen

The system will provide an image of your vehicle and the sensor zones. The zones will highlight green, yellow and red when the parking aid sensors detect an object in the coverage area.

The coverage area is up to 6 ft (1.8 m) from the rear bumper. There is decreased coverage area at the outer corners of the bumper.

When shifting the transmission out of reverse (R) and into any gear other than park (P), the camera image remains in the display until:

- Your vehicle speed sufficiently increases.
- You shift your vehicle into park (P).
- You pull the hand brake on vehicles with a manual transmission.



E130178

For additional information of the zone coverage and the rear sensing system. See **Principle of Operation** (page 150).

Rear Camera Delay

Selectable settings for this feature are ON and OFF.

The default setting for the rear camera delay is OFF.

Cruise Control

PRINCIPLE OF OPERATION

Cruise control lets you maintain a set speed without keeping your foot on the accelerator pedal. You can use cruise control when your vehicle speed is greater than 20 mph (30 km/h).

USING CRUISE CONTROL

WARNINGS



Do not use cruise control on winding roads, in heavy traffic or when the road surface is slippery. This could result in loss of vehicle control, serious injury or death.



When you are going downhill, your vehicle speed could increase above the set speed. The system does not apply the brakes.

Note: Cruise control disengages if the vehicle speed decreases more than 10 mph (16 km/h) below the set speed when driving uphill.

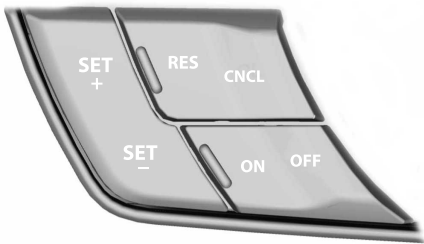

E176993

The cruise controls are on the steering wheel.

Switching Cruise Control On

Press **ON**.



The indicator appears in the information display.

Setting the Cruise Speed

1. Drive to desired speed.
2. Press **SET+** or **SET-**.
3. Take your foot off the accelerator pedal.

Note: The indicator changes color.

Changing the Set Speed

Note: If you accelerate by pressing the accelerator pedal, the set speed will not change. When you release the accelerator pedal, your vehicle returns to the speed that you previously set.

- Press **SET+** or **SET-** to change the set speed in small increments.
- Press the accelerator or brake pedal until you reach the desired speed. Press **SET+** or **SET-**.
- Press and hold **SET+** or **SET-**. Release the control when you reach the desired speed.

Canceling the Set Speed

Press **CNCL** or tap the brake pedal. The set speed does not erase.

Resuming the Set Speed

Press **RES**.

Switching Cruise Control Off









Note: You erase the set speed when you switch the system off.

Press **OFF** when the system is in standby mode, or switch the ignition off.

Cruise Control

USING ADAPTIVE CRUISE CONTROL (If Equipped)

WARNINGS

-  Always pay close attention to changing road conditions when using adaptive cruise control. The system does not replace attentive driving. Failing to pay attention to the road may result in a crash, serious injury or death.
-  Do not use the adaptive cruise control when entering or leaving a highway, on roads with intersections or roundabouts or non-vehicular traffic or roads that are winding, slippery, unpaved, or steep slopes.
-  Do not use the system in poor visibility, for example fog, heavy rain, spray or snow.
-  Do not use tire sizes other than those recommended because this can affect the normal operation of the system. Failure to do so may result in a loss of vehicle control, which could result in serious injury.
-  Adaptive cruise control may not detect stationary or slow moving vehicles below 6 mph (10 km/h).
-  Adaptive cruise control does not detect pedestrians or objects in the road.
-  Adaptive cruise control does not detect oncoming vehicles in the same lane.
-  Adaptive cruise control is not a crash warning or avoidance system.

Note: *It is your responsibility to stay alert, drive safely and be in control of the vehicle at all times.*

The system adjusts your vehicle speed to maintain the set gap between you and the vehicle in front of you in the same lane. You can select four gap settings.

The system uses a radar sensor that projects a beam directly in front of your vehicle.

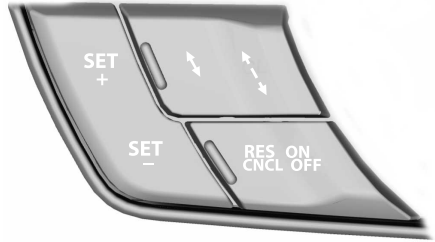

E177068

The adaptive cruise controls are on the steering wheel.

Switching Adaptive Cruise Control On

Press **ON**.



The indicator, current gap setting and set speed appear in the information display.

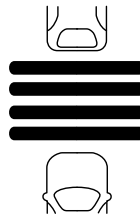

E164805

Setting the Adaptive Cruise Speed

Note: *When adaptive cruise control is active, the speedometer may vary slightly from the set speed displayed in the information display.*

Cruise Control

1. Drive to desired speed.
2. Press **SET+** or **SET-**.
3. A green indicator light, the current gap setting and your set speed appear in the information display.
4. Take your foot off the accelerator pedal.

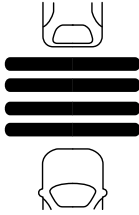

E164805

5. A vehicle graphic illuminates if there is a vehicle detected in front of you.

Following a Vehicle

WARNINGS



When following a vehicle, your vehicle does not decelerate automatically to a stop, nor does your vehicle always decelerate quickly enough to avoid a crash without driver intervention. Always apply the brakes when necessary. Failing to do so may result in a crash, serious injury or death.



Adaptive cruise control only warns of vehicles detected by the radar sensor. In some cases there may be no warning or a delayed warning. You should always apply the brakes when necessary. Failure to do so may result in a crash, serious injury or death.

Note: When you are following a vehicle and you switch on a direction indicator, adaptive cruise control may provide a small temporary acceleration to help you pass.

Note: The brakes may emit noise when applied by the system.

When a vehicle ahead of you enters the same lane or a slower vehicle is ahead in the same lane, the vehicle speed adjusts to maintain a preset gap distance. A vehicle graphic illuminates in the instrument cluster.

Your vehicle maintains a consistent gap from the vehicle ahead until:

- The vehicle in front of you accelerates to a speed above the set speed.
- The vehicle in front of you moves out of the lane you are in.
- Your vehicle speed falls below 12 mph (20 km/h).
- You set a new gap distance.

The system applies the brakes to slow your vehicle to maintain a safe gap distance from the vehicle in front. The system only applies limited braking. You can override the system by applying the brakes.

If the system determines that its maximum braking level will not be sufficient, an audible warning sounds when the system continues to brake. A red warning bar displays on the windshield and you must take immediate action.

Setting the Gap Distance

Note: The gap setting is time dependent and therefore the distance automatically adjusts with your vehicle speed.

Note: It is your responsibility to select a gap appropriate to the driving conditions.

You can decrease or increase the distance between your vehicle and the vehicle in front by pressing the gap control.

Cruise Control

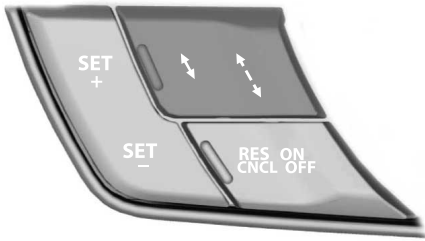

E177070

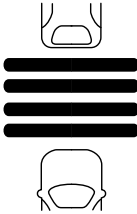

E164805

The selected gap appears in the information display as shown by the bars in the image.

Adaptive Cruise Control Gap Settings

Graphic display, bars indicated between vehicles	Dynamic behavior
1	Sport.
2	Normal.
3	Normal.
4	Comfort.

Each time you switch the system on, it selects the last chosen gap setting.

Overriding the Set Speed

WARNING



If you override the system by pressing the accelerator pedal, it does not automatically apply the brakes to maintain a gap from any vehicle ahead.

When you press the accelerator pedal, you override the set speed and gap distance.



When you override the system, the green indicator light illuminates and the vehicle graphic does not appear in the information display.

The system resumes operation when you release the accelerator pedal. The vehicle speed decreases to the set speed, or a lower speed if following a slower vehicle.

Changing the Set Speed

- Press **SET+** or **SET-** to change the set speed in small increments.
- Press the accelerator or brake pedal until you reach the desired speed. Press **SET+** or **SET-**.
- Press and hold **SET+** or **SET-** to change the set speed in large increments. Release the control when you reach the desired speed.

The system may apply the brakes to slow the vehicle to the new set speed. The set speed displays continuously in the information display when the system is active.

Canceling the Set Speed

Press **CNCL** or tap the brake pedal. The set speed does not erase.

Resuming the Set Speed

Note: Only use resume if you are aware of the set speed and intend to return to it.

Cruise Control

Press **RES**. Your vehicle speed returns to the previously set speed and gap setting. The set speed displays continuously in the information display when the system is active.

Automatic Cancellation

Note: *If the engine speed drops too low, an audible warning sounds and a message appears in the information display. Automatic braking releases.*

The system does not operate below 12 mph (20 km/h).

Hilly Condition Usage

Note: *An audible alarm sounds and the system shuts down if it applies brakes for an extended period of time. This allows the brakes to cool. The system functions normally again when the brakes have cooled.*

Select a lower gear during prolonged downhill driving on steep slopes, such as mountainous areas, when the system is active. In such situations, the system needs additional engine braking to reduce the load on the vehicle's regular brake system to prevent the brakes from overheating.

Switching Adaptive Cruise Control Off

Note: *You erase the set speed and gap setting when you switch the system off.*

Press **OFF** when the system is in standby mode, or switch the ignition off.

Detection Issues

WARNINGS



On rare occasions, detection issues can occur due to the road infrastructures, for example bridges, tunnels and safety barriers. In these cases, the system may brake late or unexpectedly. At all times, you are responsible for controlling your vehicle, supervising the system and intervening, if required.



If the system malfunctions, have your vehicle checked as soon as possible.

The radar sensor has a limited field of view. It may not detect vehicles at all or detect a vehicle later than expected in some situations. The lead vehicle graphic does not illuminate if the system does not detect a vehicle in front of you.

Cruise Control

A

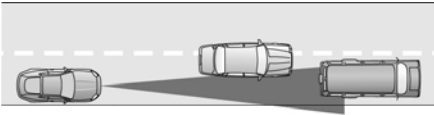

B

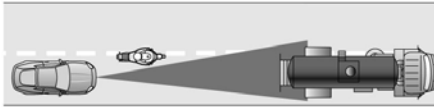

C

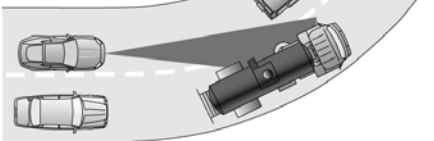

E71621

Detection issues can occur:

- When driving on a different line than the vehicle in front.
- With vehicles that edge into your lane. The system can only detect these vehicles once they move fully into your lane.
- There may be issues with the detection of vehicles in front when driving into and coming out of a bend or curve in the road.

In these cases, the system may brake late or unexpectedly. You should stay alert and take action when necessary.

If something hits the front end of your vehicle or damage occurs, the radar-sensing zone may change. This could cause missed or false vehicle detection.

System Not Available

The system may not turn on if there is:

- A blocked sensor.
- High brake temperature.
- A failure in the system or a related system.

Blocked Sensor



E145632

Note: You cannot see the sensor. It is behind a fascia panel.

A message displays if something obstructs the radar signals from the sensor. The sensor is in the lower grille. The system cannot detect a vehicle ahead and does not function when something blocks the sensor.

Cruise Control

Possible Causes and Actions for This Message Displaying:

Cause	Action
The surface of the radar is dirty or obstructed.	Clean the grille surface in front of the radar or remove the object causing the obstruction.
The surface of the radar is clean but the message remains in the display.	Wait a short time. It may take several minutes for the radar to detect that it is free from obstruction.
Heavy rain or snow is interfering with the radar signals.	Do not use the system in these conditions because it may not detect any vehicles ahead.
Water, snow or ice on the surface of the road may interfere with the radar signals.	Do not use the system in these conditions because it may not detect any vehicles ahead.

Due to the nature of radar technology, it is possible to get a blockage warning with no actual block. This happens, for example, when driving in sparse rural or desert environments. A false blocked condition either self clears, or clears after you restart your vehicle.

Switching to Normal Cruise Control

WARNING



Normal cruise control will not brake when your vehicle is approaching slower vehicles. Always be aware of which mode you have selected and apply the brakes when necessary.

You can manually change from adaptive cruise control to normal cruise control through the information display.



The cruise control indicator light replaces the adaptive cruise control indicator light if you select normal cruise control. The gap setting does not display, and the system does not automatically respond to lead vehicles. Automatic braking remains active to maintain set speed.

Driving Aids

BLIND SPOT INFORMATION SYSTEM (If Equipped)

WARNING



To help avoid injuries, NEVER use the Blind Spot Information System as a replacement for using the interior and exterior mirrors or looking over your shoulder before changing lanes. The Blind Spot Information System is not a replacement for careful driving.

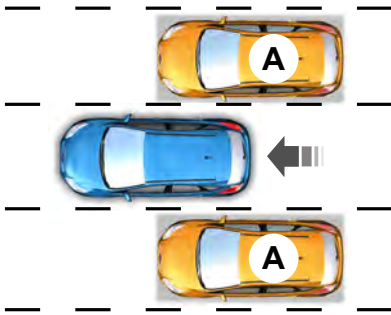

E124788

The Blind Spot Information System is designed to aid you in detecting vehicles that may have entered the blind spot zone (A). The detection area is on both sides of your vehicle, extending rearward from the exterior mirrors to approximately 13 ft (4 m) beyond the bumper. The system is designed to alert you if certain vehicles enter the blind spot zone while driving.

Note: The Blind Spot Information System does not prevent contact with other vehicles or objects; nor detect parked vehicles, people, animals or infrastructure (fences, guardrails, trees). It's only designed to alert you to vehicles in the blind spot zones.

Note: When a vehicle passes quickly through the blind spot zone, typically fewer than two seconds, the system does not trigger.

Using the System

The Blind Spot Information System turns on when you start the engine and you drive your vehicle forward above 5 mph (8 km/h).

For automatic transmissions, the Blind Spot Information System remains on while the transmission is in drive (D). If shifted into reverse (R) or park (P) the Blind Spot Information System turns off. Once shifted back into drive (D), the Blind Spot Information System turns back on when you drive your vehicle above 5 mph (8 km/h).

For manual transmissions, the Blind Spot Information System is on for all gears except the reverse (R).

Note: The Blind Spot Information System does not function in reverse (R) or park (P).

System Lights and Messages



E142442

Driving Aids

The Blind Spot Information System illuminates an amber alert indicator in the outside mirror on the side of your vehicle the approaching vehicle is coming from. When the Blind Spot Information System is alerting on a vehicle and the corresponding turn signal is ON, the Blind Spot Information System alert indicator flashes as an increased warning level.

The alert indicator dims when the system detects nighttime darkness.

Note: *The alert indicator flashes in case of an alert and the turn signal is set to that side at the same time.*

System Sensor Blockage

WARNING



To help avoid injuries, NEVER use the Blind Spot Information System as a replacement for using the interior and exterior mirrors or looking over your shoulder before changing lanes. The Blind Spot Information System is not a replacement for careful driving.

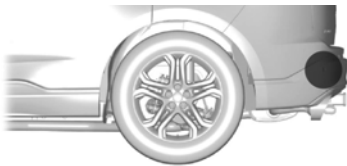

E205199

The system uses radar sensors that are located behind the bumper fascia on each side of your vehicle. Any dirt, mud and snow in front of the sensors and/or driving in heavy rain can cause system degradation. Also, other types of obstructions in front of the sensor can cause system degradation. This is referred to as a 'blocked' condition.

Note: *Do not apply bumper stickers and/or repair compound to these areas, this can cause degraded system performance.*

If the system detects a degraded performance condition, a message warning of a blocked sensor will appear in the information display. Also the BLIS alert indicators will remain ON and BLIS will no longer provide any vehicle warnings. You can clear the information display warning but the alert indicators will remain illuminated.

A "blocked" condition can be cleared in two ways:

- After the blockage in front of the sensors is removed or the rainfall/snowfall rate decreases or stops, drive for a few minutes in traffic to allow the sensors to detect passing vehicles.
- By cycling the ignition from ON to OFF and then back ON.

Note: *If your vehicle has a tow bar with a factory equipped trailer tow module and it is towing a trailer, the sensors will automatically turn the Blind Spot Information System off. If your vehicle has a tow bar but no factory equipped trailer tow module, it is recommended to turn the Blind Spot Information System off manually. Operating the Blind Spot Information System with a trailer attached will cause poor system performance.*

System Errors

If the system senses a problem with the left or right sensor, the telltale will illuminate and a message will appear in the information display. See **Information Messages** (page 91).

Driving Aids

Switching the System Off and On

You can temporarily switch the Blind Spot Information System off in the information display. See **General Information** (page 83). When the Blind Spot Information System switches off, you will not receive alerts and the information display shows a system off message. The telltale in the cluster also illuminates. When you switch the Blind Spot Information System on or off, the alert indicators flash twice.

Note: *The Blind Spot Information System remembers the last selected on or off setting.*

You can also have the Blind Spot Information System switched off permanently at an authorized dealer. Once switched off permanently, the system can only be switched back on at an authorized dealer.

CROSS TRAFFIC ALERT (If

Equipped)

WARNING



To help avoid personal injury, NEVER use the Cross Traffic Alert system as a replacement for using the interior and exterior mirrors and looking over your shoulder before backing out of a parking space. Cross Traffic Alert is not a replacement for careful driving.

Cross Traffic Alert is designed to warn you of vehicles approaching from the sides when the transmission is in reverse (R).

Using the System

Cross Traffic Alert turns on when you start the engine and you shift into reverse (R). Once shifted out of reverse (R), Cross Traffic Alert turns off.

Note: *Cross Traffic Alert only functions while your transmission is in reverse (R).*

Cross Traffic Alert is designed to detect vehicles that approach with a speed up to 37 mph (60 km/h). Coverage decreases when the sensors are partially, mostly or fully obstructed. Reversing slowly helps increase the coverage area and effectiveness.

Driving Aids

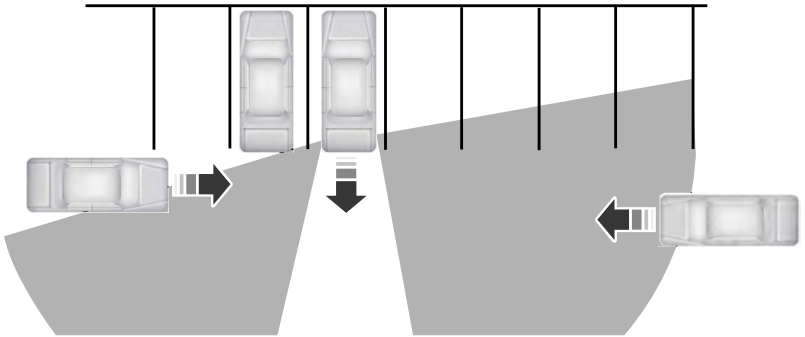

E142440

In this first example, the left sensor is only partially obstructed; zone coverage to the right is nearly maximized.

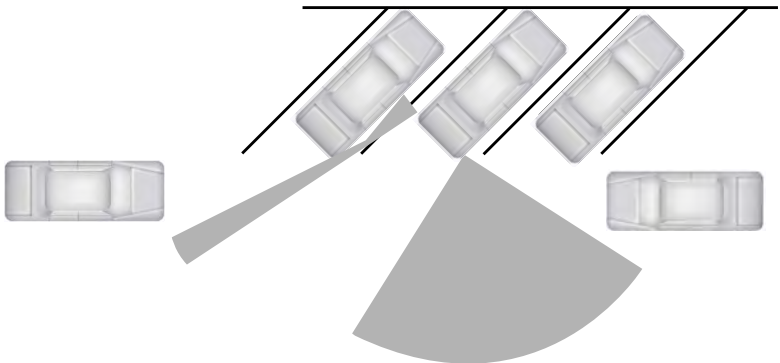

E142441

Driving Aids

Zone coverage also decreases when parking at shallow angles. Here, the left sensor is mostly obstructed; zone coverage on that side is severely limited.

System Lights, Messages and Audible Alerts



E142442

The Cross Traffic Alert illuminates an amber alert indicator in the outside mirror on the side of your vehicle the approaching vehicle is coming from. Cross Traffic Alert also sounds an audible alert and a message appears in the information display indicating a vehicle is coming from the right or left. Cross Traffic Alert works with the reverse sensing system that sounds its own series of tones. See **Rear Parking Aid** (page 150).



E205199

The system uses radar sensors that are located behind the bumper fascia on each side of your vehicle. Do not allow mud, snow or bumper stickers to obstruct these areas, this can cause degraded system performance. See **Blind Spot**

Information System (page 162). If the Blind Spot Information System is blocked, Cross Traffic Alert is also blocked. A corresponding message appears in the information display as soon as you shift the transmission into reverse (R).

System Limitations

Cross Traffic Alert has its limitations; situations such as severe weather conditions or debris build-up on the sensor area may limit vehicle detection.

The following are other situations that may limit the Cross Traffic Alert performance:

- Adjacently parked vehicles or objects obstructing the sensors.
- Approaching vehicles passing at speeds greater than 37 mph (60 km/h).
- Driving in reverse faster than 7 mph (12 km/h).
- Backing out of an angled parking spot.

False Alerts

Note: *If your vehicle has a tow bar with a factory equipped trailer tow module and it is towing a trailer, the sensors will automatically turn the Cross Traffic Alert off. If your vehicle has a tow bar but no factory equipped trailer tow module, it is recommended to turn the Cross Traffic Alert off manually. Operating Cross Traffic Alert with a trailer attached will cause poor Cross Traffic Alert performance.*

There may be certain instances when there is a false alert by the Cross Traffic Alert system that illuminates the alert indicator with no vehicle in the coverage zone. Some amount of false alerts are normal; they are temporary and self-correct.

Driving Aids

System Errors

If Cross Traffic Alert senses a problem with the left or right sensor a message will appear in the information display. See **General Information** (page 83).

Switching the System Off and On

You can temporarily switch Cross Traffic Alert off in the information display. See **General Information** (page 83). When you switch Cross Traffic Alert off, you will not receive alerts and the information display will display a system off message.

Note: *The Cross Traffic Alert switches on whenever the ignition is switched on and ready to provide appropriate alerts when the transmission is in reverse (R). Cross Traffic Alert will not remember the last selected on or off setting.*

You can also have Cross Traffic Alert switched off permanently at an authorized dealer. Once switched off permanently, the system can only be switched back on at an authorized dealer.

STEERING

Electric Power Steering

WARNINGS



The electric power steering system has diagnostic checks that continuously monitor the system. If a fault is detected, a message displays in the information display. Stop your vehicle as soon as it is safe to do so. Switch the ignition off. After at least 10 seconds, switch the ignition on and watch the information display for a steering system warning message. If a steering system warning message returns, have the system checked by an authorized dealer.

WARNINGS



If the system detects an error, you may not feel a difference in the steering, however a serious condition may exist. Obtain immediate service from an authorized dealer, failure to do so may result in loss of steering control.

Your vehicle has an electric power steering system. There is no fluid reservoir. No maintenance is required.

If your vehicle loses electrical power while you are driving, electric power steering assistance is lost. The steering system still operates and you can steer your vehicle manually. Manually steering your vehicle requires more effort.

Extreme continuous steering may increase the effort required for you to steer your vehicle. This increased effort prevents overheating and permanent damage to the steering system. You do not lose the ability to steer your vehicle manually. Typical steering and driving maneuvers allow the system to cool and return to normal operation.

Steering Tips

If the steering wanders or pulls, check for:

- Correct tire pressures.
- Uneven tire wear.
- Loose or worn suspension components.
- Loose or worn steering components.
- Improper vehicle alignment.

Note: *A high crown in the road or high crosswinds may also make the steering seem to wander or pull.*

Driving Aids

Adaptive Learning

The electronic power steering system adaptive learning helps correct road irregularities and improves overall handling and steering feel. It communicates with the brake system to help operate advanced stability control and accident avoidance systems. Additionally, whenever the battery is disconnected or a new battery installed, you must drive your vehicle a short distance before the system relearns the strategy and reactivates all systems.

COLLISION WARNING SYSTEM

(If Equipped)

PRINCIPLE OF OPERATION

WARNINGS



This system is designed to be a supplementary driving aid. It is not intended to replace the driver's attention, and judgment, or the need to apply the brakes. This system does NOT activate the brakes automatically. Failure to press the brake pedal to activate the brakes may result in a collision.



The collision warning system with brake support cannot help prevent all collisions. Do not rely on this system to replace driver judgment and the need to maintain distance and speed.

Note: The system does not detect, warn or respond to potential collisions with vehicles to the rear or sides of the vehicle.

Note: The collision warning system is active at speeds above approximately 5 mph (8 km/h).

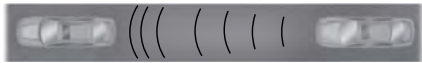

E156130

This system is designed to alert the driver of certain collision risks. A radar detects if your vehicle is rapidly approaching another vehicle traveling in the same direction as yours.

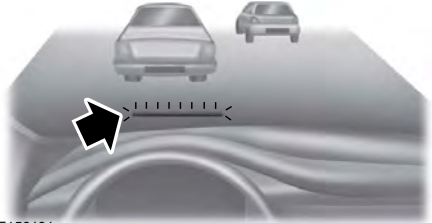

E156131

If it is, a red warning light illuminates and an audible warning chime sounds.

The brake support system assists the driver in reducing the collision speed by charging the brakes. If the risk of collision further increases after the warning light illuminates, the brake support prepares the brake system for rapid braking. This may be apparent to the driver. The system does not automatically activate the brakes but, if the brake pedal is pressed, full force braking is applied even if the brake pedal is lightly pressed.

Using the Collision Warning System

WARNING



The collision warning system's brake support can only help reduce the speed at which a collision occurs if the driver applies the vehicle's brakes. The brake pedal must be pressed just like any typical braking situation.

The warning system sensitivity can be adjusted to one of three possible settings by using the information display control. See **General Information** (page 83).

Driving Aids

Note: If collision warnings are perceived as being too frequent or disturbing then the warning sensitivity can be reduced, though the manufacturer recommends using the highest sensitivity setting where possible. Setting lower sensitivity would lead to fewer and later system warnings. See **General Information** (page 83).

Blocked Sensors



E145632

If a message regarding a blocked sensor appears in the information display, the radar signals from the sensor have been obstructed. The sensors are located behind a fascia cover near the driver side of the lower grille. When the sensors are obstructed, a vehicle ahead cannot be detected and the collision warning system does not function. The following table lists possible causes and actions for this message being displayed.

Cause	Action
The surface of the radar in the grille is dirty or obstructed in some way	Clean the grille surface in front of the radar or remove the object causing the obstruction
The surface of the radar in the grille is clean but the message remains in the display	Wait a short time. It may take several minutes for the radar to detect that it is no longer obstructed
Heavy rain, spray, snow, or fog is interfering with the radar signals	The collision warning system is temporarily disabled. Collision warning should automatically reactivate a short time after the weather conditions improve
Swirling water, or snow or ice on the surface of the road may interfere with the radar signals	The collision warning system is temporarily disabled. Collision warning should automatically reactivate a short time after the weather conditions improve

Driving Aids

System Limitations

WARNING



The collision warning system's brake support can only help reduce the speed at which a collision occurs if the driver applies the vehicle's brakes. The brake pedal must be pressed just like any typical braking situation.

Due to the nature of radar technology, there may be certain instances where vehicles do not provide a collision warning. These include:

- Stationary vehicles or vehicles moving below 6 mph (10 km/h).
- Pedestrians or objects in the roadway.
- Oncoming vehicles in the same lane.
- Severe weather conditions (see blocked sensor section).
- Debris build-up on the grille near the headlamps (see blocked sensor section).
- Small distance to vehicle ahead.
- Steering wheel and pedal movements are large (very active driving style).

If the front end of the vehicle is hit or damaged, the radar sensing zone may be altered causing missed or false collision warnings. See your authorized dealer to have your collision warning radar checked for proper coverage and operation.

DRIVE CONTROL

Selectable Drive Modes

Selectable drive modes delivers a driving experience through a suite of sophisticated electronic vehicle systems. These systems optimize steering, handling and powertrain response. This provides a single location to control multiple systems performance settings.

Selectable drive modes consists of the following systems:

- Electronically power-assisted steering adjusts steering effort and feel based on your selected mode.
- Electronic stability control and traction control maintain your vehicle control in adverse conditions or high performance driving. See **Stability Control** (page 146).
- Electronic throttle control enhances the powertrain response to your inputs.

Using Selectable Drive Modes

Selectable drive modes automatically tailors your vehicle configuration for each mode selected.



To change the drive mode setting, toggle the mode button or switch on the instrument panel under the display. The first press of the mode button or switch illuminates the selected mode, subsequent presses will change the selected mode.

Note: Mode changes are not available when the vehicle ignition is off or reverse (R) gear is selected. In gear position drive (D), the available modes are Normal, Sport+, Track and Snow/Wet. In gear position sport (S) Snow/Wet and Normal mode are unavailable.

Driving Aids

Modes:

- Normal – Delivers a balanced combination of comfort and handling. This mode provides an engaging drive experience and a direct connection to the road without sacrificing any of the composure demanded from your vehicle.
- Sport – Engages when you shift your automatic transmission into sport (S). Sport mode increases throttle response and helps your vehicle accelerate faster, but does not change the feel of the steering or stability system.
- Sport+ – Provides a sportier steering feel and throttle response. Sport+ mode is ideal for use during more spirited driving.
- Track – Provides a performance driving experience. The engine responds directly to your inputs and takes on a more powerful tone. Track mode is for use when pure performance is desired. A performance oriented traction control mode is automatically utilized when Track drive mode is selected. In this mode, traction control intervention is reduced and tuned specifically for track usage only and is not intended for public roads. See **Using Stability Control** (page 147).
- Snow/Wet - Provides a confident handling driving experience during poor weather. This mode provides a confident drive experience and a direct connection to the road without sacrificing any of the composure demanded from your vehicle.

Note: Selectable driving modes has diagnostic checks that continuously monitor the system to ensure proper operation. Certain selectable drive modes will not be available based on gear shifter position (for example, Snow/Wet is not available while in sport (S) position). If a selected mode is unavailable due to a system fault or change in gear shifter position, the selected mode will default to Normal.

Note: Collision warning with brake support is automatically disabled when Track mode is selected.

Selectable Steering

Note: The steering setting defaults to Normal if the battery is disconnected or removed.



To change the steering feel, toggle the switch on the instrument panel. The first press illuminates the selected mode, subsequent presses will change the selected mode.

Modes:

- Normal - Default factory setting.
- Sport - Slightly higher effort required for steering with more road force felt through the steering wheel.
- Comfort - Slightly less effort required for steering with less road force felt through the steering wheel.

After selecting the desired setting, you may feel a soft feedback bump in the steering wheel when the changeover occurs.

Note: If your vehicle is equipped with the selectable drive modes feature, the steering feel will change when you select a new drive mode. You can override this automatic selection by pressing the steering button or switch.

Load Carrying

LOAD LIMIT

Vehicle Loading - with and without a Trailer

This section guides you in the proper loading of your vehicle, trailer, or both. Keep your loaded vehicle weight within its design rating capability, with or without a trailer. Properly loading your vehicle provides maximum return of vehicle design performance. Before you load your vehicle, become familiar with the following terms for determining your vehicle's weight rating, with or without a trailer, from the vehicle's Tire and Loading Information label or Safety Compliance Certification label.

Tire and Loading Label Information Example:

TIRE AND LOADING INFORMATION

SEATING CAPACITY TOTAL: 5 FRONT: 2 REAR: 3

The combined weight of occupants and cargo should never exceed: **385 kg or 850 lbs.**

TIRE	SIZE	COLD TIRE PRESSURE
FRONT	235/45R18 94V	235 KPA, 34 PSI
REAR	235/45R18 94V	235 KPA, 34 PSI
SPARE	NONE	NONE

SEE OWNERS MANUAL FOR ADDITIONAL INFORMATION

TIRE AND LOADING INFORMATION
RENSEIGNEMENTS SUR LES PNEUS ET LE CHARGEMENT

SEATING CAPACITY / NOMBRE DE PLACES TOTAL 5 FRONT AVANT 2 REAR ARRIERE 3

The combined weight of occupants and cargo should never exceed 396 kg or 875 lbs.
Le poids total des occupants et du chargement ne doit jamais dépasser 396 kg ou 875 lb.

TIRE / PNEU	SIZE / DIMENSIONS	COLD TIRE PRESSURE / PRESSION DES PNEUS A FROID
FRONT AVANT	235/40R19 96V	255 KPA, 37 PSI
REAR ARRIERE	235/40R19 96V	255 KPA, 37 PSI
SPARE DE SECOURS	T125/80R16 97M	415 KPA, 60 PSI

SEE OWNER'S MANUAL FOR ADDITIONAL INFORMATION
VOIR LE MANUEL DE L'USAGER POUR PLUS DE RENSEIGNEMENTS

E198719

Payload

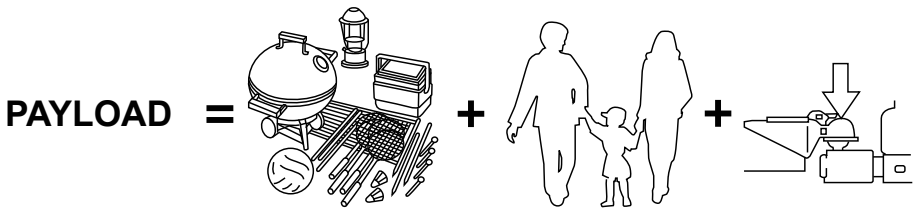

E143816

Load Carrying

Payload is the combined weight of cargo and passengers that your vehicle is carrying. The maximum payload for your vehicle appears on the Tire and Loading label. The label is either on the B-pillar or the edge of the driver door. Vehicles exported outside the US and Canada may not have a tire and loading label. Look for “The combined weight of occupants and cargo should never exceed XXX kg OR XXX lb” for maximum payload. The payload listed on the Tire and Loading Information label is the maximum payload for your vehicle as built by the assembly plant. If you install any additional equipment on your vehicle, you must determine the new payload. Subtract the weight of the equipment from the payload listed on the Tire and Loading label. When towing, trailer tongue weight or king pin weight is also part of payload.

WARNING



The appropriate loading capacity of your vehicle can be limited either by volume capacity (how much space is available) or by payload capacity (how much weight the vehicle should carry). Once you have reached the maximum payload of your vehicle, do not add more cargo, even if there is space available. Overloading or improperly loading your vehicle can contribute to loss of vehicle control and vehicle rollover.

GAWR (Gross Axle Weight Rating)

GAWR is the maximum allowable weight that a single axle (front or rear) can carry. These numbers are on the Safety Compliance Certification label. The label is located on the door hinge pillar, door-latch post, or the door edge that meets the door-latch post, next to the driver seating position.

The total load on each axle must never exceed its Gross Axle Weight Rating.

GVWR (Gross Vehicle Weight Rating)

GVWR is the maximum allowable weight of the fully loaded vehicle. This includes all options, equipment, passengers and cargo. It appears on the Safety Compliance Certification label. The label is located on the door hinge pillar, door-latch post, or the door edge that meets the door-latch post, next to the driver seating position.

The gross vehicle weight must never exceed the Gross Vehicle Weight Rating.

Load Carrying

Safety Compliance Certification Label Example:

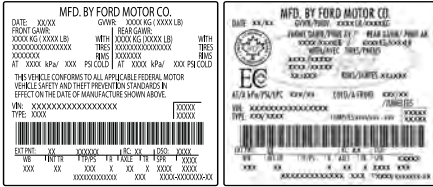

6198828

WARNING



Exceeding the Safety Compliance Certification label vehicle weight rating limits could result in substandard vehicle handling or performance, engine, transmission and/or structural damage, serious damage to the vehicle, loss of control and personal injury.

Maximum Loaded Trailer Weight

Maximum loaded trailer weight is the highest possible weight of a fully loaded trailer the vehicle can tow. Consult an authorized dealer (or the RV and Trailer Towing Guide available at an authorized dealer) for more detailed information.

GCWR (Gross Combined Weight Rating)

GCWR is the maximum allowable weight of the vehicle and the loaded trailer, including all cargo and passengers, that the vehicle can handle without risking damage. (Important: The towing

vehicle's braking system is rated for operation at Gross Vehicle Weight Rating, not at Gross Combined Weight Rating.) Separate functional brakes should be used for safe control of towed vehicles and for trailers where the Gross Combined Weight of the towing vehicle plus the trailer exceed the Gross Vehicle Weight Rating of the towing vehicle.

The gross combined weight must never exceed the Gross Combined Weight Rating.

Note: For trailer towing information refer to the *RV and Trailer Towing Guide* available at an authorized dealer.

WARNINGS



Do not exceed the GVWR or the GAWR specified on the Safety Compliance Certification label.



Do not use replacement tires with lower load carrying capacities than the original tires because they may lower your vehicle's GVWR and GAWR limitations. Replacement tires with a higher limit than the original tires do not increase the GVWR and GAWR limitations.



Exceeding any vehicle weight rating limitation could result in serious damage to your vehicle, personal injury or both.

Load Carrying

Steps for determining the correct load limit:

1. Locate the statement "The combined weight of occupants and cargo should never exceed XXX kg or XXX lb." on your vehicle's placard.
2. Determine the combined weight of the driver and passengers that will be riding in your vehicle.
3. Subtract the combined weight of the driver and passengers from XXX kg or XXX lb.
4. The resulting figure equals the available amount of cargo and luggage load capacity. For example, if the "XXX" amount equals 1,400 lb. and there will be five 150 lb. passengers in your vehicle, the amount of available cargo and luggage load capacity is 650 lb. $(1400 - 750 (5 \times 150) = 650 \text{ lb.})$
5. Determine the combined weight of luggage and cargo being loaded on the vehicle. That weight may not safely exceed the available cargo and luggage load capacity calculated in Step 4.
6. If your vehicle will be towing a trailer, load from your trailer will be transferred to your vehicle. Consult this manual to determine how this reduces the available cargo and luggage load capacity of your vehicle.

Helpful examples for calculating the available amount of cargo and luggage load capacity

Suppose your vehicle has a 1400-pound (635-kilogram) cargo and luggage capacity. You decide to go golfing. Is there enough load capacity to carry you, four of your friends and all the golf bags? You and four friends average 220 pounds (99 kilograms) each and the golf bags weigh approximately 30 pounds (13.5 kilograms) each. The calculation would be: $1400 - (5 \times 220) - (5 \times 30) = 1400 - 1100 - 150 = 150$ pounds. Yes, you have enough load capacity in your vehicle to transport four friends and your golf bags. In metric units, the calculation would be: $635 \text{ kilograms} - (5 \times 99 \text{ kilograms}) - (5 \times 13.5 \text{ kilograms}) = 635 - 495 - 67.5 = 72.5$ kilograms.

Suppose your vehicle has a 1400-pound (635-kilogram) cargo and luggage capacity. You and one of your friends decide to pick up cement from the local home improvement store to finish that patio you have been planning for the past two years. Measuring the inside of the vehicle with the rear seat folded down, you have room for twelve 100-pound (45-kilogram) bags of cement. Do you have enough load capacity to transport the cement to your home? If you and your friend each weigh 220 pounds (99 kilograms), the calculation would be: $1400 - (2 \times 220) - (12 \times 100) = 1400 - 440$

Load Carrying

- 1200 = - 240 pounds. No, you do not have enough cargo capacity to carry that much weight. In metric units, the calculation would be: 635 kilograms - (2 x 99 kilograms) - (12 x 45 kilograms) = 635 - 198 - 540 = -103 kilograms. You will need to reduce the load weight by at least 240 pounds (104 kilograms). If you remove three 100-pound (45-kilogram) cement bags, then the load calculation would be: 1400 - (2 x 220) - (9 x 100) = 1400 - 440 - 900 = 60 pounds. Now you have the load capacity to transport the cement and your friend home. In metric units, the calculation would be: 635 kilograms - (2 x 99 kilograms) - (9 x 45 kilograms) = 635 - 198 - 405 = 32 kilograms.

The above calculations also assume that the loads are positioned in your vehicle in a manner that does not overload the front or the rear gross axle weight rating specified for your vehicle on the Safety Compliance Certification label.

Special Loading Instructions for Owners of Pick-up Trucks and Utility-type Vehicles

WARNING



Loaded vehicles may handle differently than unloaded vehicles. Take extra precautions, such as slower speeds and increased stopping distance, when driving a heavily loaded vehicle.

Towing

TOWING A TRAILER

WARNINGS



Do not exceed the GVWR or the GAWR specified on the certification label.



Towing trailers beyond the maximum recommended gross trailer weight exceeds the limit of your vehicle and could result in engine damage, transmission damage, structural damage, loss of vehicle control, vehicle rollover and personal injury.

Note: *There may be electrical items such as fuses or relays that can affect trailer towing operation. See **Fuses** (page 201).*

The load capacity of your vehicle is designated by weight not volume. You may not necessarily be able to use all available space when loading your vehicle or trailer.

Towing a trailer places extra load on the engine, transmission, axle, brakes, tires, and suspension. Inspect these components before, during and after towing.

Load Placement

To help minimize how trailer movement affects the vehicle when driving:

- Load the heaviest items closest to the trailer floor.
- Load the heaviest items in the center of the left and right side trailer tires.
- Load the heaviest items above the trailer axles or just slightly forward toward the trailer tongue. Do not allow the final trailer tongue weight to go above or below 10-15% of the loaded trailer weight.
- Select a ball mount with the correct rise or drop. When both the loaded vehicle and trailer are connected, the trailer frame should be level, or slightly angled down toward the vehicle, when viewed from the side.

When driving with a trailer or payload, a slight takeoff vibration or shudder may be present due to the increased payload weight. Additional information regarding proper trailer loading and setting your vehicle up for towing is located in the Load Carrying chapter. See **Load Limit** (page 172).

You can also find information in the **RV & Trailer Towing Guide** available at your authorized dealer, or online.

Towing

RV & Trailer Towing Guide Online

Website | <http://www.fleet.ford.com/towing-guides/>

RECOMMENDED TOWING WEIGHTS

Note: Do not exceed the trailer weight for your vehicle configuration listed in the chart below.

Note: Be sure to take into consideration trailer frontal area. Do not exceed 20 feet² (1.86 meters²).

Note: For high altitude operation, reduce the gross combined weight by 2% per 1000 feet (300 meters) starting at the 1000 foot (300 meter) elevation point.

Note: Certain states require separate trailer brakes for trailers over a specified weight. Be sure to check state regulations for this specified weight. The maximum trailer weights listed may be limited to this specified weight, as the vehicle's electrical system may not include the wiring connector needed to activate electric trailer brakes.

Your vehicle may tow a trailer provided the maximum trailer weight is less than or equal to the maximum trailer weight listed for your vehicle configuration on the following chart.

Powertrain	Maximum trailer weight
2.3L GTDI	1000 lb (454 kg)
3.7L TiVCT	1000 lb (454 kg)
5.0L TiVCT	1000 lb (454 kg)

Towing

ESSENTIAL TOWING CHECKS

Follow these guidelines for safe towing:

- Do not tow a trailer until you drive your vehicle at least 1000 miles (1600 kilometers).
- Consult your local motor vehicle laws for towing a trailer.
- See the instructions included with towing accessories for the proper installation and adjustment specifications.
- Service your vehicle more frequently if you tow a trailer. See your scheduled maintenance information.
- If you use a rental trailer, follow the instructions the rental agency gives you.

You can find information on load specification terms found on the tire label and Safety Compliance label as well as instructions on calculating your vehicle's load in the Load Carrying chapter. See **Load Limit** (page 172).

Remember to account for the trailer tongue weight as part of your vehicle load when calculating the total vehicle weight.

Hitches

Do not use a hitch that either clamps onto the bumper or attaches to the axle.

Distribute the trailer load so 10-15% of the total trailer weight is on the tongue.

Safety Chains

Note: *Never attach safety chains to the bumper.*

Always connect the safety chains to the hook retainers of your vehicle hitch.

To connect the safety chains, cross them under the trailer tongue and allow enough slack for turning tight corners. Do not allow the chains to drag on the ground.

Trailer Brakes

WARNING



Do not connect a trailer's hydraulic brake system directly to your vehicle's brake system. Your vehicle may not have enough braking power and your chances of having a collision greatly increase.

Electric brakes and manual, automatic or surge-type trailer brakes are safe if you install them properly and adjust them to the manufacturer's specifications. The trailer brakes must meet local and federal regulations.

The rating for the tow vehicle's braking system operation is at the gross vehicle weight rating, not the gross combined weight rating.

Trailer Lamps

WARNING



Never connect any trailer lamp wiring to the vehicle's tail lamp wiring; this may damage the electrical system resulting in fire. Contact your authorized dealer as soon as possible for assistance in proper trailer tow wiring installation. Additional electrical equipment may be required.

Trailer lamps are required on most towed vehicles. Make sure all running lights, brake lights, direction indicators and hazard lights are working.

Before Towing a Trailer

Practice turning, stopping and backing up to get the feel of your vehicle-trailer combination before starting on a trip. When turning, make wider turns so the trailer wheels clear curbs and other obstacles.

Towing

When Towing a Trailer

- Do not drive faster than 70 mph (113 km/h) during the first 500 miles (800 kilometers).
- Do not make full-throttle starts.
- Check your hitch, electrical connections and trailer wheel lug nuts thoroughly after you have traveled 50 miles (80 kilometers).
- When stopped in congested or heavy traffic during hot weather, place the gearshift in park (P) (automatic transmission) or neutral (manual transmission) to aid engine and transmission cooling and to help air conditioning performance.
- Switch off the speed control with heavy loads or in hilly terrain. The speed control may turn off automatically when you are towing on long, steep grades.
- Shift to a lower gear when driving down a long or steep hill. Do not apply the brakes continuously, as they may overheat and become less effective.
- If your transmission is equipped with a Grade Assist or Tow/Haul feature, use this feature when towing. This provides engine braking and helps eliminate excessive transmission shifting for optimum fuel economy and transmission cooling.
- Allow more distance for stopping with a trailer attached. Anticipate stops and brake gradually.
- Avoid parking on a grade. However, if you must park on a grade:
 1. Turn the steering wheel to point your vehicle tires away from traffic flow.
 2. Set your vehicle parking brake.
 3. Place the automatic transmission in park (P) or manual transmission in a low gear.

4. Place wheel chocks in front and back of the trailer wheels. (Chocks not included with vehicle.)

Launching or Retrieving a Boat or Personal Watercraft (PWC)

Note: *Disconnect the wiring to the trailer before backing the trailer into the water.*

Note: *Reconnect the wiring to the trailer after removing the trailer from the water.*

When backing down a ramp during boat launching or retrieval:

- Do not allow the static water level to rise above the bottom edge of the rear bumper.
- Do not allow waves to break higher than 6 inches (15 centimeters) above the bottom edge of the rear bumper.

Exceeding these limits may allow water to enter vehicle components:

- Causing internal damage to the components.
- Affecting driveability, emissions, and reliability.

Any time the rear axle submerges in water, replace the rear axle lubricant. Water may contaminate the rear axle lubricant, which is not a normal maintenance inspection item unless there is a possibility of a leak or other axle repair is required.

TOWING THE VEHICLE ON FOUR WHEELS

Emergency Towing

WARNING



If your vehicle has a steering wheel lock make sure the ignition is in the accessory or on position when being towed.

Towing

You can flat-tow (all wheels on the ground, regardless of the powertrain or transmission configuration) your disabled vehicle (without access to wheel dollies or vehicle transport trailer) under the following conditions:

- Your vehicle is facing forward so you tow it in a forward direction.
- You shift into Neutral (N). If you cannot shift into Neutral (N), you may need to override the transmission. See **Transmission** (page 136).
- Maximum speed is 35 mph (56 km/h).
- Maximum distance is 50 mi (80 km).

Recreational Towing

Note: *Put your climate control system in recirculated air mode to prevent exhaust fumes from entering the vehicle. See **Climate Control** (page 102).*

Follow these guidelines if you have a need for recreational (RV) towing. An example of recreational towing would be towing your vehicle behind a motorhome. These guidelines are to make sure you do not damage the transmission during towing.

Do not tow your vehicle with any wheels on the ground, as vehicle or transmission damage may occur. It is recommended to tow your vehicle with all four wheels off the ground, for example when using a vehicle transport trailer. Otherwise, you cannot tow your vehicle.

Convertible Top (If Equipped)

OPENING THE CONVERTIBLE TOP

When you use the top, you must first unlatch it from the windshield and then use the convertible top control.

Note: *The convertible top does not operate unless the vehicle is stationary or traveling under 3 mph (5 km/h). A chime sounds and a warning message appears in the instrument panel when you slow down, the top operates.*

Note: *When you latch or unlatch the convertible top, the audio system mutes briefly. This allows the vehicle to optimize the cabin's sound quality depending on the position of the convertible top.*

To unlatch the convertible top:

1. Bring the vehicle to a complete stop. The ignition must be on. We recommend that the vehicle remains running when you open the top to prevent draining the battery.
2. Check the convertible top stowage compartment behind the rear seat to be sure it is empty. Make sure the convertible top outer surface is free of debris.
3. Move the latch handle, above the interior mirror, down toward the windshield and rotate the handle clockwise to release the convertible top.



E174571

The windows open automatically when you press the convertible top control.

To open the convertible top:

1. Press and hold the convertible top control on the overhead console, until the windows are completely down and the top stores completely.
2. Release the convertible top control.



E174568

Note: *Do not store articles behind the rear seat. Articles in the convertible top stowage compartment may break the rear glass window when you open the top.*

Note: *Opening the convertible top when the top material is wet may cause mold or mildew.*

Convertible Top (If Equipped)

Using the Tonneau Caps

Your convertible top also includes two tonneau caps, one for each side of the vehicle. These caps stow inside the trunk.

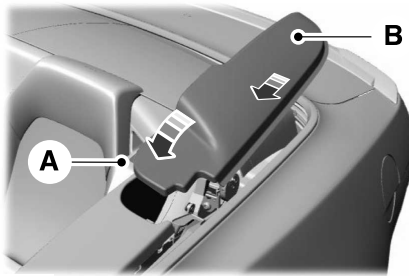

E205441

A.	Leading edge.
B.	Side edge.

After opening your convertible top, place the tonneau caps between the top and your vehicle trim moulding:

1. Insert tab A under the trim.
2. When tab A is under the trim slot, angle B down so the edges slide under the surrounding moulding and secure into place between the trim edges.
3. Repeat Steps 1 and 2 on the opposite side of the vehicle to install the second tonneau cap.

CLOSING THE CONVERTIBLE TOP

Closing the convertible top is a three-step process: Remove both of the tonneau caps, press the convertible top control to close the top, and then close the latch.

To remove the tonneau caps:

1. Slide B toward the center of the vehicle to release the edges from the surrounding trim.
2. Lift up on B, and then pull the piece back to release tab A from the trim.
3. Repeat Steps 1 and 2 on the opposite side of the vehicle.
4. Make sure you stow both pieces in the trunk.

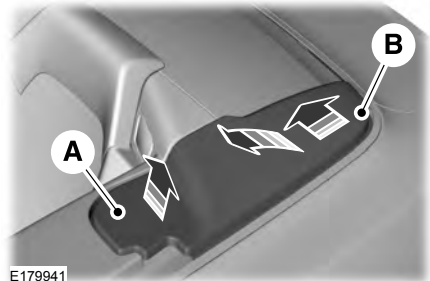

E179941

Note: The convertible top does not operate unless the vehicle is stationary or traveling under 3 mph (5 km/h). A chime sounds and a warning message appears in the instrument panel. When you slow down, the top operates.

Note: You must remove the tonneau caps before you are able to close the top or a chime sounds and a warning message appears in the instrument panel. Remove and stow the caps in the trunk, and then press the convertible top control again.

Note: When you latch or unlatch the convertible top, the audio system mutes briefly. This allows the vehicle to optimize the cabin's sound quality depending on the position of the convertible top.

Convertible Top (If Equipped)

To close the convertible top:

1. Bring the vehicle to a complete stop and make sure you switch the ignition on. We recommend that the vehicle remains running when you open the top to prevent draining the battery.
2. Press and hold the convertible top control. When the convertible latch handle is within reach, make sure it is down and that you rotate it clockwise so the latch is in the fully opened position. Continue pressing the convertible top control until the windows lower completely, and the top unfolds and moves forward toward the windshield header.
3. When the top lines up evenly with the windshield header, release the convertible top control.



E178453

Note: If you keep the top open for an extended period of time or if the temperature is low, the top material may shrink slightly. If this happens, pull on the latch handle to secure the top.



E174568

The final step when closing the convertible top is to lock the latch.

To lock the latch on the convertible top:

1. Pull down on the latch handle and rotate it counter-clockwise to secure the convertible top.
2. After securing the convertible top fully, push the latch handle up into the stowed position to secure the latch.

Driving Hints

BREAKING-IN

You need to break in new tires for approximately 300 mi (480 km). During this time, your vehicle may exhibit some unusual driving characteristics.

Avoid driving too fast during the first 1,000 mi (1,600 km). Vary your speed frequently and change up through the gears early. Do not labor the engine.

Do not tow during the first 1,000 mi (1,600 km).

ECONOMICAL DRIVING

Fuel economy is affected by several things such as how you drive, the conditions you drive under and how you maintain your vehicle.

There are some things to keep in mind that may improve your fuel economy:

- Accelerate and slow down in a smooth, moderate fashion.
- Drive at steady speeds.
- Anticipate stops; slowing down may eliminate the need to stop.
- Combine errands and minimize stop-and-go driving (When running errands, go to the furthest destination first and then work your way back home).
- Close the windows for high-speed driving.
- Drive at reasonable speeds.
- Keep the tires properly inflated and use only the recommended size.
- Use the recommended engine oil.
- Perform all regularly scheduled maintenance.

There are also some things you may want to avoid doing because they reduce your fuel economy:

- Avoid sudden or hard accelerations.
- Avoid revving the engine before turning off the car.
- Avoid long idle periods.
- Do not warm up your vehicle on cold mornings.
- Reduce the use of air conditioning and heat.
- Avoid using speed control in hilly terrain.
- Do not rest your foot on the brake pedal while driving.
- Avoid carrying unnecessary weight.
- Avoid adding particular accessories to your vehicle (e.g. bug deflectors, rollbars/light bars, running boards, ski racks).
- Avoid driving with the wheels out of alignment.

DRIVING THROUGH WATER

WARNING



Do not drive through flowing or deep water as you may lose control of your vehicle.

Note: *Driving through standing water can cause vehicle damage.*

Note: *Engine damage can occur if water enters the air filter.*

Before driving through standing water, check the depth. Never drive through water that is higher than the bottom of the front rocker area of your vehicle.

Driving Hints



E176360

When driving through standing water, drive very slowly and do not stop your vehicle. Your brake performance and traction may be limited. After driving through water and as soon as it is safe to do so:

- Lightly press the brake pedal to dry the brakes and to check that they work.
- Check that the horn works.
- Check that the exterior lights work.
- Turn the steering wheel to check that the steering power assist works.

FLOOR MATS

WARNINGS

 Always use floor mats that are designed to fit the foot well of your vehicle. Only use floor mats that leave the pedal area unobstructed. Only use floor mats that are firmly secured to retention posts so that they cannot slip out of position and interfere with the pedals or impair safe operation of your vehicle in other ways.

 Pedals that cannot move freely can cause loss of vehicle control and increase the risk of serious personal injury.

WARNINGS

 Always make sure that the floor mats are properly attached to the retention posts in the carpet that are supplied with your vehicle. Floor mats must be properly secured to both retention posts to make sure mats do not shift out of position.

 Never place floor mats or any other covering in the vehicle foot well that cannot be properly secured to prevent them from moving and interfering with the pedals or the ability to control the vehicle.

 Never place floor mats or any other covering on top of already installed floor mats. Floor mats should always rest on top of vehicle carpeting surface and not another floor mat or other covering. Additional floor mats or any other covering will reduce the pedal clearance and potentially interfere with pedal operation.

 Check attachment of floor mats on a regular basis. Always properly reinstall and secure floor mats that have been removed for cleaning or replacement.

 Always make sure that objects cannot fall into the driver foot well while the vehicle is moving. Objects that are loose can become trapped under the pedals causing a loss of vehicle control.

 Failure to properly follow floor mat installation or attachment instructions can potentially cause interference with pedal operation causing a loss of vehicle control.

Driving Hints



E142666

To install floor mats, position the floor mat so that the eyelet is over the retention post and press down to lock in.

To remove the floor mat, reverse the installation procedure.

Roadside Emergencies

ROADSIDE ASSISTANCE

Vehicles Sold in the United States: Getting Roadside Assistance

To fully assist you should you have a vehicle concern, Ford Motor Company offers a complimentary roadside assistance program. This program is separate from the New Vehicle Limited Warranty.

The service is available:

- 24 hours a day, seven days a week.
- For the coverage period listed on the Roadside Assistance Card included in your Owner's Manual portfolio.

Roadside Assistance covers:

- A flat tire change with a good spare (except vehicles supplied with a tire inflation kit).
- Battery jump start.
- Lock-out assistance (key replacement cost is the customer's responsibility).
- Fuel delivery — independent service contractors, if not prohibited by state, local or municipal law, shall deliver up to 2 gal (8 L) of gasoline or 5 gal (20 L) of diesel fuel to a disabled vehicle. Roadside Assistance limits fuel delivery service to two no-charge occurrences within a 12-month period.
- Winch out — available within 100 ft (30 m) of a paved or county maintained road, no recoveries.

- Towing — independent service contractors, if not prohibited by state, local or municipal law, shall tow Ford eligible vehicles to an authorized dealer within 35 mi (56 km) of the disablement location or to the nearest authorized dealer. If a member requests a tow to an authorized dealer that is more than 35 mi (56 km) from the disablement location, the member shall be responsible for any mileage costs in excess of 35 mi (56 km).
- Roadside Assistance includes up to \$200 for a towed trailer if the disabled eligible vehicle requires service at the nearest authorized dealer. If the towing vehicle is operational but the trailer is not, then the trailer does not qualify for any roadside services.

Vehicles Sold in the United States: Using Roadside Assistance

Complete the roadside assistance identification card and place it in your wallet for quick reference. This card is in the owner's information portfolio in the glove compartment.

United States vehicle customers who require Roadside Assistance, call 1-800-241-3673.

If you need to arrange roadside assistance for yourself, Ford Motor Company reimburses a reasonable amount for towing to the nearest dealership within 35 mi (56 km). To obtain reimbursement information, United States vehicle customers call 1-800-241-3673. Customers need to submit their original receipts.

Roadside Emergencies

Vehicles Sold in Canada: Getting Roadside Assistance

To fully assist you should you have a vehicle concern, Ford Motor Company of Canada, Limited offers a complimentary roadside assistance program. This program is eligible within Canada or the continental United States.

This program is separate from the New Vehicle Limited Warranty, but the coverage is concurrent with the powertrain coverage period of your vehicle.

Canadian customers who require roadside assistance, call 1-800-665-2006.

Vehicles Sold in Canada: Using Roadside Assistance

Complete the roadside assistance identification card and place it in your wallet for quick reference.

In Canada, this card is found in the Warranty Guide in the glove compartment of your vehicle.

Vehicles Sold in Canada: Roadside Assistance Program Coverage

The service is available 24 hours a day, seven days a week.

Canadian roadside coverage and benefits may differ from the U.S. coverage.

If you require more information, please refer to the coverage section of your warranty guide, call us in Canada at 1-800-665-2006, or visit our website at www.ford.ca.

HAZARD FLASHERS

Note: *The hazard warning flashers operate when the ignition is in any position, or if the key is not in the ignition. If used when the vehicle is not running, the battery lose charge. As a result, there may be insufficient power to restart your vehicle.*



You can locate the flasher control on the instrument panel. Use your hazard warning flashers when your vehicle is creating a safety hazard for other motorists.

- Press the button to switch on the hazard warning function, and the front and rear direction indicators flash.
- Press the button again to switch them off.

FUEL SHUTOFF

WARNING



Failure to inspect and, if necessary, repair fuel leaks after a collision may increase the risk of fire and serious injury. Ford Motor Company recommends that the fuel system be inspected by an authorized dealer after any collision.

In the event of a moderate to severe collision, this vehicle includes a fuel pump shut-off feature that stops the flow of fuel to the engine. Not every impact will cause a shut-off.

Roadside Emergencies

Should your vehicle shut off after a collision, you may restart your vehicle. For vehicles equipped with a push button start system:

1. Press the **START/STOP** button to switch off the ignition.
2. Press the brake pedal (automatic transmission) or the clutch pedal (manual transmission) and press the **START/STOP** button to switch on the ignition.
3. Remove your foot from the brake or clutch pedal and press the **START/STOP** button to switch off the ignition.
4. Press the brake or clutch pedal and the **START/STOP** button, or switch on the ignition only by pressing the **START/STOP** button without pressing the brake or clutch pedal. Both ways re-enable the fuel system.

Note: When you try to restart your vehicle after a fuel shutoff, the vehicle makes sure that various systems are safe to restart. Once your vehicle determines that the systems are safe, then the vehicle will allow you to restart.

Note: In the event that your vehicle does not restart after your third attempt, contact an authorized dealer.

JUMPSTARTING THE VEHICLE

WARNINGS



Batteries normally produce explosive gases which can cause personal injury. Therefore, do not allow flames, sparks or lighted substances to come near the battery. When working near the battery, always shield your face and protect your eyes. Always provide correct ventilation.

WARNINGS



Keep batteries out of reach of children. Batteries contain sulfuric acid. Avoid contact with skin, eyes or clothing. Shield your eyes when working near the battery to protect against possible splashing of acid solution. In case of acid contact with skin or eyes, flush immediately with water for a minimum of 15 minutes and get prompt medical attention. If acid is swallowed, call a physician immediately.



Use only adequately sized cables with insulated clamps.

Preparing Your Vehicle

Do not attempt to push-start your automatic transmission vehicle.

Note: Attempting to push-start a vehicle with an automatic transmission may cause transmission damage.

Note: Use only a 12-volt supply to start your vehicle.

Note: Do not disconnect the battery of the disabled vehicle as this could damage the vehicle electrical system.

Park the booster vehicle close to the hood of the disabled vehicle, making sure the two vehicles do not touch.

Connecting the Jumper Cables

WARNINGS



Do not connect the end of the second cable to the negative (-) terminal of the battery to be jumped. A spark may cause an explosion of the gases that surround the battery.



Do not use fuel lines, engine valve covers, windshield wiper arms, the intake manifold, or hood latch as ground points.

Roadside Emergencies

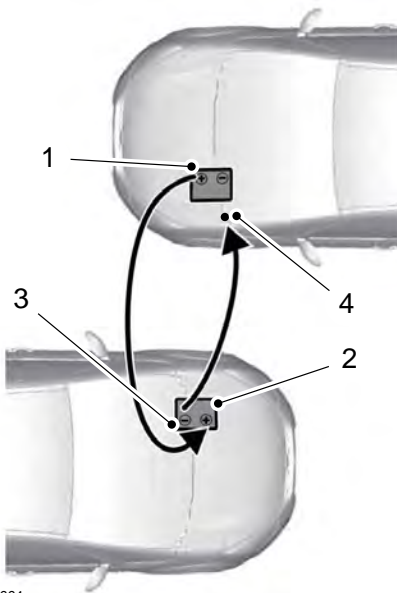

E142664

Note: In the illustration, the bottom vehicle represents the booster vehicle.

1. Connect the positive (+) jumper cable to the positive (+) terminal of the discharged battery.
2. Connect the other end of the positive (+) cable to the positive (+) terminal of the booster vehicle battery.
3. Connect the negative (-) cable to the negative (-) terminal of the booster vehicle battery.
4. Make the final connection of the negative (-) cable to an exposed metal part of the stalled vehicle's engine, away from the battery and the fuel injection system, or connect the negative (-) cable to a ground connection point if available.

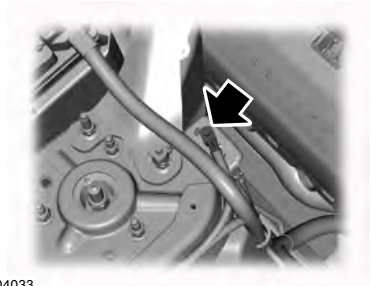

E204033

Note: You can use the optional connection point location shown above to ground your vehicle.

Jump Starting

1. Start the engine of the booster vehicle and rev the engine moderately, or press the accelerator gently to keep your engine speed between 2000 and 3000 RPM, as shown in your tachometer.
2. Start the engine of the disabled vehicle.
3. Once the disabled vehicle has been started, run both vehicle engines for an additional three minutes before disconnecting the jumper cables.

Removing the Jumper Cables

Remove the jumper cables in the reverse order that they were connected.

Roadside Emergencies

POST-CRASH ALERT SYSTEM

The system flashes the direction indicators and sounds the horn (intermittently) in the event of a serious impact that deploys an airbag (front, side, side curtain or Safety Canopy) or the seatbelt pretensioners.

The horn and indicators turn off when:

- You press the hazard control button.
- You press the panic button on the remote entry transmitter (if equipped).
- Your vehicle runs out of power.

TRANSPORTING THE VEHICLE

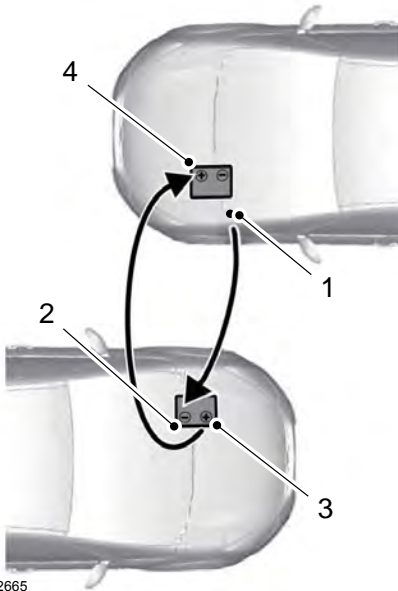

1. Remove the negative (-) jumper cable from the disabled vehicle.
2. Remove the jumper cable on the negative (-) terminal of the booster vehicle battery.
3. Remove the jumper cable from the positive (+) terminal of the booster vehicle battery.
4. Remove the jumper cable from the positive (+) terminal of the disabled vehicle battery.
5. Allow the engine to idle for at least one minute.

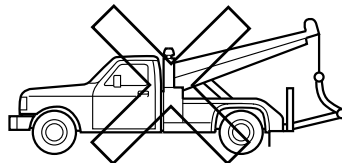
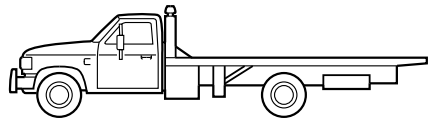
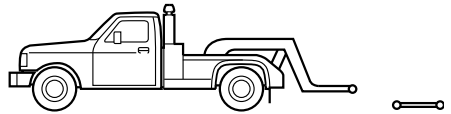

Roadside Emergencies

If you need to have your vehicle towed, contact a professional towing service or, if you are a member of a roadside assistance program, your roadside assistance service provider.

We recommend the use of a wheel lift and dollies or flatbed equipment to tow your vehicle. Do not tow with a slingbelt. Ford Motor Company has not approved a slingbelt towing procedure. Vehicle damage may occur if towed incorrectly, or by any other means.

Ford Motor Company produces a towing manual for all authorized tow truck operators. Have your tow truck operator refer to this manual for proper hook-up and towing procedures for your vehicle.

It is acceptable to have your front-wheel drive vehicle towed from the front if using proper wheel lift equipment to raise the front wheels off the ground. When towing in this manner, the rear wheels can remain on the ground.

Front-wheel drive vehicles must have the front wheels placed on a tow dolly when towing your vehicle from the rear using wheel lift equipment. This prevents damage to the transmission.

Towing an all-wheel or four-wheel drive vehicle requires that all wheels be off the ground, such as using a wheel lift and dollies or flatbed equipment. This prevents damage to the transmission, all-wheel or four-wheel drive system and vehicle.

Customer Assistance

GETTING THE SERVICES YOU NEED

Warranty repairs to your vehicle must be performed by an authorized dealer. While any authorized dealer handling your vehicle line will provide warranty service, we recommend you return to your selling authorized dealer who wants to ensure your continued satisfaction.

Please note that certain warranty repairs require special training and equipment, so not all authorized dealers are authorized to perform all warranty repairs. This means that, depending on the warranty repair needed, you may have to take your vehicle to another authorized dealer.

A reasonable time must be allowed to perform a repair after taking your vehicle to the authorized dealer. Repairs will be made using Ford or Motorcraft® parts, or remanufactured or other parts that are authorized by Ford.

Away From Home

If you are away from home when your vehicle needs service, contact the Ford Customer Relationship Center or use the online resources listed below to find the nearest authorized dealer.

In the United States:

Mailing address

Ford Motor Company
Customer Relationship Center
P.O. Box 6248
Dearborn, MI 48126

Telephone

1-800-392-3673 (FORD)
(TDD for the hearing impaired:
1-800-232-5952)

Additional information and resources are available online:

Website
www.owner.ford.com

These are some of the items that can be found online:

- U.S. dealer locator by Dealer Name, City/State or Zip Code.
- Owner Manuals.
- Maintenance Schedules.
- Recalls.
- Ford Extended Service Plans.
- Ford Genuine Accessories.
- Service specials and promotions.

In Canada:

Mailing address

Customer Relationship Centre
Ford Motor Company of Canada, Limited
P.O. Box 2000
Oakville, Ontario L6K 0C8

Telephone

1-800-565-3673 (FORD)

Website
www.ford.ca

Twitter

@FordServiceCA (English Canada)
@FordServiceQC (Quebec)

Additional Assistance

If you have questions or concerns, or are unsatisfied with the service you are receiving, follow these steps:

1. Contact your Sales Representative or Service Advisor at your selling or servicing authorized dealer.

Customer Assistance

2. If your inquiry or concern remains unresolved, contact the Sales Manager, Service Manager or Customer Relations Manager.
3. If you require assistance or clarification on Ford Motor Company policies, please contact the Ford Customer Relationship Center.

In order to help us serve you better, please have the following information available when contacting a Customer Relationship Center:

- Vehicle Identification Number.
- Your telephone number (home and business).
- The name of the authorized dealer and city where located.
- The vehicle's current odometer reading.

In some states within the United States, you must directly notify Ford in writing before pursuing remedies under your state's warranty laws, and Ford is also allowed a final repair attempt.

Additionally, in some states within the United States, a consumer has the option of submitting a warranty dispute to the BBB Auto Line before taking action under the Magnuson-Moss Warranty Act, or to the extent allowed by state law, before pursuing replacement or repurchase remedies provided by certain state laws. This dispute handling procedure is not required prior to enforcing state created rights or other rights which are independent of the Magnuson-Moss Warranty Act or state replacement or repurchase laws.

IN CALIFORNIA (U.S. ONLY)

California Civil Code Section 1793.2(d) requires that, if a manufacturer or its representative is unable to repair a motor vehicle to conform to the vehicle's applicable express warranty after a reasonable number of attempts, the manufacturer shall be required to either replace the vehicle with one substantially identical or repurchase the vehicle and reimburse the buyer in an amount equal to the actual price paid or payable by the consumer (less a reasonable allowance for consumer use). The consumer has the right to choose whether to receive a refund or replacement vehicle.

California Civil Code Section 1793.22(b) presumes that the manufacturer has had a reasonable number of attempts to conform the vehicle to its applicable express warranties if, within the first 18 months of ownership of a new vehicle or the first 18,000 mi (29,000 km), whichever occurs first:

1. Two or more repair attempts are made on the same non-conformity likely to cause death or serious bodily injury OR
2. Four or more repair attempts are made on the same nonconformity (a defect or condition that substantially impairs the use, value or safety of the vehicle) OR
3. The vehicle is out of service for repair of nonconformities for a total of more than 30 calendar days (not necessarily all at one time).

In the case of 1 or 2 above, the consumer must also notify the manufacturer of the need for the repair of the nonconformity at the following address:

Ford Motor Company
16800 Executive Plaza Drive
Mail Drop 3NE-B
Dearborn, MI 48126

Customer Assistance

You are required to submit your warranty dispute to BBB AUTO LINE before asserting in court any rights or remedies conferred by California Civil Code Section 1793.22(b). You are also required to use BBB AUTO LINE before exercising rights or seeking remedies created by the Federal Magnuson-Moss Warranty Act, 15 U.S.C. sec. 2301 et seq. If you choose to seek redress by pursuing rights and remedies not created by California Civil Code Section 1793.22(b) or the Magnuson-Moss Warranty Act, resort to BBB AUTO LINE is not required by those statutes.

THE BETTER BUSINESS BUREAU (BBB) AUTO LINE PROGRAM (U.S. ONLY)

Your satisfaction is important to Ford Motor Company and to your dealer. If a warranty concern has not been resolved using the three-step procedure outlined earlier in this chapter in the Getting the Services you need section, you may be eligible to participate in the BBB AUTO LINE program.

The BBB AUTO LINE program consists of two parts – mediation and arbitration. During mediation, a representative of the BBB will contact both you and Ford Motor Company to explore options for settlement of the claim. If an agreement is not reached during mediation or you do not want to participate in mediation, and if your claim is eligible, you may participate in the arbitration process. An arbitration hearing will be scheduled so that you can present your case in an informal setting before an impartial person. The arbitrator will consider the testimony provided and make a decision after the hearing.

Disputes submitted to the BBB AUTO LINE program are usually decided within forty days after you file your claim with the BBB. You are not bound by the decision, and may reject the decision and proceed to court where all findings of the BBB Auto Line dispute, and decision, are admissible in the court action. Should you choose to accept the BBB AUTO LINE decision, Ford is then bound by the decision, and must comply with the decision within 30 days of receipt of your acceptance letter.

BBB AUTO LINE Application: Using the information provided below, please call or write to request a program application. You will be asked for your name and address, general information about your new vehicle, information about your warranty concerns, and any steps you have already taken to try to resolve them. A Customer Claim Form will be mailed that will need to be completed, signed and returned to the BBB along with proof of ownership. Upon receipt, the BBB will review the claim for eligibility under the Program Summary Guidelines.

You can get more information by calling BBB AUTO LINE at 1-800-955-5100, or writing to:

**BBB AUTO LINE
3033 Wilson Boulevard, Suite 600
Arlington, Virginia 22201**

BBB AUTO LINE applications can also be requested by calling the Ford Motor Company Customer Relationship Center at 1-800-392-3673.

Note: *Ford Motor Company reserves the right to change eligibility limitations, modify procedures, or to discontinue this process at any time without notice and without obligation.*

Customer Assistance

UTILIZING THE MEDIATION/ARBITRATION PROGRAM (CANADA ONLY)

For vehicles delivered to authorized Canadian dealers. In those cases where you continue to feel that the efforts by Ford of Canada and the authorized dealer to resolve a factory-related vehicle service concern have been unsatisfactory, Ford of Canada participates in an impartial third party mediation/arbitration program administered by the Canadian Motor Vehicle Arbitration Plan (CAMVAP).

The CAMVAP program is a straight forward and relatively speedy alternative to resolve a disagreement when all other efforts to produce a settlement have failed. This procedure is without cost to you and is designed to eliminate the need for lengthy and expensive legal proceedings.

In the CAMVAP program, impartial third-party arbitrators conduct hearings at mutually convenient times and places in an informal environment. These impartial arbitrators review the positions of the parties, make decisions and, when appropriate, render awards to resolve disputes. CAMVAP decisions are fast, fair, and final as the arbitrator's award is binding on both you and Ford of Canada.

CAMVAP services are available in all Canadian territories and provinces. For more information, without charge or obligation, call your CAMVAP Provincial Administrator directly at 1-800-207-0685 or visit www.camvap.ca.

GETTING ASSISTANCE OUTSIDE THE U.S. AND CANADA

Before exporting your vehicle to a foreign country, contact the appropriate foreign embassy or consulate. These officials can inform you of local vehicle registration regulations and where to find unleaded fuel or petrol/gas engines or the proper sulfur fuel for diesel engines.

If you cannot find the proper fuel recommended for your vehicle, contact our Customer Relationship Center.

The use of improper fuels in your vehicle without proper conversion may damage the effectiveness of your emission control system and may cause engine knocking or serious engine damage. Ford Motor Company or Ford of Canada is not responsible for any damage caused by use of improper fuel. Using improper fuels may also result in difficulty importing your vehicle back into the United States.

If your vehicle must be serviced while you are traveling or living in Asia-Pacific Region, Sub-Saharan Africa, U.S. Virgin Islands and/or Puerto Rico, Central America, the Caribbean, and Israel and the Middle East, contact the nearest authorized dealer. If the authorized dealer cannot help you, contact the corresponding Ford Customer Assistance Center:

FORD MOTOR COMPANY
Customer Relationship Centers in:

Customer Assistance

Customer Relationship Center	Phone	Fax	E-mail
Asia Pacific	N/A	N/A	apemrc@ford.com
Caribbean and Central America	+1 313 594 4857	-	expcac@ford.com
Middle East	Ford 80004443673	971 4 3327 266	menacac@ford.com
	Lincoln 80004441067		
	UAE 80004441066		
	Saudi Arabia 8008443673		
	Mobily and Zain cell phone users in Saudi 800850078		
Puerto Rico and U.S. Virgin Islands	+1-800-841-3673	N/A	prcac@ford.com
Sub-Saharan Africa	+1-313-594-4857	N/A	ssacrc@ford.com
South Korea	+63-2-717-6410	N/A	infokr1@ford.com or infokr@lincoln.com

If you buy your vehicle in North America and then relocate to any of the above locations, register your vehicle identification number (VIN) and new address with Ford Global Trade Services by emailing, expcso@ford.com.

If you are in another foreign country, contact the nearest authorized dealer. In the event your inquiry is unresolved, communicate your concern with the dealership's Sales Manager, Service Manager or Customer Relations Manager. If you require additional assistance or clarification, please contact the respective Customer Relationship Center as previously listed.

Customers in the U.S. should call 1-800-392-3673.

ORDERING ADDITIONAL OWNER'S LITERATURE

To order the publications in this portfolio, contact Helm, Incorporated at:

HELM, INCORPORATED
47911 Halyard Drive
Plymouth, Michigan 48170
Attention: Customer Service

Or to order a free publication catalog, call toll free: 1-800-782-4356

Monday-Friday 8:00 a.m. - 6:00 p.m. EST

Customer Assistance

Helm, Incorporated can also be reached by their website:

www.helminc.com

(Items in this catalog may be purchased by credit card, check or money order.)

Obtaining a French Owner's Manual

French Owner's Manual can be obtained from your authorized dealer or by contacting Helm, Incorporated using the contact information listed previously in this section.

REPORTING SAFETY DEFECTS (U.S. ONLY)



E142557

If you believe that your vehicle has a defect which could cause a crash or could cause injury or death, you should immediately inform the National Highway Traffic Safety Administration (NHTSA) in addition to notifying Ford Motor Company.

If NHTSA receives similar complaints, it may open an investigation, and if it finds that a safety defect exists in a group of vehicles, it may order a recall and remedy campaign. However, NHTSA cannot become involved in individual problems between you, your dealer, or Ford Motor Company.

To contact NHTSA, you may call the Vehicle Safety Hotline toll-free at 1-888-327-4236 (TTY: 1-800-424-9153); go to <http://www.safercar.gov>; or write to:

Administrator

1200 New Jersey Avenue,
Southeast

Washington, D.C. 20590

You can also obtain other information about motor vehicle safety from <http://www.safercar.gov>.

REPORTING SAFETY DEFECTS (CANADA ONLY)

If you believe that your vehicle has a defect which could cause a crash or could cause injury or death, you should immediately inform Transport Canada and Ford of Canada.

Customer Assistance

Transport Canada Contact Information	
Website	http://www.tc.gc.ca/eng/motorvehiclesafety/reporting-defects-motor-vehicles.html (English)
Website	http://www.tc.gc.ca/fra/securiteautomobile/signaler-defauts-vehicules-automobiles.html (French)
Phone	1-800-333-0510

Ford of Canada Contact Information	
Website	www.ford.ca
Phone	1-800-565-3673

Fuses

FUSE SPECIFICATION CHART

Power Distribution Box

WARNINGS



Always disconnect the battery before servicing high current fuses.



To reduce risk of electrical shock, always replace the cover to the power distribution box before reconnecting the battery or refilling fluid reservoirs.

The power distribution box is located in the engine compartment. It has high-current fuses that protect your vehicle's main electrical systems from overloads.

If you disconnect and reconnect the battery, you will need to reset some features. See **Changing the 12V Battery** (page 222).

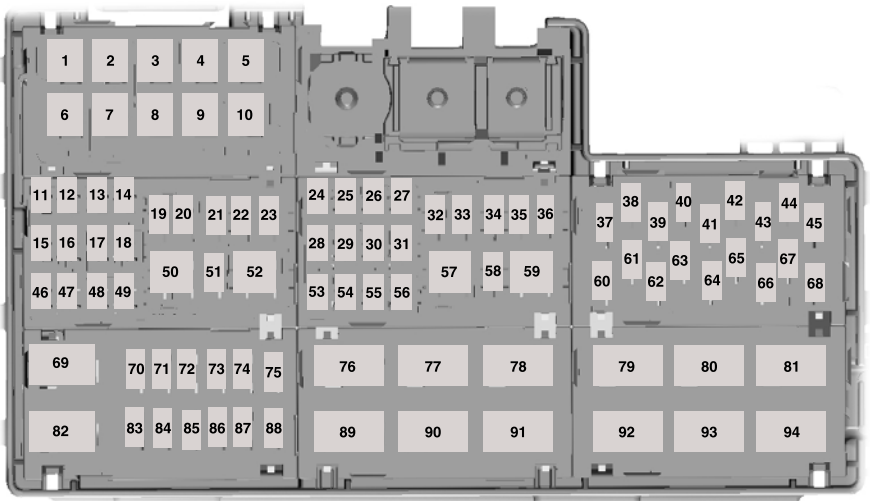

E174563

Fuse or relay number	Fuse amp rating	Protected components
1	—	Not used.
2	—	Not used.
3	—	Not used.

Fuses

Fuse or relay number	Fuse amp rating	Protected components
4	—	Not used.
5	50A ¹	Automatic brake system pump.
6	50A ¹	Body control module.
7	60A ¹	Body control module.
8	50A ¹	Body control module.
9	40A ¹	Rear window defroster.
10	40A ¹	Blower motor.
11	30A ²	Left-hand front window.
12	30A ²	Driver seat.
13	30A ²	Passenger seat.
14	30A ²	Climate-controlled seat module.
15	20A ²	Convertible top motor.
16	—	Not used.
17	20A ²	Convertible top motor.
18	—	Not used.
19	20A ³	Steering column lock relay.
20	10A ³	Brake on-off switch.
21	20A ³	Horn.
22	10A ³	Powertrain control module relay.
23	10A ³	Air conditioning clutch.
24	30A ²	Voltage quality module.
25	—	Not used.

Fuses

Fuse or relay number	Fuse amp rating	Protected components
26	25A ²	Windshield wiper motor.
27	—	Not used.
28	30A ²	Automatic brake system valve.
29	30A ²	Electronic fan 1.
30	30A ²	Starter motor solenoid.
31	40A ²	Electronic fan 3.
32	10A ³	Latch relay coil.
33	20A ³	Left-hand high-intensity discharge headlamps.
34	15A ³	Exhaust valves.
35	20A ³	Right-hand high-intensity discharge headlamps.
36	10A ³	Alt sense.
37	—	Not used.
38	20A ³	Vehicle power 1.
39	—	Not used.
40	20A ³	Vehicle power 2.
41	15A ³	Fuel injectors.
42	15A ³	Vehicle power 3.
43	—	Not used.
44	15A ³	Vehicle power 4.
	30A ³	Ignition coils (GT350 only).
45	—	Not used.
46	20A ²	Differential pump.

Fuses

Fuse or relay number	Fuse amp rating	Protected components
47	—	Not used.
48	30A ²	Fuel pump #2.
49	30A ²	Fuel pump.
50	—	Steering column lock relay.
51	—	Not used.
52	—	Horn relay.
53	20A ²	Cigar lighter.
54	20A ²	Auxiliary power point.
55	25A ²	Electronic fan 2.
56	—	Not used.
57	—	Air conditioning clutch relay.
58	—	Not used.
59	—	Exhaust valves relay.
60	5A ³	Powertrain control module.
61	—	Not used.
62	5A ³	Anti-lock brakes run-start switch.
63	—	Not used.
64	5A ³	Electronic power assist steering.
65	—	Not used.
66	5A ³	Blind spot information system. Rear view camera. Air conditioning compressor relay coils.
67	—	Not used.
68	10A ³	Headlamp leveling switch.
69	—	Auxiliary power point relay.

Fuses

Fuse or relay number	Fuse amp rating	Protected components
70	10A ³	Heated exterior mirrors.
71	—	Not used.
72	5A ³	Rain sensor module.
73	—	Not used.
74	5A ³	Mass air flow sensor.
75	—	Not used.
76	—	Rear window defroster relay.
77	—	Electronic cooling fan 2 relay.
78	—	Left-hand high-intensity discharge headlamp relay (export).
79	—	Right-hand high-intensity-discharge headlamp relay (export).
80	—	Windshield wiper relay.
81	—	Starter motor solenoid relay.
82	—	Powertrain control module relay.
83	—	Not used.
84	—	Not used.
85	—	Not used.
86	—	Not used.
87	—	Not used.
88	—	Not used.
89	—	Electronic fan 1 relay.
90	—	Differential pump relay.
91	—	Electronic fan 3 relay.
92	—	Blower motor relay.
93	—	Fuel pump #2 relay.

Fuses

Fuse or relay number	Fuse amp rating	Protected components
94	—	Fuel pump relay.

¹J-case fuses.

²M-case fuses.

³Micro fuses.

Passenger Compartment Fuse Panel

The fuse panel is in the right-hand side of the passenger footwell behind a trim panel and plastic key code card.

To remove the trim panel, lift it from the rear retaining hooks, while pulling it toward you and swinging it away from the side. To reinstall it, line up the tabs with the grooves on the panel, drop the panel back into place, and then push it shut.

To reach the fuse panel, first remove the key code card.

After replacing a fuse, return the key code card to the original position. To reinstall the trim panel, lineup the tabs with the grooves on the panel, drop the panel back into place, and then push it shut to reinstall the trim panel.

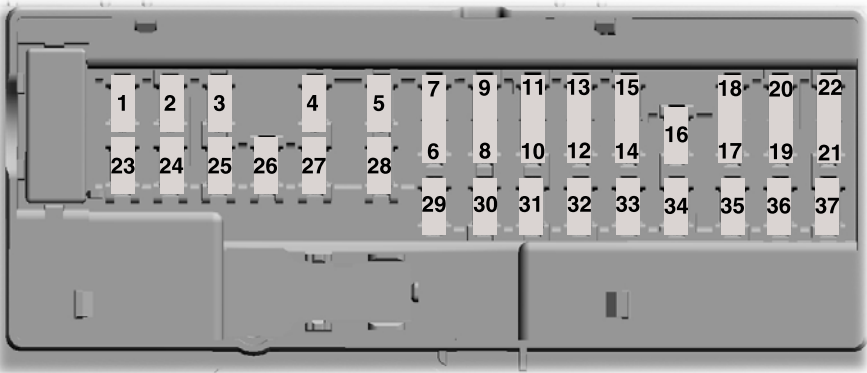

E174564

Fuses

Fuse or relay number	Fuse amp rating	Protected components
1	10A	Demand lamps.
2	7.5A	Power mirror memory module.
3	20A	Driver console unlock.
4	—	Not used.
5	20A	Subwoofer amplifier.
6	—	Not used.
7	—	Not used.
8	—	Not used.
9	—	Not used.
10	—	Not used.
11	—	Not used.
12	7.5A	Climate control module.
13	7.5A	Gateway module. Steering column control module. Instrument cluster.
14	—	Not used.
15	10A	Gateway module.
16	15A	Decklid release.
17	5A	Not used (spare).
18	5A	Intrusion sensor module.
19	7.5A	Passenger airbag deactivation indicator.
20	—	Not used.
21	5A	In-vehicle temperature and humidity sensor.
22	5A	Occupant classification system module.
23	10A	Switches. Power windows. Rear-view mirror.

Fuses

Fuse or relay number	Fuse amp rating	Protected components
24	20A	Central lock unlock.
25	30A	MagneRide.
26	30A	Right-hand front-window motor.
27	30A	Amplifier.
28	20A	Auxiliary body module.
29	30A	Left-hand rear-window power.
30	30A	Right-hand rear-window power.
31	—	Not used.
32	10A	Remote keyless entry. Multi-function display. SYNC. Global positioning system module. Gauges.
33	20A	Audio head unit.
34	30A	Run-start bus.
35	5A	Restraints control module.
36	15A	Auxiliary body module.
37	20A	Power distribution box run-start bus.

CHANGING A FUSE

Fuses

WARNING



Always replace a fuse with one that has the specified amperage rating. Using a fuse with a higher amperage rating can cause severe wire damage and could start a fire.



E217331

If electrical components in the vehicle are not working, a fuse may have blown. Blown fuses are identified by a broken wire within the fuse. Check the appropriate fuses before replacing any electrical components.

Fuses

Fuse Types

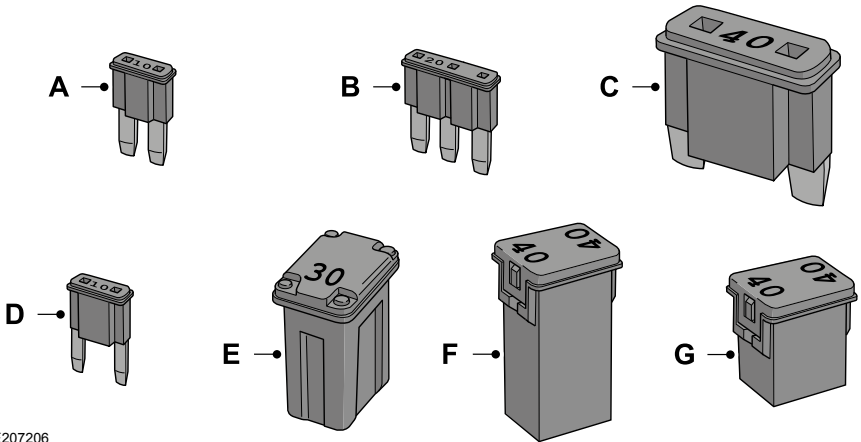

E207206

Callout	Fuse Type
A	Micro 2
B	Micro 3
C	Maxi
D	Mini
E	M Case
F	J Case
G	J Case Low Profile

Maintenance

GENERAL INFORMATION

Have your vehicle serviced regularly to help maintain its roadworthiness and resale value. There is a large network of authorized dealers that are there to help you with their professional servicing expertise. We believe that their specially trained technicians are best qualified to service your vehicle properly and expertly. They are supported by a wide range of highly specialized tools developed specifically for servicing your vehicle.

If your vehicle requires professional service, an authorized dealer can provide the necessary parts and service. Check your warranty information to find out which parts and services are covered.

Use only recommended fuels, lubricants, fluids and service parts conforming to specifications. Motorcraft® parts are designed and built to provide the best performance in your vehicle.

Precautions

- Do not work on a hot engine.
- Make sure that nothing gets caught in moving parts.
- Do not work on a vehicle with the engine running in an enclosed space, unless you are sure you have enough ventilation.
- Keep all open flames and other burning material (such as cigarettes) away from the battery and all fuel related parts.

Working with the Engine Off

1. Set the parking brake and shift to park (P).
2. Switch off the engine.
3. Block the wheels.

Working with the Engine On

WARNING



To reduce the risk of vehicle damage and/or personal burn injuries, do not start your engine with the air cleaner removed and do not remove it while the engine is running.

1. Set the parking brake and shift to park (P).
2. Block the wheels.

OPENING AND CLOSING THE HOOD

Opening the Hood



E142457

1. Inside the vehicle, pull the hood release handle located under the left-hand side of the instrument panel.
2. Slightly lift the hood.

Maintenance

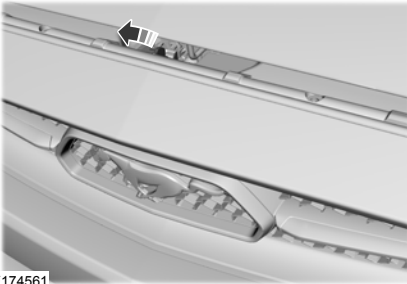

E174561

3. Release the hood latch by pushing the secondary release lever to your left-hand side.



E87786

4. Open the hood. Support the hood with the strut.

Closing the Hood

1. Remove the hood strut from the catch and secure it correctly after use.
2. Lower the hood and allow it to drop under its own weight for the last 8–12 in (20–30 cm).

Note: Make sure that the hood is correctly closed.

Maintenance

UNDER HOOD OVERVIEW - 2.3L ECOBOOST™

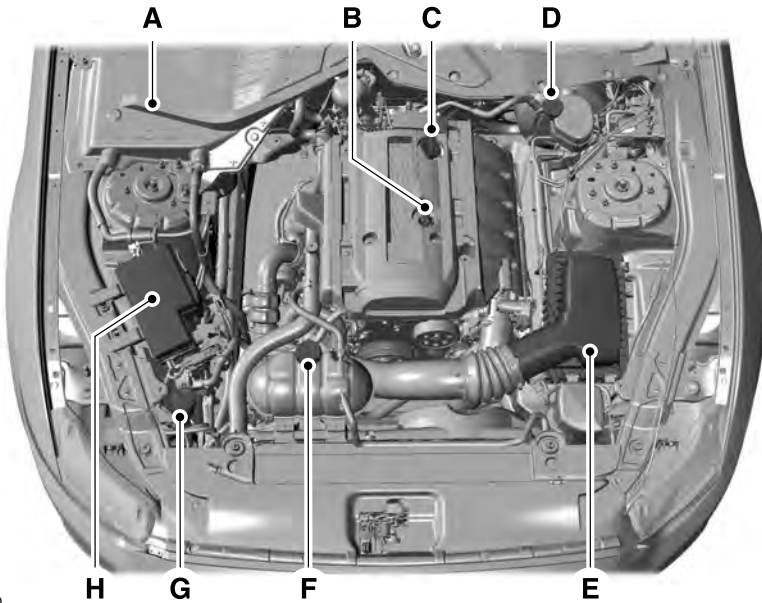

E174450

- A Battery (out of view). See **Changing the 12V Battery** (page 222).
- B Engine oil dipstick. See **Engine Oil Dipstick** (page 215).
- C Engine oil filler cap. See **Engine Oil Check** (page 215).
- D Brake fluid reservoir. See **Brake Fluid Check** (page 221).
- E Air filter assembly. See **Changing the Engine Air Filter** (page 229).
- F Engine coolant reservoir. See **Engine Coolant Check** (page 216).
- G Windshield washer fluid reservoir. See **Washer Fluid Check** (page 222).
- H Power distribution box. See **Fuses** (page 201).

Maintenance

UNDER HOOD OVERVIEW - 3.7L

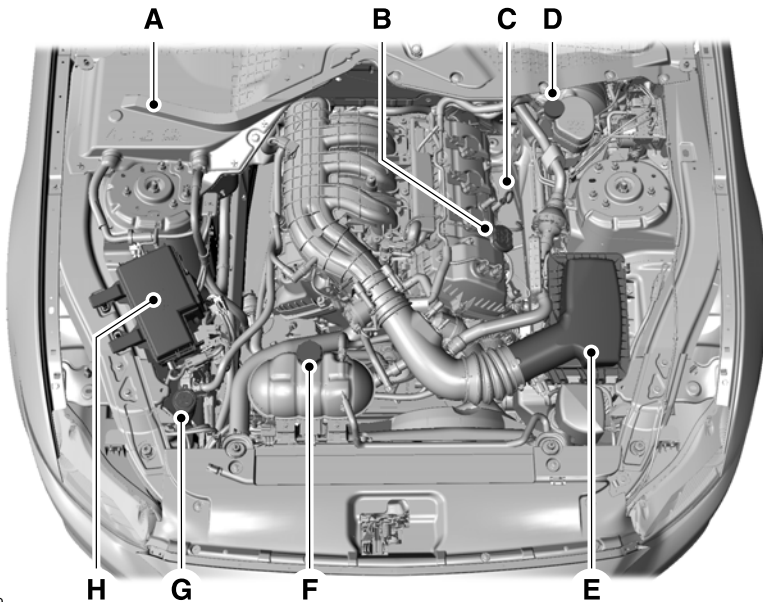

E174559

- A. Battery (out of view). See **Changing the 12V Battery** (page 222).
- B. Engine oil filler cap. See **Engine Oil Check** (page 215).
- C. Engine oil dipstick. See **Engine Oil Dipstick** (page 215).
- D. Brake fluid reservoir. See **Brake Fluid Check** (page 221).
- E. Air filter assembly. See **Changing the Engine Air Filter** (page 229).
- F. Engine coolant reservoir. See **Engine Coolant Check** (page 216).
- G. Windshield washer fluid reservoir. See **Washer Fluid Check** (page 222).
- H. Power distribution box. See **Fuses** (page 201).

Maintenance

UNDER HOOD OVERVIEW - 5.0L

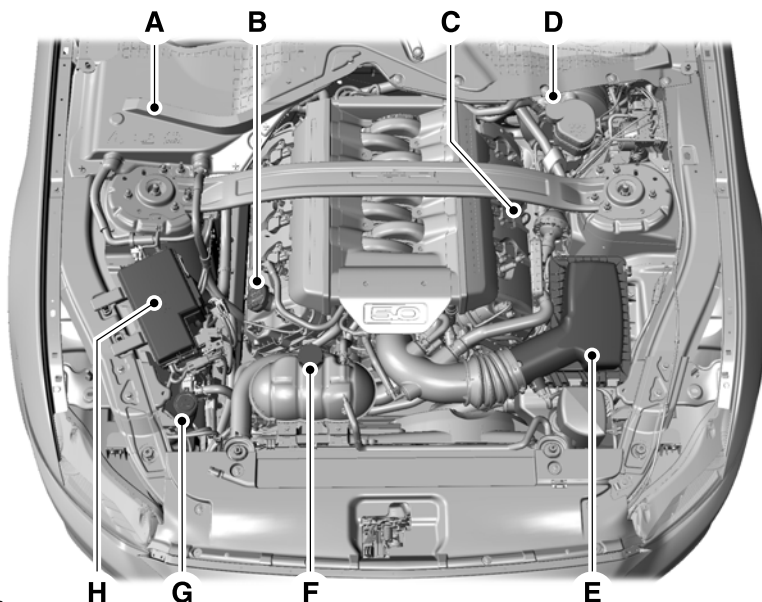

E174560

- A. Battery. See **Changing the 12V Battery** (page 222).
- B. Engine oil filler cap. See **Engine Oil Check** (page 215).
- C. Engine oil dipstick. See **Engine Oil Dipstick** (page 215).
- D. Brake fluid reservoir. See **Brake Fluid Check** (page 221).
- E. Air filter. See **Changing the Engine Air Filter** (page 229).
- F. Engine coolant reservoir. See **Engine Coolant Check** (page 216).
- G. Washer system fluid reservoir. See **Washer Fluid Check** (page 222).
- H. Engine compartment fuse box. See **Fuses** (page 201).

Maintenance

ENGINE OIL DIPSTICK



E161560

- A MIN
- B MAX

ENGINE OIL CHECK

To check the engine oil level consistently and accurately, do the following:

1. Make sure the parking brake is on. Make sure the transmission is in park (P) or neutral (N).
2. Run the engine until it reaches normal operating temperature.
3. Make sure that your vehicle is on level ground.
4. Switch the engine off and wait 15 minutes for the oil to drain into the oil pan. Checking the engine oil level too soon after you switch the engine off may result in an inaccurate reading.
5. Open the hood. See **Opening and Closing the Hood** (page 210).
6. Remove the dipstick and wipe it with a clean, lint-free cloth.
7. Replace the dipstick and remove it again to check the oil level. See **Engine Oil Dipstick** (page 215).

8. Make sure that the oil level is between the maximum and minimum marks. If the oil level is at the minimum mark, add oil immediately. See **Capacities and Specifications** (page 278).
9. If the oil level is correct, replace the dipstick and make sure it is fully seated.

Note: Do not remove the dipstick when the engine is running.

Note: If the oil level is between the maximum and minimum marks, the oil level is acceptable. Do not add oil.

Note: The oil consumption of new engines reaches its normal level after approximately 3,100 mi (5,000 km).

Adding Engine Oil

WARNING



Do not remove the filler cap when the engine is running.

Do not use supplemental engine oil additives because they are unnecessary and could lead to engine damage that may not be covered by the vehicle Warranty.



E142732

Maintenance

Only use oils certified for gasoline engines by the American Petroleum Institute (API). An oil with this trademark symbol conforms to the current engine and emission system protection standards and fuel economy requirements of the International Lubricants Specification Advisory Committee (ILSAC).

To top up the engine oil level do the following:

1. Clean the area surrounding the engine oil filler cap before you remove it.
2. Remove the engine oil filler cap. Turn it counterclockwise and remove it.
3. Add engine oil that meets Ford specifications. See **Capacities and Specifications** (page 278). You may have to use a funnel to pour the engine oil into the opening.
4. Recheck the oil level.
5. If the oil level is correct, replace the dipstick and make sure it is fully seated.
6. Replace the engine oil filler cap. Turn it clockwise until you feel a strong resistance.

Note: Do not add oil further than the maximum mark. Oil levels above the maximum mark may cause engine damage.

Note: Make sure you install the oil filler cap correctly.

Note: Soak up any spillage with an absorbent cloth immediately.

ENGINE COOLANT CHECK

WARNINGS



Do not remove the coolant reservoir cap when the cooling system is hot. Wait 10 minutes for the cooling system to cool down. Cover the coolant reservoir cap with a thick cloth to prevent the possibility of scalding and slowly remove the cap. Failure to follow this instruction could result in personal injury.



Do not put coolant in the windshield washer fluid reservoir. If sprayed on the windshield, coolant could make it difficult to see through the windshield.



To reduce the risk of personal injury, make sure the engine is cool before unscrewing the coolant pressure relief cap. The cooling system is under pressure. Steam and hot liquid can come out forcefully when you loosen the cap slightly.



Do not add coolant further than the **MAX** mark.

When the engine is cold, check the concentration and level of the coolant at the intervals listed in the scheduled maintenance information. See **Scheduled Maintenance** (page 422).

Note: Make sure that the coolant level is between the **MIN** and **MAX** marks on the coolant reservoir.

Note: Coolant expands when it is hot. The level may extend beyond the **MAX** mark.

Maintain coolant concentration within 48% to 50%, which equates to a freeze point between -30°F (-34°C) and -34°F (-37°C). Coolant concentration should be checked using a refractometer. We do not recommend the use of hydrometers or coolant test strips for measuring coolant concentration.

Maintenance

Adding Coolant

WARNING



Never remove the coolant reservoir cap when the engine is running or hot.

Note: *Automotive fluids are not interchangeable. Take care not to put engine coolant in the windshield washer fluid reservoir or windshield washer fluid in the engine coolant reservoir.*

Note: *Do not use stop leak pellets, cooling system sealants, or non-specified additives as they can cause damage to the engine cooling or heating systems. Resulting component damage may not be covered by the vehicle Warranty.*

It is very important to use prediluted coolant approved to the correct specification in order to avoid plugging the small passageways in the engine cooling system. See **Capacities and Specifications** (page 271). Do not mix different colors or types of coolant in your vehicle. Mixing of engine coolants or using an incorrect coolant may harm the engine or cooling system components and may not be covered by the vehicle Warranty.

Note: *If prediluted coolant is not available, use the approved concentrated coolant diluting it to 50/50 with distilled water. See **Capacities and Specifications** (page 271). Using water that has not been deionised may contribute to deposit formation, corrosion and plugging of the small cooling system passageways.*

Note: *Coolants marketed for all makes and models may not be approved to Ford specifications and may cause damage to the cooling system. Resulting component damage may not be covered by the vehicle Warranty.*

If the coolant level is at or below the minimum mark, add prediluted coolant immediately.

To top up the coolant level do the following:

1. Unscrew the cap slowly. Any pressure escapes as you unscrew the cap.
2. Add prediluted coolant approved to the correct specification. See **Capacities and Specifications** (page 271).
3. Add enough prediluted coolant to reach the correct level.
4. Replace the coolant reservoir cap, turn it clockwise until you feel a strong resistance.
5. Check the coolant level in the coolant reservoir the next few times you drive your vehicle. If necessary, add enough prediluted engine coolant to bring the coolant level to the correct level.

If you have to add more than 1.1 qt (1 L) of engine coolant per month, have your vehicle checked as soon as possible. Operating an engine with a low level of coolant can result in engine overheating and possible engine damage.

Note: *During normal vehicle operation, the coolant may change color from orange to pink or light red. As long as the coolant is clear and uncontaminated, this color change does not indicate the coolant has degraded nor does it require the coolant to be drained, the system to be flushed, or the coolant to be replaced.*

In case of emergency, you can add a large amount of water without engine coolant in order to reach a vehicle service location. In this instance, qualified personnel:

1. Must drain the cooling system.
2. Chemically clean the coolant system with Motorcraft Premium Cooling System Flush.

Maintenance

3. Refill with engine coolant as soon as possible.

Water alone, without engine coolant, can cause engine damage from corrosion, overheating or freezing.

Do not use the following as a coolant substitute:

- Alcohol.
- Methanol.
- Brine.
- Any coolant mixed with alcohol or methanol antifreeze.

Alcohol and other liquids can cause engine damage from overheating or freezing.

Do not add extra inhibitors or additives to the coolant. These can be harmful and compromise the corrosion protection of the coolant.

Recycled Coolant

We do not recommend the use of recycled coolant as an approved recycling process is not yet available.

Dispose of used engine coolant in an appropriate manner. Follow your community's regulations and standards for recycling and disposing of automotive fluids.

Severe Climates

If you drive in extremely cold climates:

- It may be necessary to increase the coolant concentration above 50%.
- A coolant concentration of 60% provides improved freeze point protection. Coolant concentrations above 60% decrease the overheat protection characteristics of the coolant and may cause engine damage.

If you drive in extremely hot climates:

- You can decrease the coolant concentration to 40%.
- Coolant concentrations below 40% decrease the freeze and corrosion protection characteristics of the coolant and may cause engine damage.

Vehicles driven year-round in non-extreme climates should use prediluted coolant for optimum cooling system and engine protection.

Coolant Change

At specific mileage intervals, as listed in the scheduled maintenance information, the coolant should be changed. Add prediluted coolant approved to the correct specification. See **Capacities and Specifications** (page 271).

Fail-Safe Cooling

Fail-safe cooling allows you to temporarily drive your vehicle before any incremental component damage occurs. The fail-safe distance depends on ambient temperature, vehicle load and terrain.

How Fail-Safe Cooling Works



If the engine begins to overheat, the coolant temperature gauge moves toward the red zone:



A warning lamp illuminates and a message may appear in the information display.

If the engine reaches a preset over-temperature condition, the engine automatically switches to alternating cylinder operation. Each disabled cylinder acts as an air pump and cools the engine.

Maintenance

When this occurs, your vehicle still operates, however:

- Engine power is limited.
- The air conditioning system turns off.

Continued operation increases the engine temperature, causing the engine to completely shut down. Your steering and braking effort increases in this situation.

When the engine temperature cools, you can re-start the engine. Have your vehicle checked as soon as possible to minimize engine damage.

When Fail-Safe Mode Is Activated

WARNINGS



Fail-safe mode is for use during emergencies only. Operate your vehicle in fail-safe mode only as long as necessary to bring your vehicle to rest in a safe location and seek immediate repairs. When in fail-safe mode, your vehicle will have limited power, will not be able to maintain high-speed operation, and may completely shut down without warning, potentially losing engine power, power steering assist, and power brake assist, which may increase the possibility of a crash resulting in serious injury.



Never remove the coolant reservoir cap when the engine is running or hot.

Your vehicle has limited engine power when in the fail-safe mode, drive your vehicle with caution. Your vehicle does not maintain high-speed operation and the engine may operate poorly.

Remember that the engine is capable of automatically shutting down to prevent engine damage. In this situation:

1. Pull off the road as soon as safely possible and switch the engine off.

2. If you are a member of a roadside assistance program, we recommend that you contact your roadside assistance service provider.
3. If this is not possible, wait a short period for the engine to cool.
4. Check the coolant level. If the coolant level is at or below the minimum mark, add prediluted coolant immediately.
5. When the engine temperature cools, you can re-start the engine. Have your vehicle checked as soon as possible to minimize engine damage.

Note: *Driving your vehicle without repair increases the chance of engine damage.*

Engine Coolant Temperature Management (If Equipped)

WARNING



To reduce the risk of crash and injury, be prepared that the vehicle speed may reduce and the vehicle may not be able to accelerate with full power until the coolant temperature reduces.

If you tow a trailer with your vehicle, the engine may temporarily reach a higher temperature during severe operating conditions, for example ascending a long or steep grade in high ambient temperatures.

At this time, you may notice the coolant temperature gauge moves toward the red zone and a message may appear in the information display.

Maintenance

You may notice a reduction in vehicle speed caused by reduced engine power in order to manage the engine coolant temperature. Your vehicle may enter this mode if certain high-temperature and high-load conditions take place. The amount of speed reduction depends on vehicle loading, grade and ambient temperature. If this occurs, there is no need to pull off the road. You can continue to drive your vehicle.

The air conditioning may automatically turn on and off during severe operating conditions to protect the engine from overheating. When the coolant temperature decreases to the normal operating temperature, the air conditioning turns on.

If the coolant temperature gauge moves fully into the red zone, or if the coolant temperature warning or service engine soon messages appear in your information display, do the following:

1. Pull off the road as soon as safely possible and shift the transmission into park **(P)**.
2. Leave the engine running until the coolant temperature gauge needle returns to the normal position. After several minutes, if the temperature does not drop, follow the remaining steps.
3. Switch the engine off and wait for it to cool. Check the coolant level.
4. If the coolant level is at or below the minimum mark, add prediluted coolant immediately.
5. If the coolant level is normal, restart the engine and continue.

MANUAL TRANSMISSION FLUID CHECK

1. Clean the filler plug. The filler plug is on the right-hand side of the transmission.

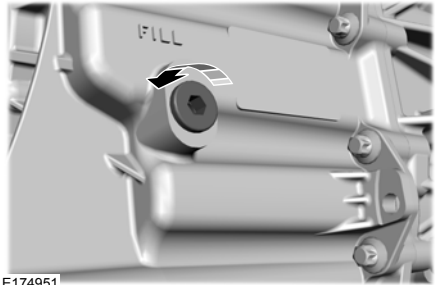

E174951

2. Remove the filler plug.
3. The correct fluid fill level is 0.0–0.1 in (0–3 mm) below the bottom edge of the filler hole.
4. Add fluid through the filler hole.
5. Install the filler plug.
6. Tighten the filler plug until you feel a strong resistance.

Only use fluid that meets Ford specifications. See **Capacities and Specifications** (page 271).

AUTOMATIC TRANSMISSION FLUID CHECK

If required, have an authorized dealer check and change the transmission fluid at the correct service interval. See **Scheduled Maintenance** (page 422).

The automatic transmission does not have a transmission fluid dipstick.

Maintenance

Refer to your scheduled maintenance information for scheduled intervals for fluid checks and changes. Your transmission does not consume fluid. However, if the transmission slips, shifts slowly or if you notice a sign of leaking fluid, contact an authorized dealer.

Do not use supplemental transmission fluid additives, treatments or cleaning agents. The use of these materials may affect transmission operation and result in damage to internal transmission components.

BRAKE FLUID CHECK

WARNINGS



Do not use any fluid other than the recommended brake fluid as this will reduce brake efficiency. Use of incorrect fluid could result in the loss of vehicle control, serious personal injury or death.



Only use brake fluid from a sealed container. Contamination with dirt, water, petroleum products or other materials may result in brake system damage or failure. Failure to adhere to this warning could result in the loss of vehicle control, serious personal injury or death.



Do not allow the fluid to touch your skin or eyes. If this happens, rinse the affected areas immediately with plenty of water and contact your physician.



A fluid level between the **MAX** and **MIN** lines is within the normal operating range and there is no need to add fluid. A fluid level not in the normal operating range could compromise the performance of the system. Have your vehicle checked immediately.



E170684

To avoid fluid contamination, the reservoir cap must remain in place and fully tight, unless you are adding fluid.

Only use fluid that meets Ford specifications. See **Capacities and Specifications** (page 271).

CLUTCH FLUID CHECK

The clutch and brake systems share the same fluid reservoir. See **Brake Fluid Check** (page 221).

POWER STEERING FLUID CHECK

Your vehicle is equipped with an electric power steering (EPS) system. There is no fluid reservoir to check or fill.

Maintenance

WASHER FLUID CHECK

WARNING



If you operate your vehicle in temperatures below 40°F (5°C), use washer fluid with antifreeze protection. Failure to use washer fluid with antifreeze protection in cold weather could result in impaired windshield vision and increase the risk of injury or accident.

Add fluid to fill the reservoir if the level is low. Only use a washer fluid that meets Ford specifications. See **Capacities and Specifications** (page 271).

State or local regulations on volatile organic compounds may restrict the use of methanol, a common windshield washer antifreeze additive. Washer fluids containing non-methanol antifreeze agents should be used only if they provide cold weather protection without damaging the vehicle's paint finish, wiper blades or washer system.

FUEL FILTER

Your vehicle is equipped with a lifetime fuel filter that is integrated with the fuel tank. Regular maintenance or replacement is not needed.

CHANGING THE 12V BATTERY

WARNINGS



Batteries normally produce explosive gases which can cause personal injury. Therefore, do not allow flames, sparks or lighted substances to come near the battery. When working near the battery, always shield your face and protect your eyes. Always provide correct ventilation.

WARNINGS



When lifting a plastic-cased battery, excessive pressure on the end walls could cause acid to flow through the vent caps, resulting in personal injury and damage to the vehicle or battery. Lift the battery with a battery carrier or with your hands on opposite corners.



Keep batteries out of reach of children. Batteries contain sulfuric acid. Avoid contact with skin, eyes or clothing. Shield your eyes when working near the battery to protect against possible splashing of acid solution. In case of acid contact with skin or eyes, flush immediately with water for a minimum of 15 minutes and get prompt medical attention. If acid is swallowed, call a physician immediately.



Battery posts, terminals and related accessories contain lead and lead compounds. Wash hands after handling.



This vehicle may be fitted with more than one battery. Removing the battery cables from only one battery does not disconnect your vehicle electrical system. Make sure you disconnect the battery cables from all batteries when disconnecting power. Failure to do so may cause serious personal injury or property damage.

Your vehicle is fitted with a Motorcraft maintenance-free battery which normally does not require additional water.

When a battery replacement is required, you must use a recommended replacement battery that matches the electrical requirements of the vehicle.

Note: *After cleaning or replacing the battery, make sure you reinstall the battery cover or shield.*

Maintenance

Note: *If you add electrical accessories or components to the vehicle, it may adversely affect the low voltage battery performance and durability. This may also affect the performance of other electrical systems in the vehicle.*

For longer, trouble-free operation, keep the top of the battery clean and dry.

If you see any corrosion on the battery or terminals, remove the cables from the terminals and clean with a wire brush. You can neutralize the acid with a solution of baking soda and water.

Because your vehicle's engine is electronically controlled by a computer, some control conditions are maintained by power from the battery. When the battery is disconnected or a new battery is installed, the engine must relearn its idle and fuel trim strategy for optimum driveability and performance. Flexible fuel vehicles (FFV) must also relearn the ethanol content of the fuel for optimum driveability and performance.

To restore the settings, do the following:

1. Apply the parking brake.
2. Shift into park (P) or neutral (N).
3. Switch off all accessories.
4. Press the brake pedal and start your vehicle.
5. Run the engine until it reaches normal operating temperature. While the engine is warming up, complete the following: Reset the clock. See **Audio System** (page 293). Reset the power windows bounce-back feature. See **Windows and Mirrors** (page 73). Reset the radio station presets. See **Audio System** (page 293).
6. Allow the engine to idle for at least one minute.

7. Drive the vehicle at least 10 mi (16 km) to completely relearn the idle trim and fuel trim strategy.

Note: *If you do not allow the engine to relearn the idle and fuel trim strategy, the idle quality of your vehicle may be adversely affected until the engine computer eventually relearns the idle trim and fuel trim strategy.*

Note: *For flexible fuel vehicles, if you are operating on E85, you may experience poor starts or an inability to start the engine and driveability problems until the fuel trim and ethanol content have been relearned.*

Make sure that you dispose of old batteries in an environmentally friendly way. Seek advice from your local authority about recycling old batteries.

If storing your vehicle for more than 30 days without recharging the battery, we recommend that you disconnect the battery cables to maintain battery charge for quick starting.

Battery Management System (if Equipped)

The battery management system monitors battery conditions and takes actions to extend battery life. If excessive battery drain is detected, the system temporarily disables some electrical systems to protect the battery.

Systems included are:

- Heated rear window.
- Heated seats.
- Climate control.
- Heated steering wheel.
- Audio unit.
- Navigation system.

Maintenance

A message may appear in the information displays to alert you that battery protection actions are active. These messages are only for notification that an action is taking place, and not intended to indicate an electrical problem or that the battery requires replacement.

After battery replacement, or in some cases after charging the battery with an external charger, the battery management system requires eight hours of vehicle sleep time to relearn the battery state of charge. During this time your vehicle must remain fully locked with the ignition switched off.

Note: *Prior to relearning the battery state of charge, the battery management system may temporarily disable some electrical systems.*

Electrical Accessory Installation

To make sure the battery management system works correctly, do not connect an electrical device ground connection directly to the battery negative post. This can cause inaccurate measurements of the battery condition and potential incorrect system operation.

Note: *If you add electrical accessories or components to the vehicle, it may adversely affect battery performance and durability. This may also affect the performance of other electrical systems in the vehicle.*

CHECKING THE WIPER BLADES



E142463

Run the tip of your fingers over the edge of the blade to check for roughness.

Clean the wiper blades with washer fluid or water applied with a soft sponge or cloth.

CHANGING THE WIPER BLADES

1. Pull the wiper blade and arm away from the glass and press the locking buttons together.

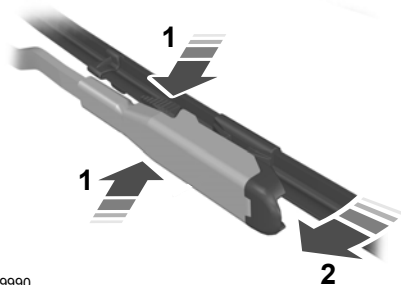

E129990

2. Rotate and remove the wiper blade.
3. Attach the new blade to the arm and snap it into place.

Replace wiper blades at least once per year for optimum performance.

Poor wiper quality can be improved by cleaning the wiper blades and the windshield. See **Cleaning the Windows and Wiper Blades** (page 233).

ADJUSTING THE HEADLAMPS

Vertical Aim Adjustment

The headlamps on your vehicle are properly aimed at the assembly plant. If your vehicle has been in an accident, have the alignment of your headlamps checked by an authorized dealer.

Maintenance

Headlamp Aiming Target

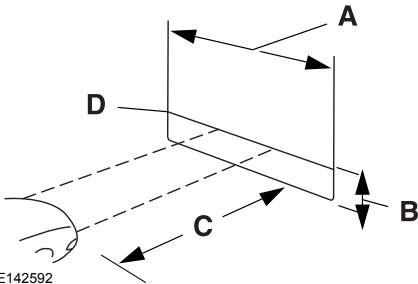

E142592

- A 8 feet (2.4 meters)
- B Center height of lamp to ground
- C 25 feet (7.6 meters)
- D Horizontal reference line

Vertical Aim Adjustment

1. Park the vehicle directly in front of a wall or screen on a level surface, approximately 25 feet (7.6 meters) away.
2. Measure the height from the center of your headlamp (indicated by a 3.0 millimeter circle on the lens) to the ground and mark an 8 foot (2.4 meter) horizontal reference line on the vertical wall or screen at this height (a piece of masking tape works well).

Note: To see a clearer light pattern for adjusting, you may want to block the light from one headlamp while adjusting the other.

3. Turn on the low beam headlamps to illuminate the wall or screen and open the hood. Cover one of the headlamps so no light hits the wall.



E142465

4. There is a distinct cut-off (change from light to dark) in the left portion of the beam pattern. Position the top edge of this cut-off 3 inches (7.5 centimeters) below the horizontal reference line.

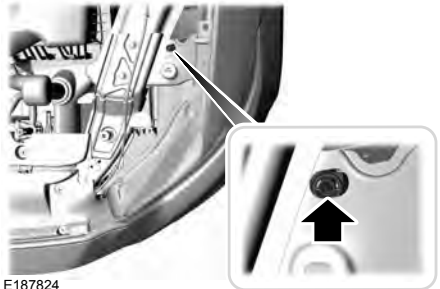

E187824

5. Locate the vertical adjuster on each headlamp. Use a Phillips #2 screwdriver to turn the adjuster either clockwise or counterclockwise to adjust the vertical aim of the headlamp.
6. Repeat Steps 3 through 7 to adjust the other headlamp.
7. Close the hood and turn off the lamps.

Horizontal Aim Adjustment

The horizontal aim does not require any adjustment for this vehicle. If a fault occurs, have the system checked by an authorized dealer.

Maintenance

CHANGING A BULB

Lamp Assembly Condensation

Exterior lamps have vents to accommodate normal changes in pressure. Condensation can be a natural occurrence of this design. When moist air enters the lamp assembly through the vents, there is a possibility that condensation can occur in cold temperatures. When normal condensation occurs, a thin film of mist can form on the interior of the lens. The mist eventually clears and exits through the vents during normal operation. Clearing time may take as long as 48 hours under dry weather conditions.

Examples of acceptable condensation are:

- Thin mist without streaks, drip marks or droplets.
- Fine mist that covers less than 50% of the lens.

Examples of unacceptable moisture are:

- Water puddle inside the lamp.
- Large water droplets, drip marks or streaks on the interior of the lens.

If any of the above conditions of unacceptable moisture are present, contact an authorized.

Replacing HID Headlamp Bulbs

Your vehicle has high intensity discharge lamps. These lamps operate at a high voltage. Contact an authorized dealer.

Accessing the Direction Indicator and Fog Lamp Bulbs

1. Rotate the steering wheel to the opposite side of the bulb needing replacement.

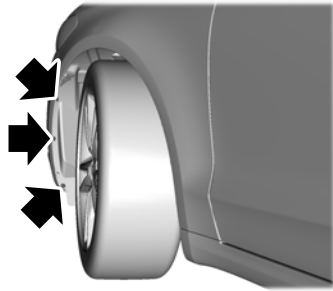

E159695

2. Remove the three wheel liner fasteners.



E176616

3. Locate the most outside fastener attaching the front fascia to the wheel liner and remove it.
4. Pull the wheel liner back toward the tire to gain access to the bulbs.

Maintenance

Replacing the Direction Indicator Bulbs



E180889

1. Remove the bulb holder from the lamp assembly by turning it counterclockwise.
2. Disconnect the electrical connector.
3. Remove the bulb from the bulb holder by pulling it straight out.

Replacing Fog Lamp Bulbs (If Equipped)

1. Make sure the lighting control is in the off position.
2. Disconnect the electrical connector from the bulb by pulling it straight off.



E174588

3. Rotate the bulb counterclockwise and remove from the fog lamp assembly.
4. Install the bulb in reverse order.

Replacing LED Fog Lamp Bulbs (If Equipped)

These lamps have LED bulbs. Contact an authorized dealer.

Replacing Reverse Lamp Bulbs

1. Make sure the lighting control is in the off position.
2. Locate the reverse lamp bulb under the rear bumper of your vehicle. To access the bulb, reach behind the bumper.
3. Disconnect the electrical sensor from the bulb by pulling it straight off.

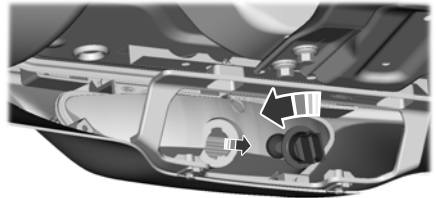

E177487

4. Rotate the bulb counterclockwise and remove it from the reverse lamp assembly.

Replacing rear, Brake, High-Mount Brake, Rear Direction Indicator and License Plate Lamp Bulbs

These lamps have LED bulbs. Contact an authorized dealer.

Maintenance

BULB SPECIFICATION CHART

Replacement bulbs are specified in the chart below. Headlamp bulbs must be marked with an authorized "D.O.T." for North America and an "E" for Europe to

make sure lamp performance, light brightness and pattern and safe visibility. The correct bulbs do not damage the lamp assembly or void the lamp assembly warranty and provide quality bulb illumination time.

Function	Trade name
Headlamps - high intensity discharge (HID)*	D3S
Front park and Direction indicators	7444NA (amber)
Sidemarkers	WY5W (amber)
Fog lamp	LED
	H11
Rear lamp, brake lamp and direction indicator lamp*	LED
High-mount brake lamp*	LED
Backup lamp	3156 or 3157
License plate lamp*	LED
Dome and Map lamp	W5W
Glove box and Cargo lamp	W5W
To replace all instrument panel lights, contact an authorized dealer	
* Contact an authorized dealer to replace the bulb.	

Maintenance

CHANGING THE ENGINE AIR FILTER

WARNING



To reduce the risk of vehicle damage and personal burn injuries, do not start your engine with the air cleaner removed and do not remove it while the engine is running.

Note: Failure to use the correct air filter element may result in severe engine damage. Your warranty may not cover these damages.

Use only the air filter element listed when changing the air filter element. See **Motorcraft Parts** (page 273).

Change the air filter element at the proper intervals. See **Scheduled Maintenance** (page 422).

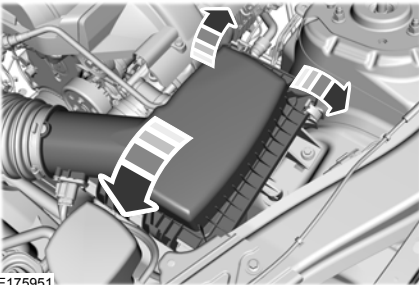

1. Release the two clamps that secure the air filter housing cover.
2. Carefully lift the air filter housing cover.
3. Remove the air filter element from the air filter housing.
4. Wipe any dirt or debris from the air filter housing and cover to make sure no dirt gets in the engine and that you have a good seal.

5. Install a new air filter element. Be careful not to crimp the filter element edges between the air filter housing and cover. This could cause filter damage and allow unfiltered air to enter the engine if it is not properly seated.
6. Replace the air filter housing cover.
7. Engage the clamps to secure the air filter housing cover to the air filter housing.

Vehicle Care

GENERAL INFORMATION

Your dealer has many quality products available to clean your vehicle and protect its finishes.

Materials

Name	Specification
Motorcraft® Bug and Tar Remover (U.S.) Motorcraft® Bug and Tar Remover / Dissolvant de goudron et éliminateur d'insectes (Canada) ZC-42 (U.S. & Canada)	-
Motorcraft® Custom Bright Metal Cleaner (U.S.) Custom Bright Metal Cleaner / Nettoyant pour métal brillant (Canada) ZC-15 (U.S. & Canada)	-
Motorcraft® Detail Wash (U.S.) Detail Wash / Shampooing superfin (Canada) ZC-3-A (U.S. & Canada)	ESR-M14P4-A
Motorcraft® Engine Shampoo and Degreaser Engine Shampoo and Degreaser ZC-20 (U.S.)	-
Engine Shampoo Engine Shampoo / Shampooing pour moteur (Canada) CXC-66-A (Canada)	-
Motorcraft® Leather and Vinyl Cleaner (U.S.) Premium Leather and Vinyl Cleaner / Nettoyant pour cuir et vinyle de haute qualité (Canada) ZC-56 (U.S. & Canada)	-
Multi-Purpose Cleaner Multi-Purpose Cleaner / Nettoyant multi-usage (Canada) CXC-101 (Canada)	-
Motorcraft® Premium Windshield Wash Concentrate with Bitterant (U.S.) Premium Quality Windshield Washer Fluid / Liquide lave-glace de haute qualité (Canada) ZC-32-B2 (U.S.) CXC-37-A/B/D/F (Canada)	WSS-M14P19-A
Professional Strength Carpet and Upholstery Cleaner (U.S.) Professional Strength Carpet & Upholstery Cleaner / Nettoyant professionnel pour sellerie et moquette (Canada) ZC-54 (U.S. & Canada)	-
Motorcraft® Spot and Stain Remover Spot and Stain Remover ZC-14 (U.S.)	-
Motorcraft® Ultra-Clear Spray Glass Cleaner (U.S.)	ESR-M14P5-A

CLEANING PRODUCTS

For best results, use the following products or products of equivalent quality:

Vehicle Care

Name	Specification
Premium Glass Cleaner / Nettoie-vitres de qualité supérieure (Canada) ZC-23 (U.S.) CXC-100 (Canada)	
Motorcraft® Wheel and Tire Cleaner (U.S.) Wheel and Tire Cleaner / Nettoyant pour roues et pneus (Canada) ZC-37-A (U.S. & Canada)	-

CLEANING THE EXTERIOR

Wash your vehicle regularly with cool or lukewarm water and a neutral pH shampoo, we recommend Motorcraft Detail Wash.

- Never use strong household detergents or soap, for example dish washing or laundry liquid. These products can discolor and spot painted surfaces.
- Never wash your vehicle when it is hot to the touch, or during strong or direct sunlight.
- Dry your vehicle with a chamois or soft terry cloth towel to eliminate water spotting.
- Immediately remove fuel spillages, bird droppings, insect deposits and road tar. These may cause damage to your vehicle's paintwork or trim over time. We recommend Motorcraft Bug and Tar Remover.
- Remove any exterior accessories, for example antennas, before entering a car wash.

Note: *Suntan lotions and insect repellents can damage painted surfaces. If these substances come in contact with your vehicle, wash the affected area as soon as possible.*

Exterior Chrome Parts

- Apply a high quality-cleaning product to bumpers and other chrome parts. Follow the manufacturer's instructions. We recommend Motorcraft Custom Bright Metal Cleaner.
- Do not apply the cleaning product to hot surfaces. Do not leave the cleaning product on chrome surfaces longer than the time recommended.
- Using other non-recommended cleaners can result in severe and permanent cosmetic damage.

Note: *Never use abrasive materials, for example steel wool or plastic pads as they can scratch the chrome surface.*

Note: *Do not use chrome cleaner, metal cleaner or polish on wheels or wheel covers.*

Exterior Plastic Parts

For routine cleaning we recommend Motorcraft Detail Wash. If tar or grease spots are present, we recommend Motorcraft Bug and Tar Remover.

Stripes or Graphics (If Equipped)

Hand washing your vehicle is preferred however, pressure washing may be used under the following conditions:

- Do not use water pressure higher than 2,000 psi (14,000 kPa).
- Do not use water hotter than 179°F (82°C).

Vehicle Care

- Use a spray with a 40° wide spray angle pattern.
- Keep the nozzle at a 12 in (305 mm) distance and 90° angle to your vehicle's surface.

Note: *Holding the pressure washer nozzle at an angle to the vehicle's surface may damage graphics and cause the edges to peel away from the vehicle's surface.*

Underbody

Flush the complete underside of your vehicle frequently. Keep body and door drain holes free of debris or foreign material.

Under Hood

For removing black rubber marks from under the hood we recommend Motorcraft Wheel and Tire Cleaner or Motorcraft Bug and Tar Remover.

WAXING

Regular waxing is necessary to protect your car's paint from the elements. We recommend that you wash and wax the painted surface once or twice a year.

When washing and waxing, park your vehicle in a shaded area out of direct sunlight. Always wash your vehicle before applying wax.

- Use a quality wax that does not contain abrasives.
 - Follow the manufacturer's instructions to apply and remove the wax.
 - Apply a small amount of wax in a back-and-forth motion, not in circles.
- Do not allow wax to come in contact with any non-body (low-gloss black) colored trim. The wax will discolor or stain the parts over time.
 - Roof racks.
 - Bumpers.
 - Grained door handles.
 - Side moldings.
 - Mirror housings.
 - Windshield cowl area.
 - Do not apply wax to glass areas.
 - After waxing, your car's paint should feel smooth, and be free of streaks and smudges.

CLEANING THE ENGINE

Engines are more efficient when they are clean because grease and dirt buildup keep the engine warmer than normal.

When washing:

- Take care when using a power washer to clean the engine. The high-pressure fluid could penetrate the sealed parts and cause damage.
- Do not spray a hot engine with cold water to avoid cracking the engine block or other engine components.
- Spray Motorcraft Engine Shampoo and Degreaser on all parts that require cleaning and pressure rinse clean. In Canada, use Motorcraft Engine Shampoo.
- Never wash or rinse the engine while it is hot or running; water in the running engine may cause internal damage.

Vehicle Care

- Never wash or rinse any ignition coil, spark plug wire or spark plug well, or the area in and around these locations.
- Cover the battery, power distribution box, and air filter assembly to prevent water damage when cleaning the engine.

CLEANING THE WINDOWS AND WIPER BLADES

Car wash chemicals and environmental fallout can result in windshield and wiper blade contamination. Dirty windshield and wipers will result in poor windshield wiper operation. Keep the windshield and wiper blades clean to maintain windshield wiper performance.

To clean the windshield and wiper blades:

- Clean the windshield with a non-abrasive glass cleaner. When cleaning the interior of the windshield, avoid getting any glass cleaner on the instrument panel or door panels. Wipe any glass cleaner off these surfaces immediately.
- For windshields contaminated with tree sap, chemicals, wax or bugs, clean the entire windshield using steel wool (no greater than 0000 grade) in a circular motion and rinse with water.
- Clean the wiper blades with isopropyl rubbing alcohol or windshield washer concentrate.

Note: *Do not use razor blades or other sharp objects to clean or remove decals from the inside of the heated rear window. The vehicle warranty does not cover damage caused to the heated rear window grid lines.*

CLEANING THE INTERIOR

WARNINGS



Do not use cleaning solvents, bleach or dye on the vehicle's safety belts, as these actions may weaken the belt webbing.



On vehicles equipped with seat-mounted airbags, do not use chemical solvents or strong detergents. Such products could contaminate the side airbag system and affect performance of the side airbag in a collision.

For fabric, carpets, cloth seats, safety belts and seats equipped with side airbags:

- Remove dust and loose dirt with a vacuum cleaner.
- Remove light stains and soil with Motorcraft Professional Strength Carpet & Upholstery Cleaner.
- If grease or tar is present on the material, spot-clean the area first with Motorcraft Spot and Stain Remover. In Canada, use Motorcraft Multi-Purpose Cleaner.
- If a ring forms on the fabric after spot cleaning, clean the entire area immediately (but do not oversaturate) or the ring will set.
- Do not use household cleaning products or glass cleaners, which can stain and discolor the fabric and affect the flame retardant abilities of the seat materials.

Vehicle Care

CLEANING THE INSTRUMENT PANEL AND INSTRUMENT CLUSTER LENS

WARNING



Do not use chemical solvents or strong detergents when cleaning the steering wheel or instrument panel to avoid contamination of the airbag system.

Note: Follow the same procedure as cleaning leather seats for cleaning leather instrument panels and leather interior trim surfaces. See **Cleaning Leather Seats** (page 234).

Clean the instrument panel and cluster lens with a clean, damp and soft cloth, then use a clean, dry and soft cloth to dry these areas.

- Avoid cleaners or polishes that increase the gloss of the upper portion of the instrument panel. The dull finish in this area helps protect you from undesirable windshield reflection.
- Do not use any household cleaning products or glass cleaners as these may damage the finish of the instrument panel, interior trim and cluster lens.
- Wash or wipe your hands clean if you have been in contact with certain products such as insect repellent and suntan lotion to avoid possible damage to the interior painted surfaces.
- Do not allow air fresheners and hand sanitizers to spill onto interior surfaces. If a spill occurs, wipe off immediately. Your warranty may not cover these damages.

If a staining liquid like coffee or juice has been spilled on the instrument panel or on interior trim surfaces:

1. Wipe up spilled liquid using a clean, soft cloth as quickly as possible.
2. Use Motorcraft Premium Leather and Vinyl Cleaner or a commercially available leather cleaning product for automotive interiors. Test any cleaner or stain remover on an inconspicuous area.
3. Alternatively, wipe the surface with a clean, soft cloth and a mild soap and water solution. Dry the area with a clean, soft cloth.
4. If necessary, apply more soap and water solution or cleaning product to a clean, soft cloth and press it onto the soiled area. Allow this to set at room temperature for 30 minutes.
5. Remove the soaked cloth, then with a clean, damp cloth, use a rubbing motion for 60 seconds on the soiled area.
6. Dry the area with a clean, soft cloth.

CLEANING LEATHER SEATS (if Equipped)

Note: Follow the same procedure as cleaning leather seats for cleaning leather instrument panels and leather interior trim surfaces.

For routine cleaning, wipe the surface with a soft, damp cloth and a mild soap and water solution. Dry the area with a clean, soft cloth.

For cleaning and removing stains such as dye transfer, use Motorcraft Premium Leather and Vinyl Cleaner or a commercially available leather cleaning product for automotive interiors.

Note: Test any cleaner or stain remover on an inconspicuous area.

Vehicle Care

You should:

- Remove dust and loose dirt with a vacuum cleaner.
- Clean and treat spills and stains as soon as possible.

Do not use the following products as these may damage the leather:

- Oil and petroleum or silicone-based leather conditioners.
- Household cleaners.
- Alcohol solutions.
- Solvents or cleaners intended specifically for rubber, vinyl and plastics.

REPAIRING MINOR PAINT DAMAGE

Authorized dealers have touch-up paint to match your vehicle's color. Your vehicle color code is printed on a sticker on the front, left-hand side door jamb. Take your color code to your authorized dealer to make sure you get the correct color.

Before repairing minor paint damage, use a cleaner such as Motorcraft Bug and Tar Remover to remove particles such as bird droppings, tree sap, insect deposits, tar spots, road salt and industrial fallout.

Always read the instructions before using cleaning products.

CLEANING THE WHEELS (If

Equipped)

Note: Do not apply a cleaning chemical to warm or hot wheel rims and covers.

Note: Some automatic car washes may cause damage to the finish on your wheel rims and covers.

Note: Industrial-strength or heavy-duty cleaners in combination with brush agitation to remove brake dust and dirt, could wear away the clear coat finish over a period time.

Note: Do not use hydrofluoric acid-based or high caustic-based wheel cleaners, steel wool, fuels or strong household detergents.

Note: If you intend parking your vehicle for an extended period after cleaning the wheels with a wheel cleaner, drive your vehicle for a few minutes before doing so. This will reduce the risk of increased corrosion of the brake discs.

Alloy wheels and wheel covers are coated with a clear coat paint finish. To maintain their condition we recommend that you:

- Clean the wheels weekly using Motorcraft Wheel and Tire Cleaner. Apply using manufacturer's instructions.
- Use a sponge to remove heavy deposits of dirt and brake dust accumulation.
- Rinse thoroughly with a strong stream of water when you have completed the cleaning process.
- To remove tar and grease, use Motorcraft Bug and Tar Remover.

VEHICLE STORAGE

If you plan on storing your vehicle for 30 days or more, read the following maintenance recommendations to make sure your vehicle stays in good operating condition.

We engineer and test all motor vehicles and their components for reliable, regular driving. Under various conditions, long-term storage may lead to degraded engine performance or failure unless you use specific precautions to preserve engine components.

Vehicle Care

General

- Store all vehicles in a dry, ventilated place.
- Protect from sunlight, if possible.
- If vehicles are stored outside, they require regular maintenance to protect against rust and damage.

Body

- Wash your vehicle thoroughly to remove dirt, grease, oil, tar or mud from exterior surfaces, rear-wheel housing and the underside of front fenders.
- Periodically wash your vehicle if it is stored in exposed locations.
- Touch-up exposed or primed metal to prevent rust.
- Cover chrome and stainless steel parts with a thick coat of auto wax to prevent discoloration. Re-wax as necessary when you wash your vehicle.
- Lubricate all hood, door and luggage compartment hinges and latches with a light grade oil.
- Cover interior trim to prevent fading.
- Keep all rubber parts free from oil and solvents.

Engine

- Change the engine oil and filter prior to storage because used engine oil contains contaminants which may cause engine damage.
- Start the engine every 15 days for a minimum of 15 minutes. Run at fast idle with the climate controls set to defrost until the engine reaches normal operating temperature.

- With your foot on the brake, shift through all the gears while the engine is running.
- We recommend that you change the engine oil before you use your vehicle again.

Fuel system

- Fill the fuel tank with high-quality fuel until the first automatic shutoff of the fuel pump nozzle.

Cooling system

- Protect against freezing temperatures.
- When removing your vehicle from storage, check coolant fluid level. Confirm that there are no cooling system leaks and that fluid is at the recommended level.

Battery

- Check and recharge as necessary. Keep connections clean.
- If storing your vehicle for more than 30 days without recharging the battery, we recommend that you disconnect the battery cables to maintain battery charge for quick starting.

Note: *It is necessary to reset memory features if battery cables are disconnected.*

Brakes

- Make sure the brakes and parking brake release fully.

Tires

- Maintain recommended air pressure.

Vehicle Care

Miscellaneous

- Make sure all linkages, cables, levers and pins under your vehicle are covered with grease to prevent rust.
- Move vehicles at least 25 ft (7.5 m) every 15 days to lubricate working parts and prevent corrosion.

Removing Vehicle From Storage

When your vehicle is ready to come out of storage, do the following:

- Wash your vehicle to remove any dirt or grease film build-up on window surfaces.
- Check windshield wipers for any deterioration.
- Check under the hood for any foreign material that may have collected during storage such as mice or squirrel nests.
- Check the exhaust for any foreign material that may have collected during storage.
- Check tire pressures and set tire inflation per the Tire Label.
- Check brake pedal operation. Drive your vehicle 15 ft (4.5 m) back and forth to remove rust build-up.
- Check fluid levels (including coolant, oil and gas) to make sure there are no leaks, and fluids are at recommended levels.
- If you remove the battery, clean the battery cable ends and check for damage.

Contact an authorized dealer if you have any concerns or issues.

CLEANING THE CONVERTIBLE TOP

Remove lint with a lint roller or a vacuum with a soft bristle brush.

For cloth and vinyl tops, wash with an approved high-quality convertible top cleaner and protectant.

Note: *Do not use stiff bristle brushes, abrasive materials or household cleaning products.*

Note: *High-pressure water may cause water leaks and possible seal damage to the convertible top.*

Note: *Do not fold the convertible top when it is wet.*

Note: *Avoid hot wax on vinyl materials during car washes.*

Wheels and Tires

TIRE SEALANT AND INFLATOR KIT (If Equipped)

Note: The temporary mobility kit contains enough sealant compound in the canister for one tire repair only. See an authorized Ford dealer for replacement sealant canisters.

The kit is located under the load floor in the trunk. The kit consists of an air compressor to re-inflate the tire and a canister of sealing compound that will effectively seal most punctures caused by nails or similar objects. This kit provides a temporary tire repair, allowing you to drive your vehicle up to 120 mi (200 km) at a maximum speed of 50 mph (80 km/h) to reach a tire service location.

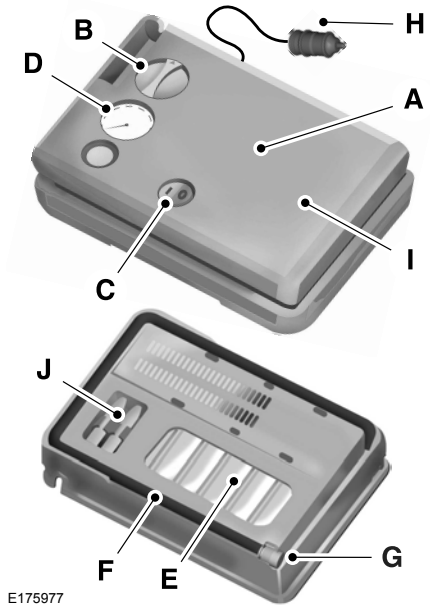

- A Air compressor (inside).
- B Selector switch.
- C On and off button.
- D Air pressure gauge.
- E Sealant bottle and canister.
- F Dual purpose hose: air and repair.
- G Tire valve connector.
- H Accessory power plug.
- I Casing/housing.
- J Bike/raft/sports ball adapters.

Wheels and Tires

General Information

WARNING



Failure to follow these guidelines could result in an increased risk of loss of vehicle control, injury or death.

Note: Do not use the kit if you have severely damaged a tire. Only seal punctures located within the tire tread with the kit.

Do not attempt to repair punctures larger than ¼ inch (6 millimeters) or damage to the tire's sidewall. The tire may not completely seal.

Loss of air pressure may adversely affect tire performance. For this reason:

Note: Do not drive the vehicle above 50 mph (80 km/h).

Note: Do not drive further than 120 mi (200 km). Drive only to the closest authorized Ford dealer or tire repair shop to have your tire inspected.

- Drive carefully and avoid abrupt steering maneuvers.
- Periodically monitor tire inflation pressure in the affected tire; if the tire is losing pressure, have the vehicle towed.
- Read the information in the Tips for Use of the Kit section to make sure safe operation of the kit and your vehicle.

Tips for Use of the Kit

To ensure safe operation of the kit:

- Read all instructions and cautions fully.
- Before operating the kit, make sure your vehicle is safely off the road and away from moving traffic. Switch on the hazard lights.
- Always set the parking brake to ensure the vehicle does not move unexpectedly.

- Do not remove any foreign objects, such as nails or screws, from the tire.
- When using the kit, leave the engine running (only if the vehicle is outdoors or in a well-ventilated area) so the compressor does not drain the vehicle's battery.
- Do not allow the compressor to operate continuously for more than 15 minutes. This will help prevent the compressor from overheating.
- Never leave the kit unattended during operation.
- Sealant compound contains latex. Those with latex sensitivities should use appropriate precautions to avoid an allergic reaction.
- Keep the kit away from children.
- Only use the kit when the ambient temperature is between -22°F (-30°C) and 158°F (70°C).
- Only use the sealing compound before the use-by date. The use-by date is on a label on the sealant canister, which you can see through the rectangular viewing window on the bottom of the compressor. Check the use-by date regularly and replace the canister after four years of non-use.
- Do not store the kit unsecured inside the passenger compartment of the vehicle as it may cause injury during a sudden stop or crash. Always store the kit in its original location.
- After sealant use, an authorized Ford dealer must replace the tire pressure monitoring system sensor and valve stem on the wheel.
- Operating the kit could cause an electrical disturbance in radio, CD and DVD player operation.

Wheels and Tires



* When inflation only is required for a tire or other objects, the selector must be in the Air position.



What to do When a Tire Is Punctured

You can repair a tire puncture within the tire's tread area in two stages with the kit.

- In the first stage, inflate the tire with a sealing compound and air. After you inflate the tire, you will need to drive the vehicle a short distance (about 4 miles [6 kilometers]) to distribute the sealant in the tire.
- In the second stage, check the tire pressure and adjust, if necessary, to the vehicle's specified tire inflation pressure.

First Stage: Inflating the Tire with Sealing Compound and Air

WARNINGS

-  Do not stand directly over the kit while inflating the tire. If you notice any unusual bulges or deformations in the tire's sidewall during inflation, stop and call roadside assistance.
-  If the tire does not inflate to the recommended tire pressure within 15 minutes, stop and call roadside assistance.
-  Do not run the engine during kit operation unless the vehicle is outdoors or in a well-ventilated area.

Preparation: Park the vehicle in a safe, level and secure area, away from moving traffic.

Switch the hazard lights on. Apply the parking brake and switch the engine off. Inspect the flat tire for visible damage.

Sealant compound contains latex. Use appropriate precautions to avoid any allergic reactions.

Do not remove any foreign object that has pierced the tire. If a puncture is located in the tire sidewall, stop and call roadside assistance.

1. Remove the valve cap from the tire valve.
2. Unwrap the dual purpose hose (black tube) from the back of the compressor housing.
3. Fasten the hose to the tire valve by turning the connector clockwise. Tighten the connection securely.



E200523

4. Plug the power cable into the 12-volt power point in the vehicle.
5. Remove the warning sticker found on the casing/housing and place it on the top of the instrument panel or the center of the dash.
6. Start the vehicle and leave the engine running so the compressor does not drain the vehicle's battery.

Wheels and Tires

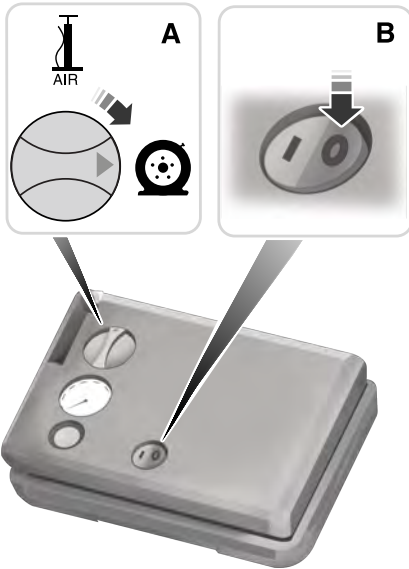

E175981

7. Turn dial (A) clockwise to the sealant position. Switch the kit on by pressing the on/off button (B).
8. Inflate the tire to the pressure listed on the tire label located on the driver's door or the door jamb area. The initial air pressure gauge reading may indicate a value higher than the label pressure while you pump the sealing compound into the tire. This is normal and should be no reason for concern. The pressure gauge reading will indicate the tire inflation pressure after about 30 seconds of operation. You should check the final tire pressure with the compressor turned OFF in order to get an accurate pressure reading.

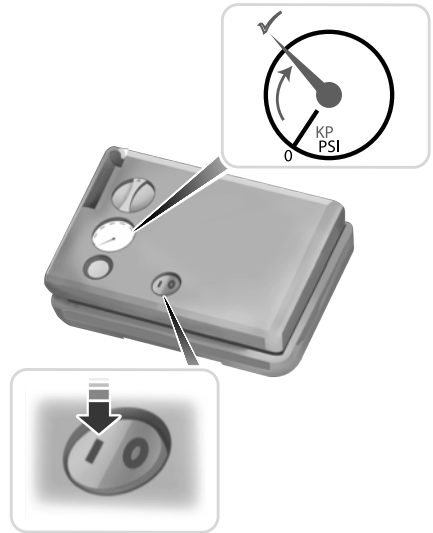

E175982

9. When the tire reaches the recommended tire pressure, switch off the kit, unplug the power cable, and disconnect the hose from the tire valve. Re-install the valve cap on the tire valve and return the kit to the stowage area.
10. Immediately and cautiously, drive the vehicle 4 miles (6 kilometers) to distribute the sealant evenly inside the tire. Do not exceed 50 mph (80 km/h).
11. After 4 miles (6 kilometers), stop and check the tire pressure. See Second Stage: Checking Tire Pressure.

Wheels and Tires

Note: *If you experience any unusual vibration, ride disturbance or noise while driving, reduce your speed until you can safely pull off to the side of the road to call for roadside assistance. Note: Do not proceed to the second stage of this operation.*

Second Stage: Checking Tire Pressure

WARNINGS



If you are proceeding from the First Stage: Re-inflating the Tire with Sealing Compound and Air section and have injected sealant in the tire and the pressure is below 20 psi (1.4 bar), continue to the next step.



The power plug may get hot after use and should be handled carefully while unplugging.

Check the air pressure of your tires as follows:



E175983

1. Remove the valve cap from the tire valve.
2. Firmly screw the air compressor hose onto the valve stem by turning clockwise.
3. Push and turn the dial clockwise to the air position.

4. If required, switch on the compressor and adjust the tire to the recommended inflation pressure shown on the tire label located on the driver's door or door jamb area. You should check the tire pressure with the compressor turned OFF in order to get an accurate pressure reading.
5. Unplug the hoses, re-install the valve cap on the tire and return the kit to the stowage area.

What to Do After the Tire has Been Sealed

After using the kit to seal your tire, you will need to replace the sealant canister. You can obtain sealant canisters and spare parts at an authorized Ford dealer. You can dispose of empty sealant canisters at home. However, you should dispose of canisters still containing liquid sealant through your local authorized Ford dealer or tire dealer, or in accordance with local waste disposal regulation.

Note: *After you use the sealing compound, the maximum vehicle speed is 50 mph (80 km/h) and the maximum driving distance is 120 mi (200 km). You should inspect the sealed tire immediately.*

You can check the tire pressure any time within the 120 mi (200 km) by performing the steps listed previously in the Second Stage: Checking Tire Pressure procedure.

Wheels and Tires

Removal of the sealant canister from the kit

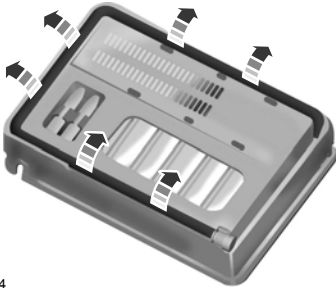

E175984

1. Unwrap the dual purpose hose (black tube) from the compressor housing.

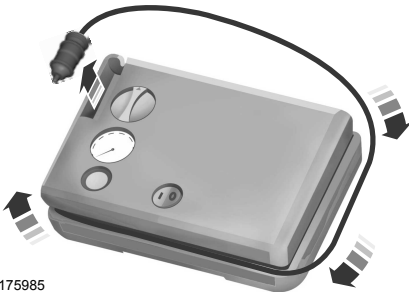

E175985

2. Unwrap the power cord.



E175986

3. Remove the back cover.



E175987

4. Rotate the sealant canister up 90 degrees and pull away from casing/housing to remove.

Installation of the sealant canister to the kit

1. With the canister held perpendicular to the housing, insert the canister nozzle into the connector and push until seated.
2. Rotate the canister 90 degrees down into the housing/casing.



E175988

3. Snap the back cover back into place.

Wheels and Tires



E175989

4. Wrap the dual purpose hose (black tube) around the channel on the bottom of the housing/casing.



E175990

5. Wrap the power cord around the housing and stow the accessory power plug into its storage area.

Note: *If you experience any difficulties with the removal or installation of the sealant canister, consult an authorized Ford dealer for assistance.*

Make sure you check the sealant compound's use-by date regularly. The use-by date is on a label located on the sealant canister, which you can see through the rectangular viewing window on the bottom of the kit. You should replace the sealant canister after four years of non-use.

TIRE CARE

Information About Uniform Tire Quality Grading



E142542

Tire Quality Grades apply to new pneumatic passenger car tires. The Quality grades can be found where applicable on the tire sidewall between tread shoulder and maximum section width. For example: **Treadwear 200 Traction AA Temperature A.**

These Tire Quality Grades are determined by standards that the United States Department of Transportation has set.

Tire Quality Grades apply to new pneumatic passenger car tires. They do not apply to deep tread, winter-type snow tires, space-saver or temporary use spare tires, light truck or LT type tires, tires with nominal rim diameters of 10 to 12 inches or limited production tires as defined in Title 49 Code of Federal Regulations Part 575.104 (c)(2).

Wheels and Tires

U.S. Department of Transportation Tire quality grades: The U.S. Department of Transportation requires Ford Motor Company to give you the following information about tire grades exactly as the government has written it.

Treadwear

The treadwear grade is a comparative rating based on the wear rate of the tire when tested under controlled conditions on a specified government test course. For example, a tire graded 150 would wear 1 ½ times as well on the government course as a tire graded 100. The relative performance of tires depends upon the actual conditions of their use, however, and may depart significantly from the norm due to variations in driving habits, service practices, and differences in road characteristics and climate.

Traction AA A B C

WARNING

 The traction grade assigned to this tire is based on straight-ahead braking traction tests, and does not include acceleration, cornering, hydroplaning or peak traction characteristics.

The traction grades, from highest to lowest are AA, A, B, and C. The grades represent the tire's ability to stop on wet pavement as measured under controlled conditions on specified government test surfaces of asphalt and concrete. A tire marked C may have poor traction performance.

Temperature A B C

WARNING

 The temperature grade for this tire is established for a tire that is properly inflated and not overloaded. Excessive speed, underinflation, or excessive loading, either separately or in combination, can cause heat buildup and possible tire failure.

The temperature grades are A (the highest), B and C, representing the tire's resistance to the generation of heat and its ability to dissipate heat when tested under controlled conditions on a specified indoor laboratory test wheel. Sustained high temperature can cause the material of the tire to degenerate and reduce tire life, and excessive temperature can lead to sudden tire failure. The grade C corresponds to a level of performance which all passenger car tires must meet under the

Wheels and Tires

Federal Motor Vehicle Safety Standard No. 139. Grades B and A represent higher levels of performance on the laboratory test wheel than the minimum required by law.

Glossary of Tire Terminology

***Tire label:** A label showing the original equipment tire sizes, recommended inflation pressure and the maximum weight the vehicle can carry.

***Tire Identification Number (TIN):** A number on the sidewall of each tire providing information about the tire brand and manufacturing plant, tire size and date of manufacture. Also referred to as DOT code.

***Inflation pressure:** A measure of the amount of air in a tire.

***Standard load:** A class of P-metric or Metric tires designed to carry a maximum load at set pressure. For example: For P-metric tires 35 psi (2.4 bar) and for Metric tires 36 psi (2.5 bar). Increasing the inflation pressure beyond this pressure will not increase the tire capability.

***Extra load:** A class of P-metric or Metric tires designed to carry a heavier maximum load at 42 psi (2.9 bar). Increasing the inflation pressure beyond this pressure will not increase the tire's load carrying capability.

***kPa:** Kilopascal, a metric unit of air pressure.

***PSI:** Pounds per square inch, a standard unit of air pressure.

***Cold tire pressure:** The tire pressure when the vehicle has been stationary and out of direct sunlight for an hour or more and prior to the vehicle being driven for 1 mile (1.6 km).

***Recommended inflation pressure:** The cold inflation pressure found on the Safety Compliance Certification Label (affixed to either the door hinge pillar, door-latch post, or the door edge that meets the door-latch post, next to the driver's seating position), or Tire Label located on the B-Pillar or the edge of the driver's door.

***B-pillar:** The structural member at the side of the vehicle behind the front door.

***Bead area of the tire:** Area of the tire next to the rim.

***Sidewall of the tire:** Area between the bead area and the tread.

***Tread area of the tire:** Area of the perimeter of the tire that contacts the road when mounted on the vehicle.

***Rim:** The metal support (wheel) for a tire or a tire and tube assembly upon which the tire beads are seated.

Wheels and Tires

Information Contained on the Tire Sidewall

Both United States and Canada Federal regulations require tire manufacturers to place standardized information on the sidewall of all tires. This information identifies and describes the fundamental characteristics of the tire and also provides a U.S. DOT Tire Identification Number for safety standard certification and in case of a recall.

Information on P Type Tires

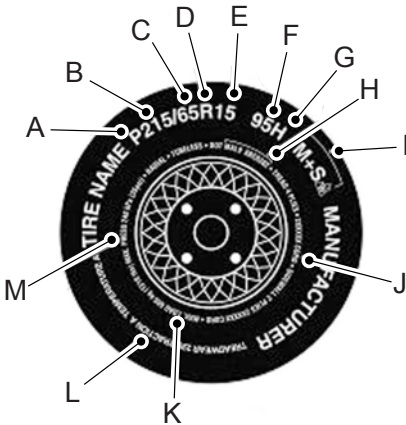

E142543

P215/65R15 95H is an example of a tire size, load index and speed rating. The definitions of these items are listed below. (Note that the tire size, load index and speed rating for your vehicle may be different from this example.)

A. P: Indicates a tire, designated by the Tire and Rim Association, that may be used for service on cars, sport utility vehicles, minivans and light trucks. **Note:** If your tire size does not begin with a letter this may mean it is designated by either the European Tire and Rim Technical Organization or the Japan Tire Manufacturing Association.

B. 215: Indicates the nominal width of the tire in millimeters from sidewall edge to sidewall edge. In general, the larger the number, the wider the tire.

C. 65: Indicates the aspect ratio which gives the tire's ratio of height to width.

D. R: Indicates a radial type tire.

E. 15: Indicates the wheel or rim diameter in inches. If you change your wheel size, you will have to purchase new tires to match the new wheel diameter.

F. 95: Indicates the tire's load index. It is an index that relates to how much weight a tire can carry. You may find this information in your owner's manual. If not, contact a local tire dealer.

Note: You may not find this information on all tires because it is not required by federal law.

Wheels and Tires

G. H: Indicates the tire's speed rating. The speed rating denotes the speed at which a tire is designed to be driven for extended periods of time under a standard condition of load and inflation pressure. The tires on your vehicle may operate at different conditions for load and inflation pressure. These speed ratings may need to be adjusted for the difference in conditions. The ratings range from 81 mph (130 km/h) to 186 mph (299 km/h). These ratings are listed in the following chart.

Note: *You may not find this information on all tires because it is not required by federal law.*

Letter rating	Speed rating - mph (km/h)
M	81 (130)
N	87 (140)
Q	99 (159)
R	106 (171)
S	112 (180)
T	118 (190)
U	124 (200)
H	130 (210)
V	149 (240)

Letter rating	Speed rating - mph (km/h)
W	168 (270)
Y	186 (299)

Note: *For tires with a maximum speed capability over 149 mph (240 km/h), tire manufacturers sometimes use the letters ZR. For those with a maximum speed capability over 186 mph (299 km/h), tire manufacturers always use the letters ZR.*

H. U.S. DOT Tire Identification Number (TIN): This begins with the letters DOT and indicates that the tire meets all federal standards. The next two numbers or letters are the plant code designating where it was manufactured, the next two are the tire size code and the last four numbers represent the week and year the tire was built. For example, the numbers 317 mean the 31st week of 1997. After 2000 the numbers go to four digits. For example, 2501 means the 25th week of 2001. The numbers in between are identification codes used for traceability. This information is used to contact customers if a tire defect requires a recall.

I. M+S or M/S: Mud and Snow, or

AT: All Terrain, or

AS: All Season.

Wheels and Tires

J. **Tire Ply Composition and Material Used:**

Indicates the number of plies or the number of layers of rubber-coated fabric in the tire tread and sidewall. Tire manufacturers also must indicate the ply materials in the tire and the sidewall, which include steel, nylon, polyester, and others.

K. Maximum Load: Indicates the maximum load in kilograms and pounds that can be carried by the tire. See the Safety Compliance Certification Label (affixed to either the door hinge pillar, door-latch post, or the door edge that meets the door-latch post, next to the driver's seating position), for the correct tire pressure for your vehicle.

L. **Treadwear, Traction and Temperature Grades:**

***Treadwear** The treadwear grade is a comparative rating based on the wear rate of the tire when tested under controlled conditions on a specified government test course. For example, a tire graded 150 would wear one and one-half times as well on the government test course as a tire graded 100.

***Traction:** The traction grades, from highest to lowest are AA, A, B, and C. The grades represent the tire's ability to stop on wet pavement as measured under controlled conditions on specified government test surfaces of asphalt and concrete. A tire marked C may have poor traction performance.

***Temperature:** The temperature grades are A (the highest), B and C, representing the tire's resistance to the generation of heat and its ability to dissipate heat when tested under controlled conditions on a specified indoor laboratory test wheel.

M. **Maximum Inflation Pressure:**

Indicates the tire manufacturers' maximum permissible pressure or the pressure at which the maximum load can be carried by the tire. This pressure is normally higher than the vehicle manufacturer's recommended cold inflation pressure which can be found on the Safety Compliance Certification Label (affixed to either the door hinge pillar, door-latch post, or the door edge that meets the door-latch post, next to the driver's seating position), or Tire Label which is located on the B-Pillar or the edge of the driver's door. The cold inflation pressure should never be set lower than the recommended pressure on the vehicle label.

Wheels and Tires

The tire suppliers may have additional markings, notes or warnings such as standard load or radial tubeless.

Additional Information Contained on the Tire Sidewall for LT Type Tires

Note: *Tire Quality Grades do not apply to this type of tire.*

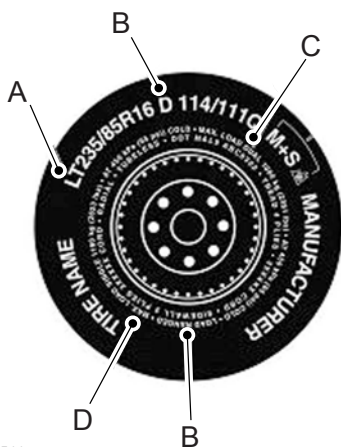

E142544

LT type tires have some additional information beyond those of P type tires; these differences are described below.

A. LT: Indicates a tire, designated by the Tire and Rim Association, that is intended for service on light trucks.

B. Load Range and Load Inflation Limits: Indicates the tire's load-carrying capabilities and its inflation limits.

C. Maximum Load Dual lb (kg) at psi (kPa) cold: Indicates the maximum load and tire pressure when the tire is used as a dual, defined as four tires on the rear axle (a total of six or more tires on the vehicle).

D. Maximum Load Single lb (kg) at psi (kPa) cold: Indicates the maximum load and tire pressure when the tire is used as a single, defined as two tires (total) on the rear axle.

Information on T Type Tires

T145/80D16 is an example of a tire size.

Note: *The temporary tire size for your vehicle may be different from this example. Tire Quality Grades do not apply to this type of tire.*

Wheels and Tires

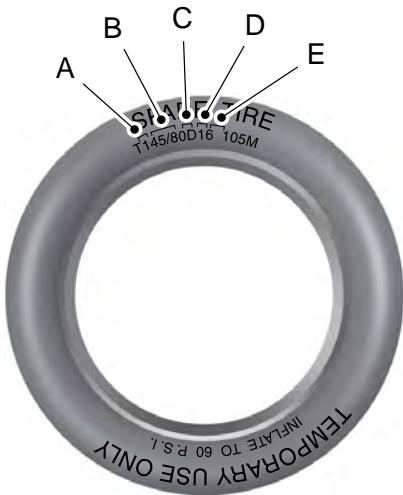

E142545

T type tires have some additional information beyond those of P type tires; these differences are described below:

A. T: Indicates a type of tire, designated by the Tire and Rim Association, that is intended for temporary service on cars, sport utility vehicles, minivans and light trucks.

B. 145: Indicates the nominal width of the tire in millimeters from sidewall edge to sidewall edge. In general, the larger the number, the wider the tire.

C. 80: Indicates the aspect ratio which gives the tire's ratio of height to width. Numbers of 70 or lower indicate a short sidewall.

D. D: Indicates a diagonal type tire.

R: Indicates a radial type tire.

E. 16: Indicates the wheel or rim diameter in inches. If you change your wheel size, you will have to purchase new tires to match the new wheel diameter.

Location of the Tire Label

You will find a Tire Label containing tire inflation pressure by tire size and other important information located on the B-Pillar or the edge of the driver's door.

Inflating Your Tires

Safe operation of your vehicle requires that your tires are properly inflated. Remember that a tire can lose up to half of its air pressure without appearing flat.

Every day before you drive, check your tires. If one looks lower than the others, use a tire gauge to check pressure of all tires and adjust if required.

At least once a month and before long trips, inspect each tire and check the tire pressure with a tire gauge (including spare, if equipped). Inflate all tires to the inflation pressure recommended by Ford Motor Company.

Wheels and Tires

You are strongly urged to buy a reliable tire pressure gauge, as automatic service station gauges may be inaccurate. Ford recommends the use of a digital or dial-type tire pressure gauge rather than a stick-type tire pressure gauge.

Use the recommended cold inflation pressure for optimum tire performance and wear. Under-inflation or over-inflation may cause uneven treadwear patterns.

WARNING



Under-inflation is the most common cause of tire failures and may result in severe tire cracking, tread separation or blowout, with unexpected loss of vehicle control and increased risk of injury. Under-inflation increases sidewall flexing and rolling resistance, resulting in heat buildup and internal damage to the tire. It also may result in unnecessary tire stress, irregular wear, loss of vehicle control and accidents. A tire can lose up to half of its air pressure and not appear to be flat!

Always inflate your tires to the Ford recommended inflation pressure even if it is less than the maximum inflation pressure information found on the tire. The Ford recommended tire inflation pressure is found on the Safety Compliance Certification Label

(affixed to either the door hinge pillar, door-latch post, or the door edge that meets the door-latch post, next to the driver's seating position), or Tire Label which is located on the B-Pillar or the edge of the driver's door. Failure to follow the tire pressure recommendations can cause uneven treadwear patterns and adversely affect the way your vehicle handles.

Maximum Inflation Pressure is the tire manufacturer's maximum permissible pressure and the pressure at which the maximum load can be carried by the tire. This pressure is normally higher than the manufacturer's recommended cold inflation pressure which can be found on the Safety Compliance Certification Label (affixed to either the door hinge pillar, door-latch post, or the door edge that meets the door-latch post, next to the driver's seating position), or Tire Label which is located on the B-Pillar or the edge of the driver's door. The cold inflation pressure should never be set lower than the recommended pressure on the Safety Compliance Certification Label or Tire Label.

Wheels and Tires

When weather temperature changes occur, tire inflation pressures also change. A 43°F (6°C) temperature drop can cause a corresponding drop of 1 psi (7 kPa) in inflation pressure. Check your tire pressures frequently and adjust them to the proper pressure which can be found on the Safety Compliance Certification Label or Tire Label.

To check the pressure in your tire(s):

1. Make sure the tires are cool, meaning they are not hot from driving even a mile.

Note: *If you are checking tire pressure when the tire is hot, (for example, driven more than 1 mile [1.6 kilometers]), never bleed or reduce air pressure. The tires are hot from driving and it is normal for pressures to increase above recommended cold pressures. A hot tire at or below recommended cold inflation pressure could be significantly under-inflated.*

Note: *If you have to drive a distance to get air for your tire(s), check and record the tire pressure first and add the appropriate air pressure when you get to the pump. It is normal for tires to heat up and the air pressure inside to go up as you drive.*

2. Remove the cap from the valve on one tire, then firmly press the tire gauge onto the valve and measure the pressure.

3. Add enough air to reach the recommended air pressure.

Note: *If you overfill the tire, release air by pressing on the metal stem in the center of the valve. Then recheck the pressure with your tire gauge.*

4. Replace the valve cap.
5. Repeat this procedure for each tire, including the spare.

Note: *Some spare tires operate at a higher inflation pressure than the other tires. For T type mini-spare tires, see the Dissimilar spare wheel and tire assembly information for a description. Store and maintain at 60 psi (4.15 bar). For full-size and dissimilar spare tires, see the Dissimilar spare wheel and tire assembly information for a description. Store and maintain at the higher of the front and rear inflation pressure as shown on the Tire Label.*

6. Visually inspect the tires to make sure there are no nails or other objects embedded that could poke a hole in the tire and cause an air leak.
7. Check the sidewalls to make sure there are no gouges, cuts or bulges.

Wheels and Tires

Inspecting Your Tires and Wheel Valve Stems

Periodically inspect the tire treads for uneven or excessive wear and remove objects such as stones, nails or glass that may be wedged in the tread grooves. Check the tire and valve stems for holes, cracks, or cuts that may permit air leakage and repair or replace the tire and replace the valve stem. Inspect the tire sidewalls for cracking, cuts, bruises and other signs of damage or excessive wear. If internal damage to the tire is suspected, have the tire demounted and inspected in case it needs to be repaired or replaced. For your safety, tires that are damaged or show signs of excessive wear should not be used because they are more likely to blow out or fail.

Improper or inadequate vehicle maintenance can cause tires to wear abnormally. Inspect all your tires, including the spare, frequently, and replace them if one or more of the following conditions exist:

Tire Wear



E142546

When the tread is worn down to one sixteenth of an inch (2 mm), tires must be replaced to help prevent your vehicle from skidding and hydroplaning. Built-in treadwear indicators, or wear bars, which look like narrow strips of smooth rubber across the tread will appear on the tire when the tread is worn down to one sixteenth of an inch (2 mm).

When the tire tread wears down to the same height as these wear bars, the tire is worn out and must be replaced.

Damage

Periodically inspect the tire treads and sidewalls for damage (such as bulges in the tread or sidewalls, cracks in the tread groove and separation in the tread or sidewall). If damage is observed

Wheels and Tires

or suspected have the tire inspected by a tire professional. Tires can be damaged during off-road use, so inspection after off-road use is also recommended.

Age

WARNINGS

 Tires degrade over time depending on many factors such as weather, storage conditions, and conditions of use (load, speed, inflation pressure) the tires experience throughout their lives.

 In general, tires should be replaced after six years regardless of tread wear or even if they have not been used. However, heat caused by hot climates or frequent high-load conditions can accelerate the aging process and may require you to replace tires more frequently.

 You should replace your spare tire when you replace the road tires or after six years due to aging even if it has not been used.

U.S. DOT Tire Identification Number

Both United States and Canada Federal regulations require tire manufacturers to place standardized information on the sidewall of all tires. This information identifies and describes the fundamental characteristics of the tire and also provides a U.S. DOT Tire Identification Number for safety standard certification and in case of a recall.

This begins with the letters DOT and indicates that the tire meets all federal standards. The next two numbers or letters are the plant code designating where it was manufactured, the next two are the tire size code and the last four numbers represent the week and year the tire was built. For example, the numbers 317 mean the 31st week of 1997. After 2000 the numbers go to four digits. For example, 2501 means the 25th week of 2001. The numbers in between are identification codes used for traceability. This information is used to contact customers if a tire defect requires a recall.

Tire Replacement Requirements

Your vehicle is equipped with tires designed to provide a safe ride and handling capability.

Wheels and Tires







WARNINGS

 Only use replacement tires and wheels that are the same size, load index, speed rating and type (such as P-metric versus LT-metric or all-season versus all-terrain) as those originally provided by Ford. The recommended tire and wheel size may be found on either the Safety Compliance Certification Label (affixed to either the door hinge pillar, door-latch post, or the door edge that meets the door-latch post, next to the driver's seating position), or the Tire Label which is located on the B-Pillar or edge of the driver's door. If this information is not found on these labels, then you should contact your authorized dealer as soon as possible. Use of any tire or wheel not recommended by Ford can affect the safety and performance of your vehicle, which could result in an increased risk of loss of vehicle control, vehicle rollover, personal injury and death.

 To reduce the risk of serious injury, when mounting replacement tires and wheels, you should not exceed the maximum pressure indicated on the sidewall of the tire to set the beads without additional precautions listed below. If the beads do not seat at the maximum pressure indicated, re-lubricate and try again.

WARNINGS

 When inflating the tire for mounting pressures up to 20 psi (1.38 bar) greater than the maximum pressure on the tire sidewall, the following precautions must be taken to protect the person mounting the tire:

-  1. Make sure that you have the correct tire and wheel size.
 -  2. Lubricate the tire bead and wheel bead seat area again.
 -  3. Stand at a minimum of 12 ft (3.66 m) away from the wheel and tire assembly.
 -  4. Use both eye and ear protection.
-  For a mounting pressure more than 20 psi (1.38 bar) greater than the maximum pressure, a Ford dealer or other tire service professional should do the mounting.
-  Always inflate steel carcass tires with a remote air fill with the person inflating standing at a minimum of 12 ft (3.66 m) away from the wheel and tire assembly.

Important: Remember to replace the wheel valve stems when the road tires are replaced on your vehicle.

It is recommended that the two front tires or two rear tires generally be replaced as a pair.

Wheels and Tires

The tire pressure sensors mounted in the wheels (originally installed on your vehicle) are not designed to be used in aftermarket wheels.

The use of wheels or tires not recommended by Ford Motor Company may affect the operation of your tire pressure monitoring system.

If the tire pressure monitoring system indicator is flashing, your system is malfunctioning. Your replacement tire might be incompatible with your tire pressure monitoring system, or some component of the system may be damaged.

Safety Practices

WARNINGS



If your vehicle is stuck in snow, mud or sand, do not rapidly spin the tires; spinning the tires can tear the tire and cause an explosion. A tire can explode in as little as three to five seconds.



Do not spin the wheels at over 34 mph (55 km/h). The tires may fail and injure a passenger or bystander.

*Avoid potholes and objects on the road.

*Do not run over curbs or hit the tire against a curb when parking.

Highway Hazards

No matter how carefully you drive there's always the possibility that you may eventually have a flat tire on the highway. Drive slowly to the closest safe area out of traffic. This may further damage the flat tire, but your safety is more important.

If you feel a sudden vibration or ride disturbance while driving, or you suspect your tire or vehicle has been damaged, immediately reduce your speed. Drive with caution until you can safely pull off the road. Stop and inspect the tires for damage. If a tire is under-inflated or damaged, deflate it, remove wheel and replace it with your spare tire and wheel. If you cannot detect a cause, have the vehicle towed to the nearest repair facility or tire dealer to have the vehicle inspected.

Driving habits have a great deal to do with your tire mileage and safety.

*Observe posted speed limits.

*Avoid fast starts, stops and turns.

Wheels and Tires

Tire and Wheel Alignment

A bad jolt from hitting a curb or pothole can cause the front end of your vehicle to become misaligned or cause damage to your tires. If your vehicle seems to pull to one side when you're driving, the wheels may be out of alignment. Have an authorized dealer check the wheel alignment periodically.

Wheel misalignment in the front or the rear can cause uneven and rapid treadwear of your tires and should be corrected by an authorized dealer. Front-wheel drive vehicles and those with an independent rear suspension (if equipped) may require alignment of all four wheels.

The tires should also be balanced periodically. An unbalanced tire and wheel assembly may result in irregular tire wear.

Tire Rotation

Note: *If your tires show uneven wear ask an authorized dealer to check for and correct any wheel misalignment, tire imbalance or mechanical problem involved before tire rotation.*

Note: *Your vehicle may be equipped with a dissimilar spare wheel and tire assembly. A dissimilar spare wheel and tire assembly is defined as a spare wheel and tire assembly that is different in brand, size or appearance from the road tires and wheels. If you have a dissimilar spare wheel and tire assembly it is intended for temporary use only and should not be used in a tire rotation.*

Note: *After having your tires rotated, inflation pressure must be checked and adjusted to the vehicle requirements.*

Rotating your tires at the recommended interval (as indicated in the Scheduled Maintenance chapter) will help your tires wear more evenly, providing better tire performance and longer tire life. Sometimes irregular tire wear can be corrected by rotating the tires.

Rear-wheel drive vehicles (front tires on the left side of the diagram).

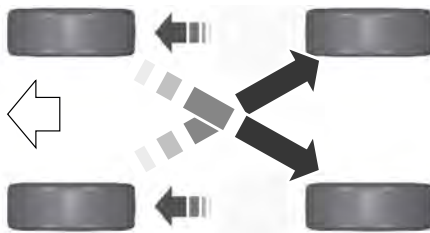

E142548

Wheels and Tires

Non-directional tires

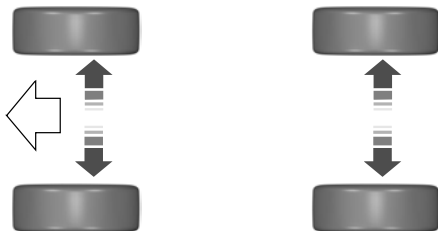

E209823

Vehicles equipped with different size tires on the front and rear axle

USING SUMMER TIRES

Summer tires provide superior performance on wet and dry roads. Summer tires do not have the Mud and Snow (M+S or M/S) tire traction rating on the tire side wall. Since summer tires do not have the same traction performance as All-season or Snow tires, we do not recommend using summer tires when temperatures drop to about 45°F (7°C) or below (depending on tire wear and environmental conditions) or in snow and ice conditions. Like any tire, summer tire performance is affected by tire wear and environmental conditions. If you must drive in those conditions, we recommend using Mud and Snow (M+S, M/S), All-season or Snow tires.

Always store your summer tires indoors at temperatures above 19°F (-7°C). The rubber compounds used in these tires lose flexibility and may develop surface cracks in the tread area at temperatures below 19°F (-7°C). If the tires have been subjected to 19°F (-7°C) or less, warm them in a heated space to at least 41°F (5°C) for at least 24 hours before installing

them on a vehicle, or moving the vehicle with the tires installed, or checking tire inflation. Do not place tires near heaters or heating devices used to warm the room where the tires are stored. Do not apply heat or blow heated air directly on the tires. Always inspect the tires after storage periods and before use.

USING SNOW CHAINS

WARNINGS



Driving too fast for conditions creates the possibility of loss of vehicle control. Driving at very high speeds for extended periods of time may result in damage to vehicle components.



Snow tires must be the same size, load index, speed rating as those originally provided by Ford. Use of any tire or wheel not recommended by Ford can affect the safety and performance of your vehicle, which could result in an increased risk of loss of vehicle control, vehicle rollover, personal injury and death. Additionally, the use of non-recommended tires and wheels could cause steering, suspension, axle, transfer case or power transfer unit failure.

The tires on your vehicle may have all-weather treads to provide traction in rain and snow. However, in some climates, you may need to use snow tires and chains. Use chains on the tires only in an emergency or if the law requires them.

Note: *The suspension insulation and bumpers will help prevent vehicle damage. Do not remove these components from your vehicle when using snow tires and chains.*

Follow these guidelines when using snow tires and chains:

Wheels and Tires

- If possible, avoid fully loading your vehicle.
- Chains may damage aluminum wheels.
- Use ultra low profile cables, 10 mm or less in dimension as measured on the sidewall of your tire, with 235/55R 17, 235/50R18 and 255/40R19 on the rear axle only.
- Do not use snow chains or cables with 275/40R19 and 265/35R20 tires.
- Not all S-class snow chains or cables meet these restrictions. Chains of this size restriction will include a tensioning device.
- Purchase chains or cables from a manufacturer that clearly labels body to tire dimension restrictions. The snow chains or cables must be mounted in pairs on the front or the rear tires only.
- Do not exceed 30 mph (50 km/h) if recommended by the chain manufacturer while using snow chains.
- Install cables securely, verifying that the cables do not touch any wiring, brake lines or fuel lines.
- Drive cautiously. If you hear the cables rub or bang against the vehicle, stop and retighten them. If this does not work, remove the cables to prevent vehicle damage.
- Remove the tire chains when they are no longer needed. Do not use tire chains on dry roads.

If you have any questions regarding snow chains or cables, please contact your authorized dealer.

TIRE PRESSURE MONITORING SYSTEM

WARNING



The tire pressure monitoring system is not a substitute for manually checking tire pressure. The tire pressure should be checked periodically (at least monthly) using a tire gauge, see Inflating your tires in this chapter. Failure to properly maintain your tire pressure could increase the risk of tire failure, loss of control, vehicle rollover and personal injury.



Each tire, including the spare (if provided), should be checked monthly when cold and inflated to the inflation pressure recommended by the vehicle manufacturer on the vehicle placard or tire inflation pressure label. (If your vehicle has tires of a different size than the size indicated on the vehicle placard or tire inflation pressure label, you should determine the proper tire inflation pressure for those tires.)

As an added safety feature, your vehicle has been equipped with a Tire Pressure Monitoring System (TPMS) that illuminates a low tire pressure telltale when one or more of your tires is significantly under-inflated. Accordingly, when the low tire pressure telltale illuminates, you should stop and check your tires as soon as possible, and inflate them to the proper pressure. Driving on a significantly under-inflated tire causes the tire to overheat and can lead to tire failure. Under-inflation also reduces fuel efficiency and tire tread life, and may affect the vehicle's handling and stopping ability.

Wheels and Tires

Please note that the TPMS is not a substitute for proper tire maintenance, and it is the driver's responsibility to maintain correct tire pressure, even if under-inflation has not reached the level to trigger illumination of the TPMS low tire pressure telltale.

Your vehicle has also been equipped with a TPMS malfunction indicator to indicate when the system is not operating properly. The TPMS malfunction indicator is combined with the low tire pressure telltale. When the system detects a malfunction, the telltale will flash for approximately one minute and then remain continuously illuminated. This sequence will continue upon subsequent vehicle start-ups as long as the malfunction exists.

When the malfunction indicator is illuminated, the system may not be able to detect or signal low tire pressure as intended. TPMS malfunctions may occur for a variety of reasons, including the installation of replacement or alternate tires or wheels on the vehicle that prevent the TPMS from functioning properly. Always check the TPMS malfunction telltale after replacing one or more tires or wheels on your vehicle to ensure that the replacement or alternate tires and wheels allow the TPMS to continue to function properly.

The tire pressure monitoring system complies with part 15 of the FCC rules and with RSS-210 of Industry Canada. Operation is subject to the following two conditions: (1) This device may not cause harmful interference, and (2) This device must accept any interference received, including interference that may cause undesired operation.

Changing Tires With a Tire Pressure Monitoring System



E142549

Note: Each road tire is equipped with a tire pressure sensor located inside the wheel and tire assembly cavity. The pressure sensor is attached to the valve stem. The pressure sensor is covered by the tire and is not visible unless the tire is removed. Take care when changing the tire to avoid damaging the sensor

You should always have your tires serviced by an authorized dealer.

Check the tire pressure periodically (at least monthly) using an accurate tire gauge. See *Inflating Your Tires* in this chapter.

Understanding Your Tire Pressure Monitoring System

The tire pressure monitoring system measures pressure in your four road tires and sends the tire pressure readings to your vehicle. See **General Information** (page 83). The low tire pressure warning light will turn on if the tire pressure is significantly low. Once the light is illuminated, your tires are under-inflated and need to be inflated to the manufacturer's recommended tire pressure. Even if the light turns on and a short time later turns off, your tire pressure still needs to be checked.

Wheels and Tires

When Your Temporary Spare Tire is Installed

When one of your road tires needs to be replaced with the temporary spare, the system will continue to identify an issue to remind you that the damaged road wheel and tire assembly needs to be repaired and put back on your vehicle.

To restore the full function of the tire pressure monitoring system, have the damaged road wheel and tire assembly repaired and remounted on your vehicle.

When You Believe Your System is Not Operating Properly

The main function of the tire pressure monitoring system is to warn you when your tires need air. It can also warn you in the event the system is no longer capable of functioning as intended. See the following chart for information concerning your tire pressure monitoring system:

Wheels and Tires

Low tire pressure warning light	Possible cause	Customer action required
Solid warning light	Tire(s) under-inflated	Make sure tires are at the proper pressure. See Inflating your tires in this chapter. After inflating your tires to the manufacturer's recommended pressure as shown on the Tire Label (located on the edge of driver's door or the B-Pillar), the vehicle must be driven for at least two minutes over 20 mph (32 km/h) before the light turns off.
	Spare tire in use	Repair the damaged road wheel and tire assembly and reinstall it on the vehicle to restore system function. For a description on how the system functions, see When your temporary spare tire is installed in this section.
	TPMS malfunction	If the tires are properly inflated and the spare tire is not in use but the light remains on, contact your authorized dealer as soon as possible.
Flashing warning light	Spare tire in use	Repair the damaged road wheel and tire assembly and reinstall it on the vehicle to restore system function. For a description on how the system functions, see When your temporary spare tire is installed in this section.
	TPMS malfunction	If the tires are properly inflated and the spare tire is not in use but the light remains on, contact your authorized dealer as soon as possible.

When Inflating Your Tires

When putting air into your tires (such as at a gas station or in your garage), the tire pressure monitoring system may not respond immediately to the air added to your tires.

It may take up to two minutes of driving over 20 mph (32 km/h) for the light to turn off after you have filled your tires to the recommended inflation pressure

Wheels and Tires

How Temperature Affects Your Tire Pressure

The tire pressure monitoring system monitors tire pressure in each pneumatic tire. While driving in a normal manner, a typical passenger tire inflation pressure may increase about 2 to 4 psi (14 to 28 kPa) from a cold start situation. If the vehicle is stationary overnight with the outside temperature significantly lower than the daytime temperature, the tire pressure may decrease about 3 psi (21 kPa) for a drop of 30°F (17°C) in ambient temperature. This lower pressure value may be detected by the tire pressure monitoring system as being significantly lower than the recommended inflation pressure and activate the system warning light for low tire pressure. If the low tire pressure warning light is on, visually check each tire to verify that no tire is flat. If one or more tires are flat, repair as necessary. Check the air pressure in the road tires. If any tire is under-inflated, carefully drive the vehicle to the nearest location where air can be added to the tires. Inflate all the tires to the recommended inflation pressure.

CHANGING A ROAD WHEEL

WARNINGS



The use of tire sealant may damage your tire pressure monitoring system and should only be used in roadside emergencies. If you must use a sealant, the Ford Tire Mobility Kit sealant should be used. The tire pressure monitoring system sensor and valve stem on the wheel must be replaced by an authorized dealer after use of the sealant.



See **Tire Pressure Monitoring System** (page 260). If the tire pressure monitor sensor becomes damaged, it will no longer function.

Note: *The tire pressure monitoring system indicator light will illuminate when the spare tire is in use. To restore the full function of the monitoring system, all road wheels equipped with tire pressure monitoring sensors must be mounted on the vehicle.*

If you get a flat tire while driving, do not apply the brake heavily. Instead, gradually decrease your speed. Hold the steering wheel firmly and slowly move to a safe place on the side of the road.

Have a flat serviced by an authorized dealer in order to prevent damage to the tire pressure monitoring system sensors. See **Tire Pressure Monitoring System** (page 260). Replace the spare tire with a road tire as soon as possible. During repairing or replacing of the flat tire, have the authorized dealer inspect the tire pressure monitoring system sensor for damage.

Dissimilar Spare Wheel and Tire Assembly Information

WARNING



Failure to follow these guidelines could result in an increased risk of loss of vehicle control, injury or death.

If you have a dissimilar spare wheel and tire, then it is intended for temporary use only. This means that if you need to use it, you should replace it as soon as possible with a road wheel and tire assembly that is the same size and type as the road tires and wheels that were originally provided by Ford. If the dissimilar spare tire or wheel is damaged, it should be replaced rather than repaired.

A dissimilar spare wheel and tire assembly is defined as a spare wheel and tire assembly that is different in brand, size or appearance from the road tires and wheels and can be one of three types:

Wheels and Tires

1. T-type mini-spare: This spare tire begins with the letter T for tire size and may have Temporary Use Only molded in the sidewall.

2. Full-size dissimilar spare with label on wheel: This spare tire has a label on the wheel that states: THIS WHEEL AND TIRE ASSEMBLY FOR TEMPORARY USE ONLY.

When driving with one of the dissimilar spare tires listed above, do not:

- Exceed 50 mph (80 km/h).
- Load the vehicle beyond maximum vehicle load rating listed on the Safety Compliance Label.
- Use snow chains on the end of the vehicle with the dissimilar spare tire.
- Use more than one dissimilar spare tire at a time.
- Use commercial car washing equipment.
- Try to repair the dissimilar spare tire.

Use of one of the dissimilar spare tires listed above at any one wheel location can lead to impairment of the following:

- Handling, stability and braking performance.
- Comfort and noise.
- Ground clearance and parking at curbs.
- Winter weather driving capability.
- Wet weather driving capability.
- All-wheel driving capability.

3. Full-size dissimilar spare without label on wheel

When driving with the full-size dissimilar spare wheel and tire assembly, do not:

- Exceed 70 mph (113 km/h).
- Use more than one dissimilar spare wheel and tire assembly at a time.

- Use commercial car washing equipment.
- Use snow chains on the end of the vehicle with the dissimilar spare wheel and tire assembly.

The usage of a full-size dissimilar spare wheel and tire assembly can lead to impairment of the following:

- Handling, stability and braking performance.
- Comfort and noise.
- Ground clearance and parking at curbs.
- Winter weather driving capability.
- Wet weather driving capability.
- All-wheel driving capability.

When driving with the full-size dissimilar spare wheel and tire assembly additional caution should be given to:

- Driving vehicles with a load on the cargo rack.

Drive cautiously when using a full-size dissimilar spare wheel and tire assembly and seek service as soon as possible.

Tire Change Procedure

WARNINGS







When one of the front wheels is off the ground, the transmission alone will not prevent your vehicle from moving or slipping off the jack, even if the transmission is in park (P) or reverse (R) for manual transmissions.



To help prevent your vehicle from moving when you change a tire, be sure to place the transmission in park (P) or reverse (R) for manual transmissions, set the parking brake and block (in both directions) the wheel that is diagonally opposite (other side and end of the vehicle) to the tire being changed.

Wheels and Tires

WARNINGS

-  Never get underneath a vehicle that is supported only by a jack. If your vehicle slips off the jack, you or someone else could be seriously injured.
-  Do not attempt to change a tire on the side of the vehicle close to moving traffic. Pull far enough off the road to avoid the danger of being hit when operating the jack or changing the wheel.
-  Always use the jack provided as original equipment with your vehicle. If using a jack other than the one provided as original equipment with your vehicle, make sure the jack capacity is adequate for the vehicle weight, including any vehicle cargo or modifications.
-  Check that the vehicle jack is not damaged or deformed and the thread is lubricated and clean.
-  Passengers should not remain in your vehicle when the vehicle is being jacked.

1. Park on a surface, set the parking brake and activate the hazard flashers.
2. Place the transmission in park (P) and turn the engine off. For vehicles with a manual transmission, place the transmission in reverse (R) after the engine is turned off.

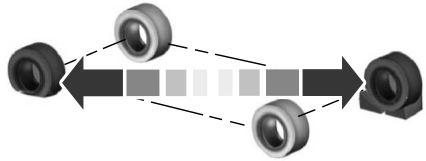

E175447

3. Block both the front and rear of the wheel diagonally opposite the flat tire. For example, if the left front tire is flat, block the right rear wheel.

Wheels and Tires

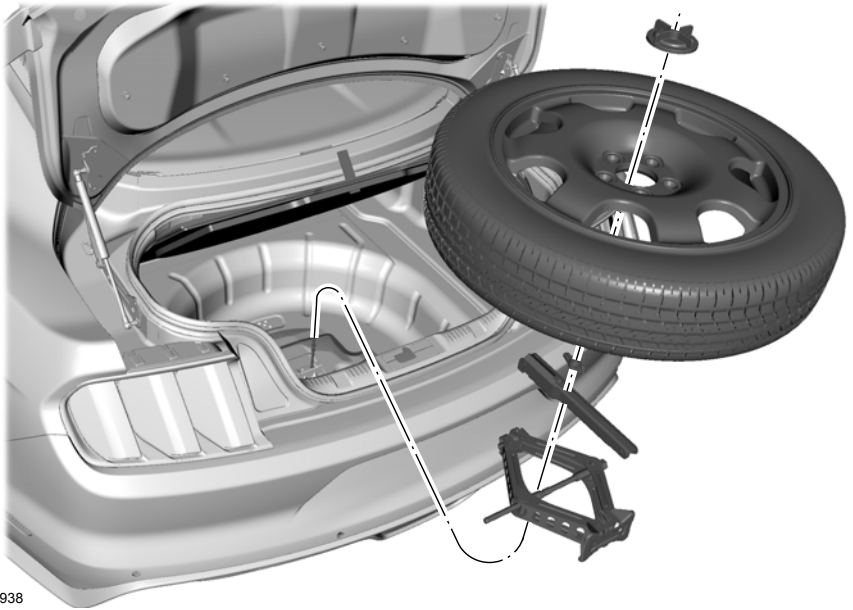

E174938

4. Remove the lug wrench, spare tire and jack.
5. Remove the center ornament from the wheel if required to access the lug nuts.
6. To remove the wrench from the jack, turn the hex nut on the jack counterclockwise. This will lower the jack and loosen the mechanical lock.
7. Loosen each wheel lug nut one-half turn counterclockwise but do not remove them until the wheel is raised off the ground.

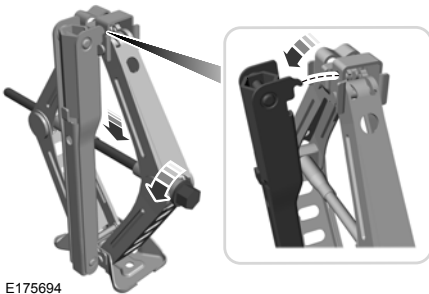

E175694

Wheels and Tires

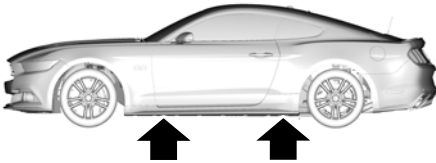

E176084

Note: Jack at the specified locations to avoid damage to the vehicle.

8. The vehicle jacking points are shown here, and can be identified by the triangle markings on the vehicle. Details are depicted on the warning label on the jack.



E174939

9. Place the jack at the jacking point next to the tire you are changing. Turn the jack handle clockwise until the wheel is completely off the ground.
10. Remove the lug nuts with the lug wrench.

11. Replace the flat tire with the spare tire, making sure the valve stem is facing outward. Reinstall lug nuts until the wheel is snug against the hub. Do not fully tighten the lug nuts until the wheel has been lowered. If you are using the temporary tire, the lug nut washers will not appear to be flush with the rim. This is normal only when using the temporary spare tire.
12. Lower the wheel by turning the jack handle counterclockwise.

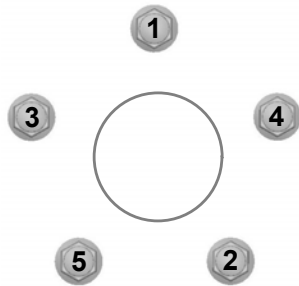

E75442

13. Remove the jack and fully tighten the lug nuts in the order shown. See **Technical Specifications** (page 270).
14. To store the folded wrench on the jack, engage the bracket of the jack base on the wrench feature as shown. Swing the wrench upwards and adjust the height of the jack until the pin engages the hole. Tighten the hex nut clockwise by hand until secure.

Wheels and Tires



E176165

15. Put the flat tire, wheel ornament, jack and lug wrench away. Make sure the jack is fastened so it does not rattle when you drive.
16. Unblock the wheel.

DRIVING AT HIGH SPEED

Tire pressure - Speeds greater than 100 mph (160 km/h)

WARNING



To reduce the risk of potential tire failure that could lead to serious injury or death, increase the front and rear tire placard pressures by the amount shown on the warning label, located on either the driver side B-pillar or door, when driving over 100 mph (160 km/h). Only travel at speeds over 100 mph (160 km/h) where it is legal and conditions allow. The tire placard pressure can be found on the tire placard located on either the driver side B-pillar or door of your vehicle.



Warning: Failure to follow these instructions can result in a loss of vehicle stability due to tire failure that could lead to serious injury or death. If you are not sure about the proper tire inflation pressures, contact an authorized dealer or service center.

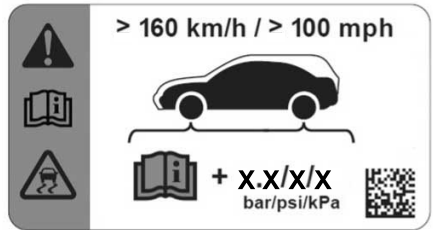

E184089

Your tires may require additional inflation pressure for operation at speeds greater than 100 mph (160 km/h). If this label is present on your vehicle, you must adjust the tire pressure accordingly.

Wheels and Tires

TECHNICAL SPECIFICATIONS

Wheel Lug Nut Torque Specifications

WARNING

 When a wheel is installed, always remove any corrosion, dirt or foreign materials present on the mounting surfaces of the wheel or the surface of the wheel hub, brake drum or brake disc that contacts the wheel. Make sure that any fasteners that attach the rotor to the hub are secured so they do not interfere with the mounting surfaces of the wheel. Installing wheels without correct metal-to-metal contact at the wheel mounting surfaces can cause the wheel nuts to loosen and the wheel to come off while your vehicle is in motion, resulting in a loss of control.

Bolt size	lb-ft (Nm)*
M14 X 1.5	150 lb.ft (204 Nm)

*Torque specifications are for nut and bolt threads free of dirt and rust. Use only Ford recommended replacement fasteners.

Retighten the lug nuts to the specified torque within 100 miles (160 kilometers) after any wheel disturbance (such as tire rotation, changing a flat tire, wheel removal).



E145950

A Wheel pilot bore

Inspect the wheel pilot bore and mounting surface prior to installation. Remove any visible corrosion or loose particles.

Capacities and Specifications

ENGINE SPECIFICATIONS - 2.3L ECOBOOST™

Engine	2.3L EcoBoost
Cubic inches	138
Firing order	1-3-4-2
Ignition system	Coil on plug
Spark plug gap	0.028 in (0.7 mm) - 0.031 in (0.8 mm)
Compression ratio	9.5:1

Drivebelt Routing

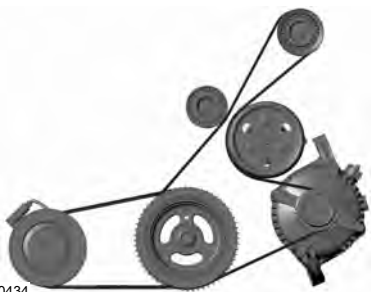

E170434

ENGINE SPECIFICATIONS - 3.7L

Engine	3.7L
Cubic inches	226
Firing order	1-4-2-5-3-6
Ignition system	Coil on plug
Spark plug gap	0.049 in (1.25 mm) - 0.053 in (1.35 mm)
Compression ratio	10.5:1

Capacities and Specifications

Drivebelt Routing

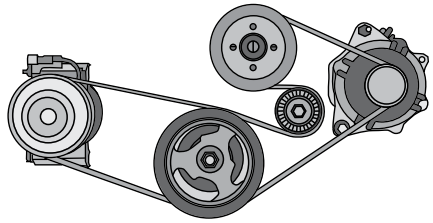

E167464

ENGINE SPECIFICATIONS - 5.0L

Engine	5.0L
Cubic inches	302
Firing order	1-5-4-8-6-3-7-2
Ignition system	Coil on plug
Spark plug gap	0.049 in (1.25 mm) - 0.053 in (1.35 mm)
Compression ratio	11.0:1

Drivebelt Routing

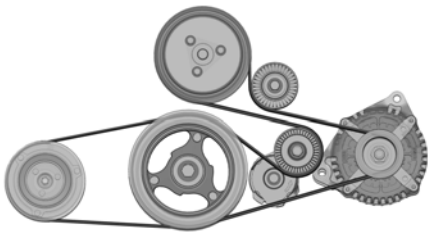

E198573

Capacities and Specifications

MOTORCRAFT PARTS - 2.3L ECOBOOST™

Component	Part Number
Air filter element.	FA-1918
Oil filter.	FL-910-S
Battery.	BXT-96R-590
Spark plugs.	SP-537
Transmission filter	FT-188
Cabin air filter.	FP-78
Windshield wiper blade.	WW-1964 (passenger side) WW-2160 (driver side)

We recommend Motorcraft replacement parts available at your Ford dealer or at fordparts.com for scheduled maintenance. These parts meet or exceed Ford Motor Company's specifications and are engineered for your vehicle. Use of other parts may impact vehicle performance, emissions and durability. Your warranty may be void for any damage related to use of other parts.

If a Motorcraft oil filter is not available, use an oil filter that meets industry performance specification SAE/USCAR-36.

For spark plug replacement, contact an authorized dealer. Replace the spark plugs at the appropriate intervals. See **Scheduled Maintenance** (page 422).

Capacities and Specifications

MOTORCRAFT PARTS - 3.7L

Component	Part Number
Air filter element.	FA-1918
Oil filter.	FL-500-S
Battery.	BXT-96R-590
Spark plugs.	SP-520
Transmission filter	FT-188
Cabin air filter.	FP-78
Windshield wiper blade.	WW-1964 (passenger side) WW-2160 (driver side)

We recommend Motorcraft replacement parts available at your Ford dealer or at fordparts.com for scheduled maintenance. These parts meet or exceed Ford Motor Company's specifications and are engineered for your vehicle. Use of other parts may impact vehicle performance, emissions and durability. Your warranty may be void for any damage related to use of other parts.

If a Motorcraft oil filter is not available, use an oil filter that meets industry performance specification SAE/USCAR-36.

For spark plug replacement, contact an authorized dealer. Replace the spark plugs at the appropriate intervals. See **Scheduled Maintenance** (page 422).

Capacities and Specifications

MOTORCRAFT PARTS - 5.0L

Component	Part Number
Air filter element.	FA-1918
Oil filter.	FL-500-S
Battery.	BXT-96R-590
Spark plugs.	SP-548
Transmission filter.	FT-188
Cabin air filter.	FP-78
Windshield wiper blade.	WW-1964 (passenger side) WW-2160 (driver side)

We recommend Motorcraft replacement parts available at your Ford dealer or at fordparts.com for scheduled maintenance. These parts meet or exceed Ford Motor Company's specifications and are engineered for your vehicle. Use of other parts may impact vehicle performance, emissions and durability. Your warranty may be void for any damage related to use of other parts.

If a Motorcraft oil filter is not available, use an oil filter that meets industry performance specification SAE/USCAR-36.

For spark plug replacement, contact an authorized dealer. Replace the spark plugs at the appropriate intervals. See **Scheduled Maintenance** (page 422).

Capacities and Specifications

VEHICLE IDENTIFICATION NUMBER

The vehicle identification number is located on the left-hand side of the instrument panel.

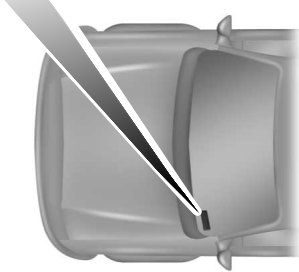

E142476

Please note that in the graphic, XXXX is representative of your vehicle identification number.

The Vehicle Identification Number contains the following information:

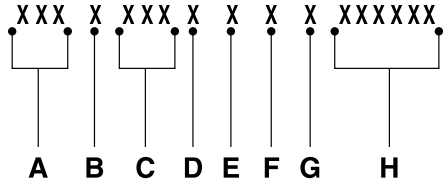

E142477

- A World manufacturer identifier
- B Brake system, Gross Vehicle Weight Rating, Restraint Devices and their locations
- C Make, vehicle line, series, body type
- D Engine type
- E Check digit
- F Model year
- G Assembly plant
- H Production sequence number

Capacities and Specifications

VEHICLE CERTIFICATION LABEL

MFD. BY FORD MOTOR CO.

DATE: XX/XX GVWR: XXXX KG (XXXX LB)
 FRONT GAWR: REAR GAWR:
 XXXX KG (XXXX LB) WITH XXXX KG (XXXX LB) WITH
 TIRES TIRES
 XXXXXXXXXXXXXXXX TIRES XXXXXXXXXXXXXXXX TIRES
 XXXXXXXX RIMS XXXXXXXX RIMS
 AT XXXX kPa/ XXX PSI COLD AT XXXX kPa/ XXX PSI COLD

THIS VEHICLE CONFORMS TO ALL APPLICABLE FEDERAL MOTOR VEHICLE SAFETY AND THEFT PREVENTION STANDARDS IN EFFECT ON THE DATE OF MANUFACTURE SHOWN ABOVE.

VIN: XXXXXXXXXXXXXXXXXXXX XXXXX
 TYPE: XXXX XXXXX



EXT PNT: XX XXXXXX RC: XX DSO: XXXX
 WB INT TR TP/PS R AXLE TR SPR XXXX
 XXX XX XXX X XX X XXXX XXXX
 XXXXXXXXXXXXXXX XXX XXXX-XXXXXXXX-XX

E167469

The National Highway Traffic Safety Administration Regulations require that a Safety Compliance Certification Label be affixed to a vehicle and prescribe where the Safety Compliance Certification Label may be located. The Safety Compliance Certification Label shall be affixed to either the door hinge pillar, the door latch post, or the edge of the door near the door latch, next to the driver's seating position.

TRANSMISSION CODE DESIGNATION

MFD. BY FORD MOTOR CO.

DATE: XX/XX GVWR: XXXX KG (XXXX LB)
 FRONT GAWR: REAR GAWR:
 XXXX KG (XXXX LB) WITH XXXX KG (XXXX LB) WITH
 TIRES TIRES
 XXXXXXXXXXXXXXXX TIRES XXXXXXXXXXXXXXXX TIRES
 XXXXXXXX RIMS XXXXXXXX RIMS
 AT XXXX kPa/ XXX PSI COLD AT XXXX kPa/ XXX PSI COLD

THIS VEHICLE CONFORMS TO ALL APPLICABLE FEDERAL MOTOR VEHICLE SAFETY AND THEFT PREVENTION STANDARDS IN EFFECT ON THE DATE OF MANUFACTURE SHOWN ABOVE.

VIN: XXXXXXXXXXXXXXXXXXXX XXXXX
 TYPE: XXXX XXXXX



EXT PNT: XX XXXXXX RC: XX DSO: XXXX
 WB INT TR TP/PS R AXLE TR SPR XXXX
 XXX XX XXX X XX X XXXX XXXX
 XXXXXXXXXXXXXXX XXX XXXX-XXXXXXXX-XX

↑

E167814

The transmission code is on the Safety Compliance Certification Label. The following table shows the transmission code along with the transmission description.

Description	Code
Six-speed automatic transmission 6R80E	3
Six-speed manual transmission MT82	X

Capacities and Specifications

CAPACITIES AND SPECIFICATIONS - 2.3L ECOBOOST™

Capacities

WARNING



The air conditioning refrigerant system contains refrigerant under high pressure. Only qualified personnel should service the air conditioning refrigerant system. Opening the air conditioning refrigerant system can cause personal injury.

Item	Capacity
Engine oil (with oil filter).	5.7 qt (5.4 L)
Engine coolant.	9.5 qt (8.96 L)
Brake fluid.	Between MIN/MAX on brake fluid reservoir
Rear axle fluid.	3.2 pt (1.5L)
Rear axle friction modifier.	3.28 fl oz (97 ml)
Automatic transmission fluid.	11.6 qt (10.98 L) *
Manual transmission fluid.	2.7 qt (2.6 L) *
Windshield washer fluid.	Fill as required
Fuel tank.	15.5 gal (58.8 L)
A/C Refrigerant.	21 oz (0.6 kg)
A/C Refrigerant Compressor Oil.	3.4 fl oz (100.5 ml)

*Approximate dry fill capacity. Actual amount may vary during fluid changes.

Capacities and Specifications

Specifications

Materials

Name	Specification
Recommended motor oil (U.S.): Motorcraft® SAE 5W-30 Premium Synthetic Blend Motor Oil XO-5W30-QSP	WSS-M2C946-A
Recommended motor oil (Canada): Motorcraft® SAE 5W-30 Super Premium Motor Oil CXO-5W30-LSP12	WSS-M2C946-A
Recommended motor oil (Mexico): Motorcraft® SAE 5W-30 Premium Synthetic Blend Motor Oil MXO-5W30-QSP	WSS-M2C946-A
Optional motor oil (U.S. and Mexico): Motorcraft® SAE 5W-30 Full Synthetic Motor Oil XO-5W30-QFS	WSS-M2C946-A
Optional motor oil (Canada): Motorcraft® SAE 5W-30 Synthetic Motor Oil CXO-5W30-LFS12	WSS-M2C946-A
Engine coolant (U.S. and Mexico): Motorcraft® Orange Prediluted Antifreeze/Coolant VC-3DIL-B	WSS-M97B44-D2
Engine coolant (Canada): Motorcraft® Orange Prediluted Antifreeze/Coolant CVC-3DIL-B	WSS-M97B44-D2
Brake fluid: Motorcraft® DOT 4 Low Viscosity (LV) High Performance Motor Vehicle Brake Fluid PM-20	WSS-M6C65-A2
Rear axle fluid: Motorcraft® SAE 75W-85 Premium Synthetic Hypoid Gear Lubricant XY-75W85-QL	WSS-M2C942-A
Rear axle friction modifier (U.S. and Mexico): Motorcraft® Additive Friction Modifier XL-3	EST-M2C118-A*
Rear axle friction modifier (Canada):	EST-M2C118-A*

Capacities and Specifications

Name	Specification
Motorcraft® Additive Friction Modifier CXL-3	
Automatic transmission fluid (U.S. and Mexico): Motorcraft® MERCON LV Automatic Transmission Fluid XT-10-QLVC	WSS-M2C938-A MERCON LV
Automatic transmission fluid (Canada): Motorcraft® MERCON LV Automatic Transmission Fluid CXT-10-LV12	WSS-M2C938-A MERCON LV
Manual transmission fluid : Motorcraft® Dual Clutch Transmission Fluid XT-11-QDC	WSS-M2C200-D2
Windshield washer fluid (U.S. and Mexico): Motorcraft® Premium Windshield Wash Concentrate with Bitterant ZC-32-B2	WSS-M14P19-A
Windshield washer fluid (Canada): Motorcraft® Premium Quality Windshield Washer Fluid CXC-37-(A, B, D, F)	WSS-M14P19-A
A/C refrigerant (U.S.): Motorcraft® R-134a Refrigerant YN-19	WSH-M17B19-A
A/C refrigerant (Canada): Motorcraft® R-134a Refrigerant CYN-16-R	WSH-M17B19-A
A/C refrigerant (Mexico): Motorcraft® R-134a Refrigerant MYN-19	WSH-M17B19-A
A/C refrigerant compressor oil: Motorcraft® PAG Refrigerant Compressor Oil YN-12-D	WSH-M1C231-B
Multi-purpose grease: Motorcraft® Multi-Purpose Grease Spray XL-5-A	ESB-M1C93-B
Lock cylinders (U.S.): Penetrating and Lock Lubricant XL-1	--

Capacities and Specifications

Name	Specification
Lock cylinders (Canada): Penetrating Fluid CXC-51-A	--
Lock cylinders (Mexico): Penetrating and Lock Lubricant MXL-1	--

*For complete refill of limited slip Ford axles, add 3.28 fl oz (97 ml) of Additive Friction Modifier XL-3 or equivalent meeting Ford Specification EST-M2C118-A. Ford rear axles contain a synthetic lubricant that does not require changing unless you submerge the axle in water.

If you use oil and fluids that do not meet the defined specification and viscosity grade, this may lead to:

- Component damage which is not covered by the vehicle warranty.
- Longer engine cranking periods.
- Increased emission levels.
- Reduced engine performance.
- Reduced fuel economy.
- Degraded brake performance.

We recommend Motorcraft® motor oil for your vehicle. If Motorcraft® oil is not available, use motor oils of the recommended viscosity grade that meet API SN requirements and display the API Certification Mark for gasoline engines. Do not use oil labeled with API SN service category unless the label also displays the API certification mark.



E142732

An oil with this trademark symbol conforms to current engine, emission system protection standards and fuel economy requirements of the International Lubricant Standardization and Approval Committee (ILSAC), comprised of U.S. and Japanese automobile manufacturers.

Do not use supplemental engine oil additives because they are unnecessary and could lead to engine damage that may not be covered by your vehicle warranty.

Capacities and Specifications

Note: Ford recommends using DOT 4 Low Viscosity (LV) High Performance Brake Fluid or equivalent meeting WSS-M6C65-A2. Use of any fluid other than the recommended fluid may cause degraded brake performance and not meet the Ford performance standards. Keep brake fluid clean and dry. Contamination with dirt, water, petroleum products or other materials may result in brake system damage and possible failure.

Note: Automatic transmissions that require MERCON LV transmission fluid should only use MERCON LV transmission fluid. The use of any other fluid may cause transmission damage.

Alternative Engine Oil for Extremely Cold Climates

To improve engine cold start performance, we recommend that you use the following alternative engine oil in extremely cold climates, where the ambient temperature reaches -22.0°F (-30°C) or below.

Name	Specification
Motorcraft® SAE 0W-30 Premium Synthetic Blend Motor Oil: Engine oil - SAE 0W-30 XO-0W30-QSP	WSS-M2C953-A1

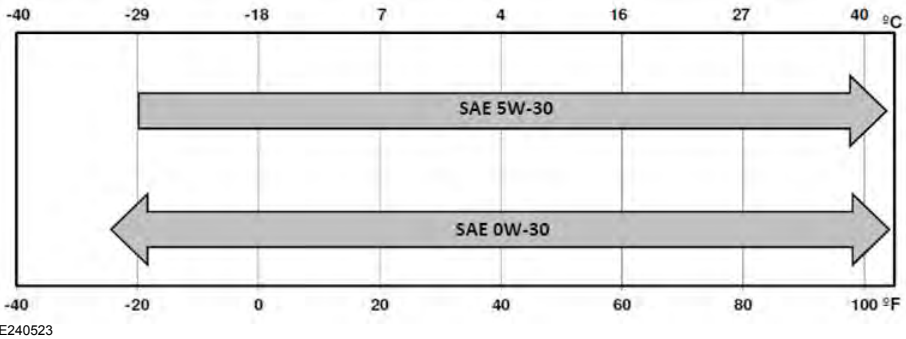

We recommend Motorcraft® motor oil for your vehicle. If Motorcraft® oil is not available, use motor oils of the recommended viscosity grade that meet API SN requirements and display the API Certification Mark for gasoline engines. Do not use oil labeled with API SN service category unless the label also displays the API certification mark.

Capacities and Specifications

CAPACITIES AND SPECIFICATIONS - 3.7L

Capacities

WARNING



The air conditioning refrigerant system contains refrigerant under high pressure. Only qualified personnel should service the air conditioning refrigerant system. Opening the air conditioning refrigerant system can cause personal injury.

Item	Capacity
Engine oil (with oil filter).	6.0 qt (5.7 L)
Engine coolant.	12.4 qt (11.7 L)
Brake fluid.	Between MIN/MAX on brake fluid reservoir
Rear axle fluid.	3.2 pt (1.5L)
Rear axle friction modifier.	3.28 fl oz (97 ml)
Automatic transmission fluid.	12.0 qt (11.4 L) *
Manual transmission fluid.	2.7 qt (2.6 L) *
Windshield washer fluid.	Fill as required
Fuel tank.	16.0 gal (60.6 L)
A/C refrigerant.	21 oz (0.6 kg)
A/C refrigerant compressor oil.	3.4 fl oz (100.5 ml)

*Approximate dry fill capacity. Actual amount may vary during fluid changes.

Capacities and Specifications

Specifications

Materials

Name	Specification
Recommended motor oil (U.S.): Motorcraft® SAE 5W-20 Premium Synthetic Blend Motor Oil XO-5W20-QSP	WSS-M2C945-A
Recommended motor oil (Canada): Motorcraft® SAE 5W-20 Super Premium Motor Oil CXO-5W20-LSP12	WSS-M2C945-A
Recommended motor oil (Mexico): Motorcraft® SAE 5W-20 Premium Synthetic Blend Motor Oil MXO-5W20-QSP	WSS-M2C945-A
Optional motor oil (U.S. and Mexico): Motorcraft® SAE 5W-20 Full Synthetic Motor Oil XO-5W20-QFS	WSS-M2C945-A
Optional motor oil (Canada): Motorcraft® SAE 5W-20 Synthetic Motor Oil CXO-5W20-LFS12	WSS-M2C945-A
Engine coolant (U.S. and Mexico): Motorcraft® Orange Prediluted Antifreeze/Coolant VC-3DIL-B	WSS-M97B44-D2
Engine coolant (Canada): Motorcraft® Orange Prediluted Antifreeze/Coolant CVC-3DIL-B	WSS-M97B44-D2
Brake fluid: Motorcraft® DOT 4 Low Viscosity (LV) High Performance Motor Vehicle Brake Fluid PM-20	WSS-M6C65-A2
Rear axle fluid: Motorcraft® SAE 75W-85 Premium Synthetic Hypoid Gear Lubricant XY-75W85-QL	WSS-M2C942-A
Rear axle friction modifier (U.S. and Mexico): Motorcraft® Additive Friction Modifier XL-3	EST-M2C118-A*
Rear axle friction modifier (Canada):	EST-M2C118-A*

Capacities and Specifications

Name	Specification
Motorcraft® Additive Friction Modifier CXL-3	
Automatic transmission fluid (U.S. and Mexico): Motorcraft® MERCON LV Automatic Transmission Fluid XT-10-QLVC	WSS-M2C938-A MERCON LV
Automatic transmission fluid (Canada): Motorcraft® MERCON LV Automatic Transmission Fluid CXT-10-LV12	WSS-M2C938-A MERCON LV
Manual transmission fluid : Motorcraft® Dual Clutch Transmission Fluid XT-11-QDC	WSS-M2C200-D2
Windshield washer fluid (U.S. and Mexico): Motorcraft® Premium Windshield Wash Concentrate with Bitterant ZC-32-B2	WSS-M14P19-A
Windshield washer fluid (Canada): Motorcraft® Premium Quality Windshield Washer Fluid CXC-37-(A, B, D, F)	WSS-M14P19-A
A/C refrigerant (U.S.): Motorcraft® R-134a Refrigerant YN-19	WSH-M17B19-A
A/C refrigerant (Canada): Motorcraft® R-134a Refrigerant CYN-16-R	WSH-M17B19-A
A/C refrigerant (Mexico): Motorcraft® R-134a Refrigerant MYN-19	WSH-M17B19-A
A/C refrigerant compressor oil: Motorcraft® PAG Refrigerant Compressor Oil YN-12-D	WSH-M1C231-B
Multi-purpose grease: Motorcraft® Multi-Purpose Grease Spray XL-5-A	ESB-MIC93-B
Lock cylinders (U.S.): Penetrating and Lock Lubricant XL-1	--

Capacities and Specifications

Name	Specification
Lock cylinders (Canada): Penetrating Fluid CXC-51-A	--
Lock cylinders (Mexico): Penetrating and Lock Lubricant MXL-1	--

*For complete refill of limited slip Ford axles, add 3.28 fl oz (97 ml) of Additive Friction Modifier XL-3 or equivalent meeting Ford Specification EST-M2C118-A. Ford rear axles contain a synthetic lubricant that does not require changing unless you submerge the axle in water.

If you use oil and fluids that do not meet the defined specification and viscosity grade, this may lead to:

- Component damage, which the vehicle warranty does not cover.
- Longer engine cranking periods.
- Increased emission levels.
- Reduced engine performance.
- Reduced fuel economy.
- Degraded brake performance.

Only use fluid that meets Ford specifications.

We recommend Motorcraft® motor oil for your vehicle. If Motorcraft® oil is not available, use motor oils of the recommended viscosity grade that meet API SN requirements and display the API Certification Mark for gasoline engines. Do not use oil labeled with API SN service category unless the label also displays the API certification mark.



E142732

An oil with this trademark symbol conforms to current engine, emission system protection standards and fuel economy requirements of the International Lubricant Standardization and Approval Committee (ILSAC), comprised of U.S. and Japanese automobile manufacturers.

Do not use supplemental engine oil additives because they are unnecessary and could lead to engine damage that may not be covered by your vehicle warranty.

Capacities and Specifications

Note: Ford recommends using DOT 4 Low Viscosity (LV) High Performance Brake Fluid or equivalent meeting WSS-M6C65-A2. Use of any fluid other than the recommended fluid may cause degraded brake performance and not meet the Ford performance standards. Keep brake fluid clean and dry. Contamination with dirt, water, petroleum products or other materials may result in brake system damage and possible failure.

Note: Automatic transmissions that require MERCON LV transmission fluid should only use MERCON LV transmission fluid. The use of any other fluid may cause transmission damage.

Alternative Engine Oil for Extremely Cold Climates

To improve engine cold start performance, we recommend that you use the following alternative engine oil in extremely cold climates, where the ambient temperature reaches -22.0°F (-30°C) or below.

Name	Specification
Motorcraft® SAE 0W-20 Premium Synthetic Blend Motor Oil: Engine oil - SAE 0W-20 XO-0W20-QSP	WSS-M2C947-A

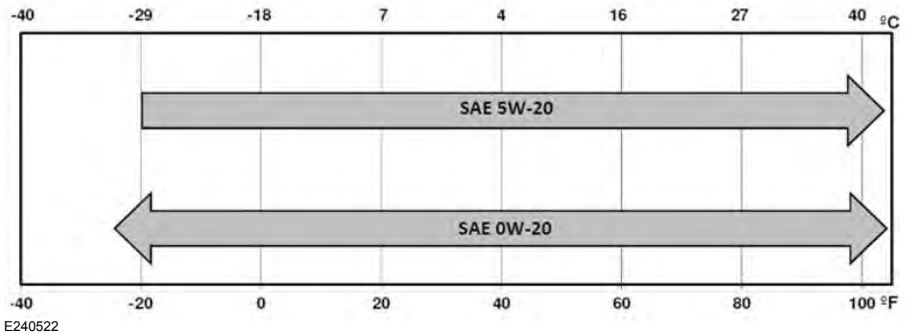

We recommend Motorcraft® motor oil for your vehicle. If Motorcraft® oil is not available, use motor oils of the recommended viscosity grade that meet API SN requirements and display the API Certification Mark for gasoline engines. Do not use oil labeled with API SN service category unless the label also displays the API certification mark.

Capacities and Specifications

CAPACITIES AND SPECIFICATIONS - 5.0L

Capacities

WARNING



The air conditioning refrigerant system contains refrigerant under high pressure. Only qualified personnel should service the air conditioning refrigerant system. Opening the air conditioning refrigerant system can cause personal injury.

Item	Capacity
Engine oil (with oil filter).	8.0 qt (7.6 L)
Engine coolant.	13.6 qt (12.88 L)
Engine coolant with Track Pack (If equipped).	15.2 qt (14.4 L)
Brake fluid.	Between MIN/MAX on brake fluid reservoir
Rear axle fluid.	3.2 pt (1.5L)
Rear axle friction modifier.	3.28 fl oz (97 ml)
Automatic transmission fluid.	11.8 qt (11.17 L) *
Manual transmission fluid.	2.7 qt (2.6 L) *
Windshield washer fluid.	Fill as required
Fuel tank.	16.0 gal (60.6 L)
A/C Refrigerant.	24.0 oz (0.68 kg)
A/C Refrigerant Compressor Oil.	4.1 fl oz (120 ml)

*Approximate dry fill capacity. Actual amount may vary during fluid changes.

Capacities and Specifications

Specifications

Materials

Name	Specification
Recommended motor oil (U.S.): Motorcraft® SAE 5W-20 Premium Synthetic Blend Motor Oil XO-5W20-QSP	WSS-M2C945-A
Recommended motor oil (Canada): Motorcraft® SAE 5W-20 Premium Synthetic Blend Motor Oil CXO-5W20-LSP12	WSS-M2C945-A
Recommended motor oil (Mexico): Motorcraft® SAE 5W-20 Premium Synthetic Blend Motor Oil MXO-5W20-QSP	WSS-M2C945-A
Optional motor oil (U.S. and Mexico): Motorcraft® SAE 5W-20 Full Synthetic Motor Oil XO-5W20-QFS	WSS-M2C945-A
Optional motor oil (Canada): Motorcraft® SAE 5W-20 Synthetic Motor Oil CXO-5W20-LFS12	WSS-M2C945-A
Engine coolant (U.S. and Mexico): Motorcraft® Orange Prediluted Antifreeze/Coolant VC-3DIL-B	WSS-M97B44-D2
Engine coolant (Canada): Motorcraft® Orange Prediluted Antifreeze/Coolant CVC-3DIL-B	WSS-M97B44-D2
Brake fluid: Motorcraft® DOT 4 Low Viscosity (LV) High Performance Motor Vehicle Brake Fluid PM-20	WSS-M6C65-A2
Rear axle fluid: Motorcraft® SAE 75W-85 Premium Synthetic Hypoid Gear Lubricant XY-75W85-QL	WSS-M2C942-A
Rear axle friction modifier (U.S. and Mexico): Motorcraft® Additive Friction Modifier XL-3	EST-M2C118-A*

Capacities and Specifications

Name	Specification
Rear axle friction modifier (Canada): Motorcraft® Additive Friction Modifier CXL-3	EST-M2C118-A*
Automatic transmission fluid (U.S. and Mexico): Motorcraft® MERCON LV Automatic Transmission Fluid XT-10-QLVC	WSS-M2C938-A MERCON LV
Automatic transmission fluid (Canada): Motorcraft® MERCON LV Automatic Transmission Fluid CXT-10-LV12	WSS-M2C938-A MERCON LV
Manual transmission fluid: Motorcraft® Dual Clutch Transmission Fluid XT-11-QDC	WSS-M2C200-D2
Windshield washer fluid (U.S. and Mexico): Motorcraft® Premium Windshield Wash Concentrate with Bitterant ZC-32-B2	WSS-M14P19-A
Windshield washer fluid (Canada): Motorcraft® Premium Quality Windshield Washer Fluid CXC-37-(A, B, D, F)	WSS-M14P19-A
A/C refrigerant (U.S.): Motorcraft® R-134a Refrigerant YN-19	WSH-M17B19-A
A/C refrigerant (Canada): Motorcraft® R-134a Refrigerant CYN-16-R	WSH-M17B19-A
A/C refrigerant (Mexico): Motorcraft® R-134a Refrigerant MYN-19	WSH-M17B19-A
A/C refrigerant compressor oil: Motorcraft® PAG Refrigerant Compressor Oil YN-12-D	WSH-M1C231-B
Multi-purpose grease: Motorcraft® Multi-Purpose Grease Spray XL-5-A	ESB-M1C93-B
Lock cylinders (U.S.): Penetrating and Lock Lubricant XL-1	--

Capacities and Specifications

Name	Specification
Lock cylinders (Canada): Penetrating Fluid CXC-51-A	--
Lock cylinders (Mexico): Penetrating and Lock Lubricant MXL-1	--

*For complete refill of limited slip Ford axles, add 3.28 fl oz (97 ml) of Additive Friction Modifier XL-3 or equivalent meeting Ford Specification EST-M2C118-A. Ford rear axles contain a synthetic lubricant that does not require changing unless you submerge the axle in water.

If you use oil and fluids that do not meet the defined specification and viscosity grade, this may lead to:

- Component damage which is not covered by the vehicle warranty.
- Longer engine cranking periods.
- Increased emission levels.
- Reduced engine performance.
- Reduced fuel economy.
- Degraded brake performance.

Only use fluid that meets Ford specifications.

We recommend Motorcraft® motor oil for your vehicle. If Motorcraft® oil is not available, use motor oils of the recommended viscosity grade that meet API SN requirements and display the API Certification Mark for gasoline engines. Do not use oil labeled with API SN service category unless the label also displays the API certification mark.



E142732

An oil with this trademark symbol conforms to current engine, emission system protection standards and fuel economy requirements of the International Lubricant Standardization and Approval Committee (ILSAC), comprised of U.S. and Japanese automobile manufacturers.

Do not use supplemental engine oil additives because they are unnecessary and could lead to engine damage that may not be covered by your vehicle warranty.

Capacities and Specifications

Note: Ford recommends using DOT 4 LV High Performance Brake Fluid or equivalent meeting WSS-M6C65-A2. Use of any fluid other than the recommended fluid may cause degraded brake performance and not meet the Ford performance standards. Keep brake fluid clean and dry. Contamination with dirt, water, petroleum products or other materials may result in brake system damage and possible failure.

Note: Automatic transmissions that require MERCON® LV transmission fluid should only use MERCON® LV transmission fluid. The use of any other fluid may cause transmission damage.

Alternative Engine Oil for Extremely Cold Climates

To improve engine cold start performance, we recommend that you use the following alternative engine oil in extremely cold climates, where the ambient temperature reaches -22.0°F (-30°C) or below.

Name	Specification
Motorcraft® SAE 0W-20 Premium Synthetic Blend Motor Oil: Engine oil - SAE 0W-20 XO-0W20-QSP	WSS-M2C947-A

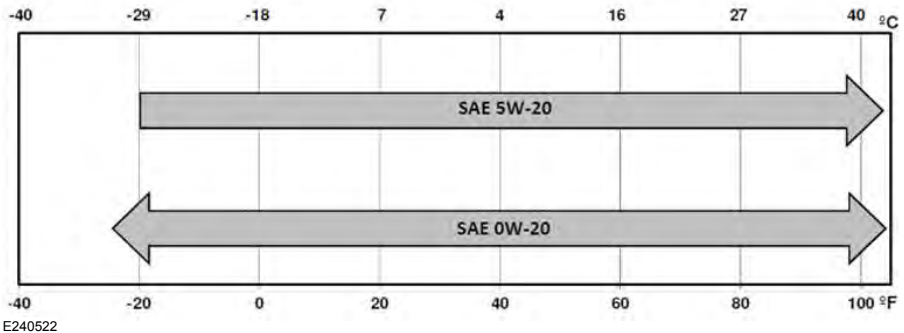

We recommend Motorcraft® motor oil for your vehicle. If Motorcraft® oil is not available, use motor oils of the recommended viscosity grade that meet API SN requirements and display the API Certification Mark for gasoline engines. Do not use oil labeled with API SN service category unless the label also displays the API certification mark.

Audio System

GENERAL INFORMATION

Radio Frequencies and Reception Factors

AM and FM frequencies are established by the Federal Communications Commission (FCC) and the Canadian Radio and Telecommunications Commission (CRTC). Those frequencies are:

- AM: 530, 540-1700, 1710 kHz
- FM: 87.9-107.7, 107.9 MHz

Radio Reception Factors	
Distance and strength	The further you travel from an AM or FM station, the weaker the signal and the weaker the reception.
Terrain	Hills, mountains, tall buildings, bridges, tunnels, freeway overpasses, parking garages, dense tree foliage and thunderstorms can interfere with the reception.
Station overload	When you pass a ground-based broadcast repeating tower, a stronger signal may overtake a weaker one and result in the audio system muting.

CD and CD Player Information

Note: *CD units play commercially pressed 4.7 in (12 cm) audio compact discs only. Due to technical incompatibility, certain recordable and re-recordable compact discs may not function correctly when used in Ford CD players.*

Note: *Do not insert CDs with homemade paper (adhesive) labels into the CD player as the label may peel and cause the CD to become jammed. You should use a permanent felt tip marker rather than adhesive labels on your homemade CDs. Ballpoint pens may damage CDs. Please contact an authorized dealer for further information.*

Note: *Do not use any irregularly shaped discs or discs with a scratch protection film attached.*

Always handle discs by their edges only. Clean the disc with an approved CD cleaner only. Wipe it from the center of the disc toward the edge. Do not clean in a circular motion.

Do not expose discs to direct sunlight or heat sources for extended periods.

MP3 and WMA Track and Folder Structure

Audio systems capable of recognizing and playing MP3 and WMA individual tracks and folder structures work as follows:

- There are two different modes for MP3 and WMA disc playback: MP3 and WMA track mode (system default) and MP3 and WMA folder mode.
- MP3 and WMA track mode ignores any folder structure on the MP3 and WMA disc. The player numbers each MP3 and WMA track on the disc (noted by the MP3 or WMA file extension) from T001 to a maximum of T255. The maximum number of playable MP3 and WMA files may be less depending on the structure of the CD and exact model of radio present.

Audio System

- MP3 and WMA folder mode represents a folder structure consisting of one level of folders. The CD player numbers all MP3 and WMA tracks on the disc (noted by the MP3 or WMA file extension) and all folders containing MP3 and WMA files, from F001 (folder) T001 (track) to F253 T255.
- Creating discs with only one level of folders helps with navigation through the disc files.

If you are burning your own MP3 and WMA discs, it is important to understand how the system reads the structures you create. While various files may be present (files with extensions other than MP3 and WMA), only files with the MP3 and WMA extension are played; other files are ignored by the system. This enables you to use the same MP3 and WMA disc for a variety of tasks on your work computer, home computer and your in-vehicle system.

In track mode, the system displays and plays the structure as if it were only one level deep (all MP3 and WMA files play, regardless of being in a specific folder). In folder mode, the system only plays the MP3 and WMA files in the current folder.

AUDIO UNIT - VEHICLES WITH: AM/FM/CD/SYNC

WARNING



Driving while distracted can result in loss of vehicle control, crash and injury. We strongly recommend that you use extreme caution when using any device that may take your focus off the road. Your primary responsibility is the safe operation of your vehicle. We recommend against the use of any hand-held device while driving and encourage the use of voice-operated systems when possible. Make sure you are aware of all applicable local laws that may affect the use of electronic devices while driving.

Note: Depending on your vehicle option package, your system may look different from what you see here.

Note: Some features, such as SIRIUS satellite radio, may not be available in your location. Check with an authorized dealer.

Audio System

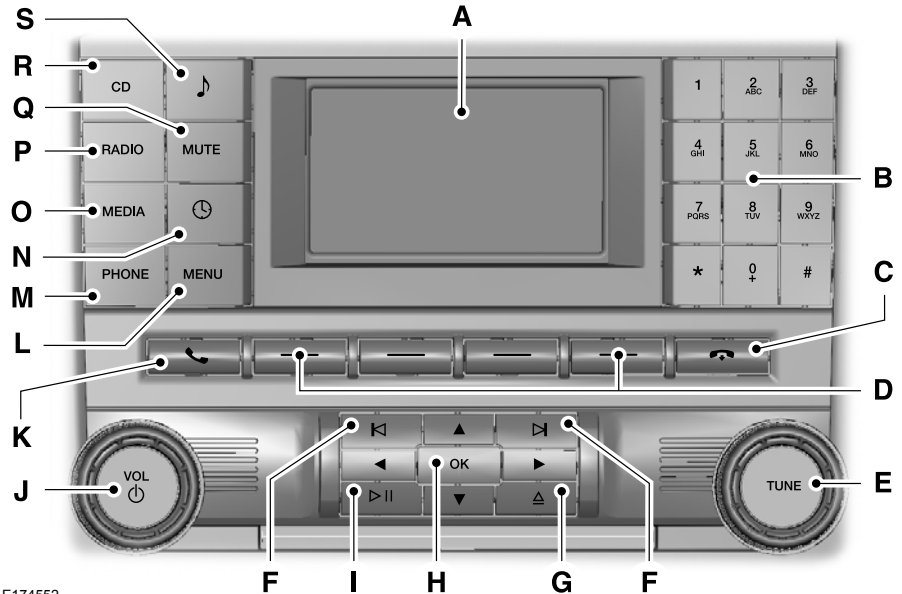

E174552

- A **Display screen:** Shows audio and SYNC information.
- B **Number block:** In radio mode, store and recall your favorite radio stations. To store a radio station, tune to the station, then press and hold a preset button until sound returns. In CD mode, select a track. In phone mode, enter a phone number.
- C **End phone call:** Press to end a phone call.
- D **Function buttons:** Select different functions of the audio system depending on which mode you are in (such as Radio mode or CD mode).
- E **TUNE:** In radio mode, turn to search through the radio frequency band. In SIRIUS mode, turn to find the previous or next available satellite radio station.
- F **Seek, Fast Forward and Reverse:** In radio mode, select a radio station and press this button. The system stops at the next strongest station. Press and hold to move quickly to the next strong radio station or memory preset. In SIRIUS mode, press to select the next satellite radio station. If a specific category is selected (such as jazz, rock or news), press to find the next or previous station in the selected category. In CD mode, press to select the next or previous track. Press and hold to move quickly forward or backward through the current track.

Audio System

- G **Eject:** Press to eject a CD.
- H **OK and cursor arrows:** Press the up and down arrow buttons to select the various settings. When you make your selection, press the left and right arrow buttons to change the settings. Press **OK** to set, or press **MENU** to exit.
- I **Play/Pause:** Press to either play or pause a track when listening to a CD.
- J **Vol and Power:** Turn to adjust the volume. Press to switch the system on and off.
- K **Answer or make phone call:** Press to either answer or make a phone call.
- L **MENU:** Press to access different audio system features.
- M **PHONE:** Press to access the phone features of the SYNC system. See your SYNC information.
- N **Clock:** Press to access the clock setting. Use the center arrow controls to change the hours and minutes. You can also set the clock by pressing **MENU** and scrolling to Clock Settings.
- O **MEDIA:** Press to open the media source menu. You can press this multiple times to change to CD or to a SYNC-Media device or scroll through the media sources using the arrow buttons. Press **OK** to select a source.
- P **RADIO:** Press to listen to the radio or change radio stations. Press the function buttons below the radio screen to select different radio functions.
- Q **MUTE or SIRIUS:** Press to mute the playing audio, or if equipped, listen to SIRIUS satellite radio.
- R **CD:** Press to listen to a CD. Press the function buttons below the radio screen to select on-screen options of Repeat or Shuffle.
- S **SOUND:** Press to access settings for Treble, Midrange, Bass, Fade and Balance. Use the up and down arrow buttons to select the various settings. When you make your selection, press the left and right arrow buttons to change the settings. Press **OK** to set or press **MENU** to exit. Sound settings can be set for each audio source independently.

Menu Structure

Note: Depending on your system, some options may appear slightly different.

Press **MENU**.

Press the up and down arrow buttons to scroll through the options.

Press the right arrow to enter a menu.
Press the left arrow to exit a menu.

Press **OK** to confirm a selection.

Audio System

Radio	
Manual Tune	Use the left and right arrows to go up or down the frequency band.
Scan	Select for a brief sampling of all available channels.
AST	Select to store the six strongest local stations on the AM-AST and FM-AST frequency bands.
Set Category for Seek/Scan	Select to have the system search by certain music categories (such as Rock, Pop or Country).
RDS Text Display	Select to view additional broadcast data, if available. This feature defaults to off. RBDS must be on for you to set a category.

SIRIUS	
Scan	Select for a brief sampling of all available channels.
Electronic Serial Number (ESN)	Select to view your satellite radio electronic serial number (ESN). You will need this number when communicating with SIRIUS to activate, modify or track your account.
Check Channel Guide	Select to view available satellite radio channels. Press OK to open a list of the following options for this channel. Once you skip or lock a channel, you can only access it by pressing Direct Tune and entering the channel number. Locking or unlocking a channel requires your PIN.
Set Category for Seek/Scan	Select to view channel categories (such as Pop, Rock or News). If you select a category, seek and scan functions only stop on channels in that category.
Alerts	Select to switch alerts on or off for songs, artists or teams. The system alerts you when the selection is playing on another channel. Save up to 20 alerts.
Unlock All Stations	Use your PIN to unlock previously locked stations.
Skip No Stations	Use to restore any channels you previously skipped.
Parental Lockout	Select to create a PIN, which allows you to lock or unlock channels. Your initial PIN is 1234.

Audio System

Audio Settings	
Speed Compensated Volume	Automatically adjusts the volume to compensate for speed and wind noise. You can set the system between 0 and +7.
Sound	Select to adjust settings for Treble, Midrange, Bass, Fade or Balance.
Occupancy Mode	Select to optimize sound quality for the chosen seating position.
DSP	Choose between the stereo modes.

CD Settings	
Scan All	Select to scan all disc selections.
Scan Folder	Select to scan all music in the current MP3 folder.
CD Compression	Select to bring soft and loud passages together for a more consistent listening level.

Clock Settings	
Set Date and Time	Select to set the time and calendar date.
24 Hour	Select to view clock time in a 12-hour mode or 24-hour mode.

Display Settings	
Brightness	Select to change display brightness.
Language	Select to display the language in English, French or Spanish.
Temp. Setting	Select to display the outside temperature in Fahrenheit or Celsius.

Audio System

AUDIO UNIT - VEHICLES WITH: AM/FM/CD/SYNC/ TOUCHSCREEN DISPLAY

WARNING



Driving while distracted can result in loss of vehicle control, crash and injury. We strongly recommend that you use extreme caution when using any device that may take your focus off the road. Your primary responsibility is the safe operation of your vehicle. We recommend against the use of any hand-held device while driving and encourage the use of voice-operated systems when possible. Make sure you are aware of all applicable local laws that may affect the use of electronic devices while driving.

Note: *The touchscreen system controls most of the audio features. See your SYNC information.*

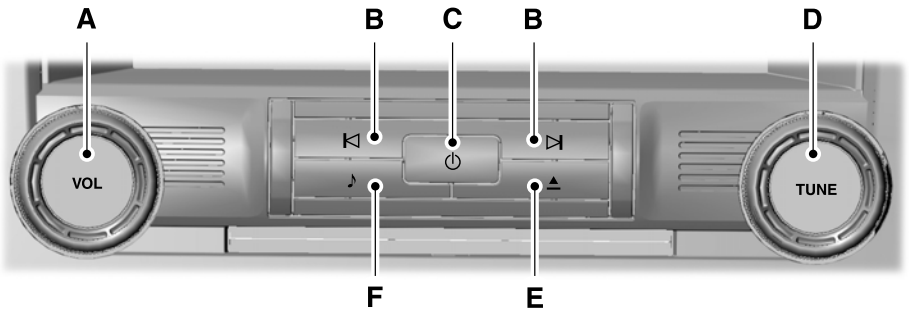

E248781

- A **VOL:** Turn to adjust the system volume.
- B **Seek, Fast Forward and Reverse:** In radio mode, select a radio station and press this button. The system stops at the next strongest station. Press and hold to move quickly to the next strong radio station or memory preset. In CD mode, press to select the next or previous track. Press and hold to move quickly forward or backward through the current track.
- C **Power:** Press to switch the system on and off.

Audio System

- D **TUNE:** Turn to search through the radio frequency band.
- E **Eject:** Press to eject a CD.
- F **Sound:** Press to access settings for Treble, Midrange, Bass, Fade or Balance.

DIGITAL RADIO

Note: *HD Radio broadcasts are not available in all markets.*

HD Radio technology is the digital evolution of analog AM/FM radio. Your system has a special receiver that allows it to receive digital broadcasts (where available) in addition to the analog broadcasts, it already receives. Digital broadcasts provide a better sound quality than analog broadcasts with free, crystal-clear audio and no static or distortion. For more information, and a guide to available stations and programming, please visit www.hdradio.com.

When HD Radio is on and you tune to a station broadcasting HD Radio technology, you may notice the HD Radio logo on your screen. When this logo is available, you may also see Title and Artist fields on-screen.

The multicast indicator appears in FM mode (only) if the current station is broadcasting multiple digital broadcasts. The highlighted numbers signify available digital channels where new or different content is available. HD1 signifies the main programming status and is available in analog and digital broadcasts. Other multicast stations (HD2 through HD7) are only available digitally.

When HD Radio broadcasts are active, you can access the following functions:

- **Scan** allows you to hear a brief sampling of all available stations. This feature still works when HD Radio reception is on, although it does not scan for HD2-HD7 channels. You may see the HD logo appear if the station has a digital broadcast.
- **Memory presets** allow you to save an active channel as a memory preset. Touch and hold a memory preset slot until the sound returns. There is a brief mute while the radio saves the station. Sound returns when finished. When switching to an HD2 or HD3 memory preset, the sound mutes before the digital audio plays, because the system has to reacquire the digital signal.

Note: *As with any saved radio station, you cannot access the saved station if your vehicle is outside the station's reception area.*

Audio System

HD Radio Reception and Station Troubleshooting

Potential reception issues	
Reception area	If you are listening to a multicast station and you are on the fringe of the reception area, the station may mute due to weak signal strength.
	If you are listening to HD1, the system switches back to the analog broadcast until the digital broadcast is available again. However, if you are listening to any of the possible HD2-HD7 multicast channels, the station mutes and stays muted unless it is able to connect to the digital signal again.
Station blending	When the system first receives a station (aside from HD2-HD7 multicast stations), it first plays the station in the analog version. Once the receiver verifies the station is an HD Radio station, it shifts to the digital version. Depending on the station quality, you may hear a slight sound change when the station changes from analog to digital. Blending is the shift from analog to digital sound or digital back to analog sound.

In order to provide the best possible experience, use the contact form to report any station issues found while listening to a station broadcasting with HD Radio technology. Independent entities own and operate each station. These stations are responsible for ensuring all audio streams and data fields are accurate.

Audio System

Potential station issues		
Issues	Cause	Action
Echo, stutter, skip or repeat in audio. Increase or decrease in audio volume.	This is poor time alignment by the radio broadcaster.	No action required. This is a broadcast issue.
Sound fading or blending in and out.	The radio is shifting between analog and digital audio.	No action required. The reception issue may clear up as you continue to drive.
There is an audio mute delay when selecting HD2 or HD3, multicast preset or Direct Tune .	The digital multicast is not available until the HD Radio broadcast is decoded. Once decoded, the audio is available.	No action required. This is normal behavior. Wait until the audio is available.
Cannot access HD2 or HD3 multicast channel when recalling a preset or from a direct tune.	The previously stored multicast preset or direct tune is not available in your current reception area.	No action required. The station is not available in your current location.
Text information does not match currently playing audio.	Data service issue by the radio broadcaster.	Fill out the station issue form at website listed below.*
There is no text information shown for currently selected frequency.	Data service issue by the radio broadcaster.	Fill out the station issue form at website listed below.*
HD2-HD7 stations not found when Scan is pressed.	Pressing Scan disables HD2-HD7 channel search.	No action required. This is normal behavior.

* http://www.ibiquity.com/automotive/report_radio_station_experiences

HD Radio Technology manufactured under license from iBiquity Digital Corp. U.S. and foreign patents. HD Radio and the HD and HD Radio logos are proprietary trademarks of iBiquity Digital Corp. Ford Motor Company and iBiquity Digital Corp. are not responsible for the content sent using HD Radio technology. Content may be changed, added or deleted at any time at the station owner's discretion.

SATELLITE RADIO (If Equipped)

SIRIUS® broadcasts a variety of music, news, sports, weather, traffic and entertainment satellite radio channels. For more information and a complete list of SIRIUS satellite radio channels, visit www.siriusxm.com in the United States, www.siriusxm.ca in Canada, or call SIRIUS at 1-888-539-7474.

Audio System

Note: This receiver includes the eCos real-time operating system. eCos is published under the eCos License.

Satellite Radio Reception Factors

Potential satellite radio reception issues	
Antenna obstructions	For optimal reception performance, keep the antenna clear of snow and ice build-up and keep luggage and other material as far away from the antenna as possible.
Terrain	Hills, mountains, tall buildings, bridges, tunnels, freeway overpasses, parking garages, dense tree foliage and thunderstorms can interfere with your reception.
Station overload	When you pass a ground-based broadcast-repeating tower, a stronger signal may overtake a weaker one and the audio system may mute.
Satellite radio signal interference	Your display may show ACQUIRING . . . to indicate the interference and the audio system may mute.

SIRIUS® Satellite Radio Service

Note: SIRIUS reserves the unrestricted right to change, rearrange, add or delete programming including canceling, moving or adding particular channels, and its prices, at any time, with or without notice to you. Ford Motor Company shall not be responsible for any such programming changes.



E208625

SIRIUS satellite radio is a subscription-based satellite radio service that broadcasts a variety of music, sports, news, weather, traffic and entertainment programming. Your factory-installed SIRIUS satellite radio system includes hardware and a limited subscription term, which begins on the date of sale or lease of your vehicle. See an authorized dealer for availability.

For more information on extended subscription terms (a service fee is required), the online media player and a complete list of SIRIUS satellite radio channels, and other features, please visit www.siriusxm.com in the United States, www.siriusxm.ca in Canada, or call SIRIUS at 1-888-539-7474.

Satellite Radio Electronic Serial Number (ESN)

You need your ESN to activate, modify or track your satellite radio account. When in satellite radio mode, tune to channel 0.

Audio System

Troubleshooting

Message	Condition	Action
Acquiring...	Radio requires more than two seconds to produce audio for the selected channel.	No action required. This message should disappear shortly.
Satellite antenna fault SIRIUS system failure	There is an internal module or system failure present.	If this message does not clear shortly, or with an ignition key cycle, your receiver may have a fault. See an authorized dealer for service.
Invalid Channel	The channel is no longer available.	Tune to another channel or choose another preset.
Unsubscribed Channel	Your subscription does not include this channel.	Contact SIRIUS at 1-888-539-7474 to subscribe to the channel, or tune to another channel.
No Signal	The signal is lost from the SIRIUS satellite or SIRIUS tower to your vehicle antenna.	The signal is blocked. When you move into an open area, the signal should return.
Updating...	Update of channel programming in progress.	No action required. The process may take up to three minutes.
Questions? Call 1-888-539-7474	Your satellite service is no longer available.	Contact SIRIUS at 1-888-539-7474 to resolve subscription issues.
None found Check Channel Guide	All the channels in the selected category are either skipped or locked.	Use the channel guide to turn off the Lock or Skip function on that station.
Subscription Updated	SIRIUS has updated the channels available for your vehicle.	No action required.

Audio System

USB PORT (If Equipped)

WARNING



Driving while distracted can result in loss of vehicle control, crash and injury. We strongly recommend that you use extreme caution when using any device that may take your focus off the road. Your primary responsibility is the safe operation of your vehicle. We recommend against the use of any hand-held device while driving and encourage the use of voice-operated systems when possible. Make sure you are aware of all applicable local laws that may affect the use of electronic devices while driving.



E201595

The USB port allows you to plug in media playing devices, memory sticks and charge devices (if supported). See your SYNC information.

GENERAL INFORMATION

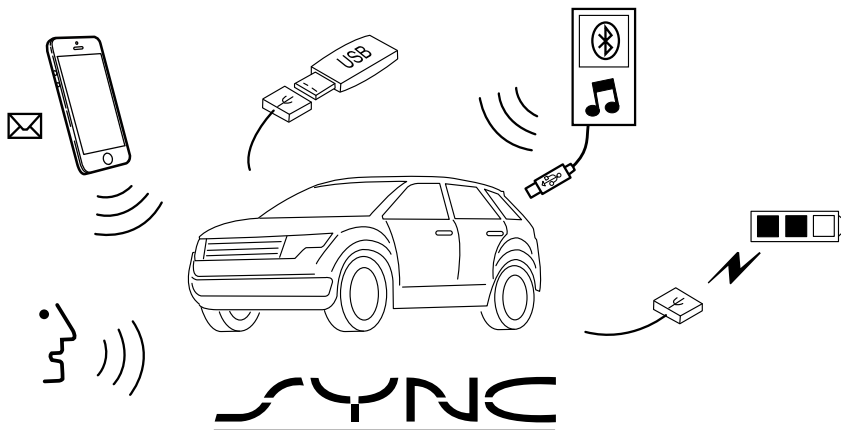

E198355

SYNC is an in-vehicle communications system that works with your Bluetooth-enabled cellular phone and portable media player. This allows you to:

- Make and receive calls.
- Access and play music from your portable music player.
- Use 911 Assist and applications, such as Spotify and Glympse, via SYNC AppLink.*
- Access phonebook contacts and music using voice commands.
- Stream music from your connected phone.
- Text message.

- Use the advanced voice recognition system.
- Charge your USB device (if your device supports this).

*These features are not available in all markets and may require activation. Available AppLink enabled apps vary by market.

Make sure that you review your device's manual before using it with SYNC.

Support

The SYNC support team is available to help you with any questions you cannot answer on your own.

Monday-Saturday, 8:30am-9:00pm EST.

Sunday, 10:30am-7:30pm EST.

In the United States, call 1-800-392-3673.

In Canada, call 1-800-565-3673.

Times are subject to change due to holidays.

SYNC Owner Account

Why do I need a SYNC owner account?

- Essential for keeping up with the latest software downloads available for SYNC.
- Access to customer support for any questions you may have.

Driving Restrictions

For your safety, certain features are speed-dependent and restricted when your vehicle is traveling over 3 mi (5 km).

Safety Information

WARNING



Driving while distracted can result in loss of vehicle control, crash and injury. We strongly recommend that you use extreme caution when using any device that may take your focus off the road. Your primary responsibility is the safe operation of your vehicle. We recommend against the use of any hand-held device while driving and encourage the use of voice-operated systems when possible. Make sure you are aware of all applicable local laws that may affect the use of electronic devices while driving.

When using SYNC:

- Do not operate playing devices if the power cords or cables are broken, split or damaged. Place cords and cables out of the way, so they do not interfere with the operation of pedals, seats, compartments or safe driving abilities.
- Do not leave playing devices in your vehicle during extreme conditions as it could cause them damage. See your device's manual for further information.
- Do not attempt to service or repair the system. See an authorized dealer.

Privacy Information

When a cellular phone is connected to SYNC, the system creates a profile within your vehicle that is linked to that cellular phone. This profile is created in order to offer you more cellular features and to operate more efficiently. Among other things, this profile may contain data about your cellular phone book, text messages (read and unread), and call history, including history of calls when your cellular phone was not connected to the system. In addition, if you connect a media device, the system creates and retains an index of supported media content. The system also records a short development log of approximately 10 minutes of all recent system activity. The log profile and other system data may be used to improve the system and help diagnose any problems that may occur.

The cellular profile, media device index, and development log will remain in the vehicle unless you delete them and are generally accessible only in the vehicle when the cellular phone or media player is connected. If you no longer plan to use the system or the vehicle, we recommend you perform a Master Reset to erase all stored information.

System data cannot be accessed without special equipment and access to the vehicle's SYNC module. Ford Motor Company and Ford of Canada will not access the system data for any purpose other than as described absent consent, a court order, or where required by law enforcement, other government authorities, or other third parties acting with lawful authority. Other parties may seek to access the information independently of Ford Motor Company and Ford of Canada. For further privacy information, see the section on 911 Assist. See **SYNC™ Applications and Services** (page 322).

USING VOICE RECOGNITION

This system helps you control many features using voice commands. This allows you to keep your hands on the wheel and focus on what is around you.

Initiating a Voice Session



Press the voice button. A list of available voice commands appears in the display.

Global Voice Commands

These voice commands are always available. You can say them at any time.

Global voice commands	
(cancel exit)	This command ends the voice session. You can also cancel a session by holding the voice button for two or more seconds.
help	This command provides you with hints, examples and instructions.
(main menu start again)	This command restarts the voice session from the initial starting point.

You can say any of the voice commands that appear within open and close brackets that are separated by |. For example, where; (cancel | exit) appears you say; cancel or exit.

Helpful Hints

- Make sure the interior of your vehicle is as quiet as possible. Wind noise from open windows and road vibrations may prevent the system from correctly recognizing spoken commands.
- Before giving a voice command, wait for the system announcement to finish, followed by a single tone. Any command spoken before this does not register with the system.
- Speak naturally, without long pauses between words.
- You can interrupt the system at any time while it is speaking by pressing the voice button. You can cancel a voice session by pressing and holding the voice button.

System Interaction and Feedback

The system provides feedback through audible tones, prompts, questions and spoken confirmations depending on the situation and the chosen level of interaction. You can customize the voice recognition system to provide more or less instruction and feedback.

The default setting is to a higher level of interaction in order to help you learn to use the system. You can change these settings at any time.

Adjusting the Interaction Level



Press the voice button. When prompted, say:

Voice Command	Action and Description
voice settings	
Then either of the following:	
interaction mode novice	Provides more detailed interaction and guidance. (Recommended for first time users.)
interaction mode advanced	Provides less audible interaction and guidance.

Confirmation Prompts

Confirmation prompts are short questions the system asks when it is not sure of your request or when there is more than one possible response to your request.

To adjust this setting press the voice button, when prompted say:

Voice Command	Action and Description
voice settings	
Then either of the following:	
confirmation prompts off	Make a best guess from the command; you may still occasionally be asked to confirm settings.
confirmation prompts on	Clarify your voice command with a short question.

Phone Confirmation

Using phone confirmations the system asks you to verify before placing any calls.

SYNC™ (If Equipped)

To adjust this setting press the voice button, when prompted say:

Voice Command	Action and Description
voice settings	
Then any of the following:	
phone confirmation on	When enabled, this feature will prompt you to confirm any voice initiated call command prior to the call being placed.
phone confirmation off	The system will make a best guess; you may still occasionally be asked to confirm settings.

Changing the Voice Settings

In addition to using voice commands to change the voice settings, you can also use the menu in the audio display.

To change the voice settings press the Menu button then select:

Menu Item
SYNC-Settings
Voice settings

Note: Depending on the current climate control settings, the fan speed may automatically go down while issuing voice commands or while making and receiving phone calls via SYNC to reduce the amount of background noise in the vehicle. The fan speed will automatically return to normal operation once the voice session ends. Fan speed can also be adjusted normally during a voice session, simply press fan buttons (or turn fan knob) to increase or decrease fan speed to desired setting.

To disable this automatic fan speed reduction feature during voice sessions, press and hold the climate control AC and Recirculated air buttons simultaneously, release and then increase fan speed within 2 seconds. To re-enable this feature, repeat the above sequence.

USING SYNC™ WITH YOUR PHONE

Hands-free calling is one of the main features of SYNC. While the system supports a variety of features, many are dependent on your cellular phone's functionality. At a minimum, most cellular phones with Bluetooth wireless technology support the following functions:

- Answering an incoming call.
- Ending a call.
- Using privacy mode.
- Dialing a number.
- Redialing.
- Call waiting notification.
- Caller ID.

Other features, such as text messaging using Bluetooth and automatic phonebook download, are phone-dependent features. To check your phone's compatibility, see your phone's manual and visit www.SYNCMyRide.com, www.SYNCMyRide.ca or www.syncmaroute.ca.

Pairing a Phone for the First Time

Wirelessly pairing your phone with SYNC allows you to make and receive hands-free calls.

Note: SYNC can support downloading up to approximately 4000 entries per Bluetooth-enabled cellular phone.

Note: Make sure to switch on the ignition and the radio. Shift the transmission into park (P) for automatic transmission or first gear for manual transmission.

Using the Audio System

Note: To scroll through the menus, press the up and down arrows on your audio system.

1. Make sure to switch on your phone's Bluetooth feature before starting the search. See your device's manual if necessary.
2. Press the **PHONE** button. When the audio display indicates there is no paired phone, select the option to add.
3. When a message to begin pairing appears in the audio display, search for SYNC on your phone to start the pairing process.

4. When prompted on your cell phone's display, confirm that the PIN provided by SYNC matches the PIN displayed on your cell phone. Your phone is now paired and the display indicates that the pairing was successful. If you are prompted to enter a PIN on your device, enter the PIN displayed on the screen. The display indicates when the pairing is successful.

Depending on your phone's capability and your market, the system may prompt you with questions, such as setting the current phone as the primary phone (the phone SYNC automatically tries to connect with first upon vehicle start-up) and downloading your phonebook.

Using Voice Commands



Make sure to switch on your phone's Bluetooth feature before starting the search. See your device's manual if necessary.

Press the voice and when prompted say:

Voice Command	Action and Description
(pair ([Bluetooth] device phone Bluetooth audio) add phone)	Follow the instructions on the audio display.

You can say any of the voice commands that appear within open and close brackets that are separated by |. For example, where; (what's | what is) appears you say; what's or what is.

The commands that have [] around the word means that the word is optional.

SYNC™ (If Equipped)

Depending on your phone's capability and your market, the system may prompt you with questions, such as setting the current phone as the primary phone (the phone SYNC automatically tries to connect with first upon vehicle start-up) and downloading your phonebook.

Pairing Subsequent Phones

Note: Make sure to switch on the ignition and the radio. Shift the transmission into park (P) for automatic transmission or first gear for manual transmission.

Note: To scroll through the menus, press the up and down arrows on your audio system.

1. Make sure to switch on your phone's Bluetooth feature before starting the search. See your device's manual if necessary.
2. Press the **PHONE** button.
3. Select the option for Bluetooth Devices.
4. Press the **OK** button.
5. Select the option to add. This starts the pairing process.
6. When a message to begin pairing appears in the audio display, search for SYNC on your device.
7. When prompted on your cell phone's display, confirm that the PIN provided by SYNC matches the PIN displayed on your cell phone. Your phone is now paired and the display indicates that the pairing was successful. If you are prompted to enter a PIN on your device, enter the PIN displayed on the screen. The display indicates when the pairing is successful.

SYNC may prompt you with more cell phone options. Your cell phone may also prompt you to give SYNC permission to access information. For more information on your cell phone's capability, see your cell phone's manual and visit the website.

Phone Voice Commands



Press the voice button. When prompted, say any of the following:

Voice Command	
(phone Blackberry iPhone)	
Then say any of the following:	
call (___)	
call ___ at home	
call ___ ((in at) [the] office at work)	
call ___ on (cell mobile)	
call ___ on other	
dial [[a] number]	1
([go to] privacy transfer to phone privacy on)	2
(hold call [on] place call on hold)	2
join (calls call)	2
mute call [on]	2
(mute call off un-mute call)	2
(turn ringer on silent mode off)	
(turn ringer off silent mode [on])	

Voice Command
[text] (messages message) ³
help

___ is a dynamic listing that should be the name of a contact in your phonebook. For example you could say "Call Home".

¹ See **Dial** table below.

² These commands are only valid while in a phone call.

³ See the text message table below.

Dial Commands

Press the voice button and when prompted say any of the following commands:

Voice Commands
411 (four-one-one), 911 (nine-one-one)
700 (seven hundred)
800 (eight hundred)
900 (nine hundred)
Clear (deletes all entered digits)
Delete (deletes last set of digits entered)
Number <0-9>
Plus
Pound (#)
Star (*)

Note: To exit dial mode, press and hold the phone button or press any button on the audio system.

To access text messages say:

Voice Command
[text] (messages message)
Then say any of the following:
(listen to read) ([text] message)
forward (text [text] message)
reply to (text [text] message)
call [sender]

Phonebook Hints

To hear how the SYNC system speaks a name browse phonebook, select a contact and press:

Menu Item
Hear it

Changing Devices Using Voice Commands

Using SYNC, you can easily access multiple phones, ipods, or USB devices. to switch devices say:

SYNC™ (If Equipped)

Voice Command	
(connect device) ____	You can state the name of the desired device, such as “My iPhone”; “My Galaxy” or “My iPod”. SYNC may ask you to confirm the type of device (Phone, USB, or Bluetooth Audio).

Making Calls



Press the voice button. When prompted, say:

Voice Command	
call [[a] name]	
dial [[a] number]	SYNC prompts you to say the numbers that you wish to dial. After you say the numbers, the system confirms it. You can then say:

When the system has stated the number, you say any of the following:

Voice Command	
(dial send)	This initiates the call.
(delete correct)	This erases the spoken digits.

To end the call, press the end call button

on the steering wheel or select the end call option in the audio display.

Receiving Calls

Accepting calls

When receiving a call, you can answer the call by pressing the accept call button on the steering wheel or use the screen.

To use the screen to accept a call select:

Menu Item
Accept

Rejecting Calls

When receiving a call, you can reject the call by pressing the reject call button on the steering wheel or use the screen.

To use the screen to reject a call select:

Menu Item
Reject

Ignore the call by doing nothing.

Phone Options during an Active Call

During an active call, you have more menu features that become available, such as putting a call on hold or joining calls.

To access this menu, choose one of the options available at the bottom of the audio display or select **More** to choose from the following options:

SYNC™ (If Equipped)

Menu Item	Description and action
Mic. off	Switch your vehicle's microphone off. To switch the microphone on, select the option again.
Privacy	Switch a call from an active hands-free environment to your cellular phone for a more private conversation. When selected, the audio display indicates the call is private.
Hold	Put an active call on hold. When selected, the audio display indicates the call is on hold.
Dial a number	Enter numbers using the audio system's numeric keypad (for example, numbers for passwords).
Join calls	Join two separate calls. The system supports a maximum of three callers on a multiparty or conference call. 1. Select the More option. 2. Access the desired contact through the system or use voice commands to place the second call. Once actively in the second call, select the More option. 3. Scroll to the option to join calls and press the OK button.
Phonebook	Access your phonebook contacts. 1. Select the More option. 2. Scroll to the option for phonebook and press the OK button. 3. Scroll through your phonebook contacts. 4. Press the OK button again when the desired contact appears in the audio display. 5. Press the OK button or dial button to call the selection.
Call History	Access your call history log. 1. Select the More option. 2. Scroll to the option for call history and press the OK button. 3. Scroll through your call history options (incoming, outgoing or missed). 4. Press the OK button again when the desired selection appears in the audio display. 5. Press the OK button or dial button to call the selection.

Accessing Features through the Phone Menu

You can access your call history, phonebook, sent text messages, as well as access phone and system settings.

1. Press the **PHONE** button to enter the phone menu.
2. Select one of the options available.

SYNC™ (If Equipped)

Display	Description and action
Dial a number	Enter numbers using the audio system's numeric keypad.
Phonebook	Access your downloaded phonebook. 1. Press the OK button to confirm and enter. You can use the options at the bottom of the screen to access an alphabetical category quickly. You can also use the letters on the audio system's numeric keypad to jump in the list. 2. Scroll through your phonebook contacts. 3. Press the OK button again when the desired selection appears in the audio display. 4. Press the OK button or dial button to call the selection.
Call History	Access any previously dialed, received or missed calls. 1. Press the OK button to select. 2. Scroll to select incoming, outgoing or missed calls. Press the OK button to make your selection. 3. Press the OK button or dial button to call the selection.
Speed Dial	Select 1 of 10 speed dial entries. To set a speed dial entry, go to the phonebook and then press and hold one of the numbers on the audio system's numeric keypad.
Text messaging	Send, download and delete text messages.
BT Devices	Access the option for Bluetooth Device menu listings (add, connect, set as primary, on or off, delete).
Phone settings	View various settings and features on your phone.

Text Messaging

Note: This is a phone-dependent feature.

SYNC allows you to receive, send, download and delete text messages. The system can also read incoming text messages to you so that you do not have to take your eyes off the road.

Receiving a Text Message

Note: This is a phone-dependent feature. Your phone must support downloading text messages using Bluetooth to receive incoming text messages.

Note: This is a speed-dependent feature and is only available when your vehicle is traveling at 3.1 mph (5 km/h) or less.

When a new message arrives, an audible tone sounds and the audio display indicates you have a new message.

To hear the message you can say:

Voice command	Description and action
(listen to read) ([text] message)	Select this option to have the system read the message to you.

Using the screen you also have the following options:

Menu Item	Description and action	
Ignore	Select this option, or do nothing, and the message goes into your text message inbox.	
View	Select the view option to open the text message. Once selected, you have the ability to have the message read to you, to view other messages. For additional options select:	
	More...	If you select this option, use the arrow button to scroll through the following options:
	Reply to sender	Press the OK button to access, and then scroll through a list of pre-defined messages to send.
	Call sender	Press the OK button to call the sender of the message.
	Forward msg.	Press the OK button to forward the message to anyone in your phonebook or call history. You can also choose to enter a number.

Sending, Downloading and Deleting Your Text Messages

1. Press the **PHONE** button.

2. Select the text messaging option, and then press the **OK** button.

Choose from the following options:

Menu Item	Description and action
New	Allows you to send a new text message based on a pre-defined set of 15 messages.
View	Allows you to read the full message and, in addition, provides the option to have the system read the message to you. To go to the next message, select the More option. This allows you to reply to the sender, call the sender or forward the message.
Delete	Allows you to delete current text messages from the system (not your cellular phone). The audio display indicates when the system has deleted all your text messages.
More...	Allows you to delete all messages or manually trigger a download of all unread messages from your cellular phone.

Sending a Text Message

Note: You can only send a text message to one recipient at a time.

1. Select the send option when the desired selection highlights in the audio display.
2. Select the confirmation option when the contact appears.
3. Press the OK button again to confirm when the system asks if you want to send the message. A pre-defined signature appears on each text message.

Note: You can send text messages either by choosing a contact from the phonebook and selecting the text option from the audio display or by replying to a received message in the inbox.

Accessing Your Phone Settings

These are phone-dependent features. Your phone settings allow you to access and adjust features such as your ring tone and text message notification, modify your phonebook, and set up automatic download.

1. Press the **PHONE** button.
2. Scroll until the phone settings option appears, and then press the **OK** button.

Scroll to select from the following options:

Menu Item	Description and action
Set as master	If this option is checked, the system uses the cellular phone as the master when there is more than one cellular phone paired to the system. This option can be changed for all cellular phones (not only the active phone) using the Bluetooth Devices menu.
Phone status	See the cellular phone name, provider name, cellular phone number, and signal level. When done, press the left arrow buttons to return to the phone status menu.
Set ringtone	Select which ringtone sounds during an incoming call (one of the system's tones or your cellular phone's). If your phone supports in-band ringing, your phone's ringtone sounds when you choose the cellular phone ringtone option. 1. Press the OK button to select and scroll to hear each ringtone. 2. Press the OK button to select a ringtone.
Text msg notify	Have the option of hearing an audible tone to notify you when a text message arrives. Press the OK button to switch the audible tone off or on.
Phonebook pref.	Modify the contents of your phonebook (such as add, delete or download). Press the OK button to select and scroll between the choices in the phonebook preferences table below.

SYNC™ (If Equipped)

Menu Item	Phonebook preferences	
Add contacts	Push the desired contacts on your cellular phone. See your device's manual on how to push contacts. Press the OK button to add more contacts from your phonebook.	
Delete	When a message asking you to delete appears, select the option to confirm. Press the OK button to delete the current phonebook and call history. The system takes you back to the menu for phone settings.	
Download now	Press the OK button to select and download your phonebook to the system.	
Auto-download	When automatic download is on, the system deletes any changes (additions or deletions) saved in the system since your last download.	
	When automatic download is off, the system does not download your phonebook when your cellular phone connects to SYNC.	
	You can only access your phonebook, call history and text messages when your paired cellular phone connects to the system. Check or uncheck this option to download your phonebook automatically each time your phone connects to the system. Download times are phone-dependent and quantity-dependent.	
Sorting Pref.	Enabling this feature allows you to select how your contacts are displayed. You can select:	
	<table border="1"> <tr> <td>First/Last name</td> <td>Last/First name</td> </tr> </table>	First/Last name
First/Last name	Last/First name	

Bluetooth Devices

The Bluetooth Devices menu allows you to add, connect and delete devices as well as set a phone as primary.

1. Press the **PHONE** button.
2. Scroll until Bluetooth Devices appears, and then press the **OK** button.

Select from the following options:

Menu Item	Description and action
Add	Pair additional phones to the system. <ol style="list-style-type: none"> 1. Select the option to add to start the pairing process.

SYNC™ (If Equipped)

Menu Item	Description and action
	<p>2. When a message to begin pairing appears in the audio display, search for SYNC on your phone. See your phone's manual if necessary.</p> <p>3. When prompted on your cell phone's display, confirm that the PIN provided by SYNC matches the PIN displayed on your cell phone. Skip the next step. If you are prompted to enter a PIN on your device, it does not support Secure Simple Pairing. To pair, enter the PIN displayed on the screen. The display indicates when the pairing is successful.</p> <p>4. When the option to set the phone as primary appears, select either yes or no.</p> <p>5. SYNC may prompt you with more cell phone options. Your cell phone may also prompt you to give SYNC permission to access information. For more information on your cell phone's capability, see your cell phone's manual and visit the website.</p>
Delete	<p>Select the delete option and confirm when the system asks to delete the selected device. After deleting a phone from the list, you have to repeat the pairing process to pair it again.</p>
Master	<p>The system attempts to connect with the primary cellular phone each time you switch on the ignition. When you select a cellular phone as primary, it appears first in the list, marked with an asterisk. Set a previously paired phone as master by selecting the master option and confirming it as the primary.</p>
Conn.	<p>Connect a previously connected phone. You can only have one phone connected at a time to use the phone's functionality. When you connect another phone, the previous phone disconnects from the telephone services. The system allows you to use different Bluetooth devices for the cellular phone functionality and the Bluetooth audio music playback feature at the same time.</p>
Discon.	<p>Disconnects the selected cellular phone. Select this option and confirm when asked. After disconnecting a phone, you can reconnect it again without repeating the full pairing process.</p>

System Settings

1. Press the **MENU** button.

2. Select the SYNC settings option, and then press the **OK** button.

Scroll to select from the following options:

Display	Description and action
Bluetooth on	Check or uncheck this option to switch the system's Bluetooth interface off or on. Select this option, and then press the OK button to change the option's status.
Set defaults	Return to the factory default settings without erasing your indexed information (such as phonebook, call history, text messages and paired devices). Select this option and confirm when prompted in the audio display.
Master reset	Completely erase all information stored in the system (such as phonebook, call history, text messages and paired devices) and return to factory default settings.
Install on SYNC	Install downloaded applications or software updates. Select this option and confirm when prompted in the audio display. There must be a valid SYNC application or update available on the USB drive in order to finish an installation successfully.
System info	Display the system's version numbers as well as its serial number. Press the OK button to select.
Voice settings	The voice settings submenu contains various options. See Using Voice Recognition (page 308).
Browse USB	Browse the actual menu structure of the connected USB device. Press the OK button and use the up and down arrow buttons to scroll through the folders and files. Use the left or right arrow buttons to enter or leave a folder. You can select media content for playback from this menu.

SYNC™ APPLICATIONS AND SERVICES (If Equipped)

In order for the following features to work, your cellular phone must be compatible with SYNC. To check your phone's compatibility, visit www.SYNCMYRide.com, www.SYNCMYRide.ca or www.syncmaroute.ca.

- 911 Assist: Can alert 911 in the event of an emergency.
- SYNC AppLink: Allows you to connect to and use certain applications such as Spotify and Glmpse (if your phone is compatible).

These features may require activation. Available AppLink enabled apps vary by market.

911 Assist

WARNINGS



Unless the 911 Assist setting is set on before a crash, the system will not dial for help which could delay response time, potentially increasing the risk of serious injury or death after a crash.



Do not wait for 911 Assist to make an emergency call if you can do it yourself. Dial emergency services immediately to avoid delayed response time which could increase the risk of serious injury or death after a crash. If you do not hear 911 Assist within five seconds of the crash, the system or phone may be damaged or non-functional.



Always place your phone in a secure location in your vehicle so it does not become a projectile or get damaged in a crash. Failure to do so may cause serious injury to someone or damage the phone which could prevent 911 Assist from working properly.

Note: The SYNC 911 Assist feature must be set on before the incident.

Note: The SYNC 911 Assist feature only operates in the U.S., Canada or in a territory in which 911 is the emergency number.

Note: Before setting this feature on, make sure that you read the 911 Assist Privacy Notice later in this section for important information.

Note: If any user switches 911 Assist to on or off, that setting applies for all paired phones. If 911 Assist is switched off, either a voice message plays or a display message or an icon comes on when your vehicle is started and after a previously paired phone connects.

Note: Every phone operates differently. While SYNC 911 Assist works with most cellular phones, some may have trouble using this feature.

If a crash deploys an airbag (excluding knee airbags and rear inflatable safety belts [if equipped]) or activates the fuel pump shut-off, your SYNC-equipped vehicle may be able to contact emergency services by dialing 911 through a paired and connected Bluetooth-enabled phone. You can learn more about the 911 Assist feature, visit www.SYNCMYRide.com, www.SYNCMYRide.ca or www.syncmaroute.ca.

See **Supplementary Restraints System** (page 37). Important information about airbag deployment is in this chapter.

See **Roadside Emergencies** (page 188). Important information about the fuel pump shut-off is in this chapter.

Setting 911 Assist On or Off

Press Menu then select

Menu Item	Action and Description
SYNC-Applications	
911 Assist	Select the desired option, on or off.

If you choose not to activate this feature you will have the following options:

Menu Item	Action and Description
Voice Reminder ON	Provides a display and voice reminder at phone connection at vehicle start.
Voice Reminder OFF	Provides a display reminder only without a voice reminder at phone connection.

To make sure that 911 Assist works properly:

- SYNC must be powered and working properly at the time of the incident and throughout feature activation and use.
- The 911 Assist feature must be set on before the incident.
- You must pair and connect a Bluetooth-enabled and compatible cell phone to SYNC.
- A connected Bluetooth-enabled phone must have the ability to make and maintain an outgoing call at the time of the incident.

- A connected Bluetooth-enabled phone must have adequate network coverage, battery power and signal strength.
- The vehicle must have battery power and be located in the U.S., Canada or in a territory in which 911 is the emergency number.

In the Event of a Crash

Not all crashes deploy an airbag or activate the fuel pump shut-off (the triggers for 911 Assist). If a connected cell phone sustains damage or loses its connection to SYNC during a crash, SYNC searches for and tries to connect to a previously paired cell phone; SYNC then attempts to call the emergency services.

Before making the call:

- SYNC provides a short window of time (about 10 seconds) to cancel the call. If you fail to cancel the call, SYNC attempts to dial 911.
- SYNC says the following, or a similar message: "SYNC will attempt to call 911, to cancel the call, press Cancel on your screen or press and hold the phone button on your steering wheel".

If you do not cancel the call, and SYNC makes a successful call, a pre-recorded message plays for the 911 operator, and then the occupant(s) in your vehicle is able to talk with the operator. Be prepared to provide your name, phone number and location immediately, because not all 911 systems are capable of receiving this information electronically.

911 Assist May Not Work If

- Your cellular phone or 911 Assist hardware sustains damage in a crash.
- The vehicle's battery or the SYNC system has no power.
- The phone(s) thrown from your vehicle are the ones paired and connected to the system.

911 Assist Privacy Notice

When you switch on 911 Assist, it may disclose to emergency services that your vehicle has been in a crash involving the deployment of an airbag or activation of the fuel pump shut-off. Certain versions or updates to 911 Assist may also be capable of electronically or verbally disclosing to 911 operators your vehicle location or other details about your vehicle or crash to assist 911 operators to provide the most appropriate emergency services. If you do not want to disclose this information, do not switch the feature on.

SYNC Mobile Apps

The system enables voice and steering wheel control of SYNC AppLink enabled smartphone apps. When an app is running through AppLink, you can control main features of the app through voice commands and steering wheel controls.

Note: You must pair and connect your smartphone to SYNC to access AppLink.

Note: iPhone users need to connect the phone to the USB port.

Note: Android users need to connect the phone to SYNC using Bluetooth.

Note: For information on available apps, supported smartphone devices and troubleshooting tips please visit the Ford website.

Availability of SYNC AppLink enabled Apps will vary by region.

Note: Make sure you have an active account for the app that you have downloaded. Some apps work automatically with no setup. Other apps want you to configure your personal settings and personalize your experience by creating stations or favorites. We recommend you do this at home or outside of your vehicle.

Note: AppLink is not available if your vehicle is equipped with the MyFordTouch system.

To Access Using the SYNC Menu

Press the MENU button to access the menu on-screen. Then select:

Menu Item	Action and Description
SYNC-Apps	
Mobile Apps	Scroll through the list of available applications and select a particular app or select:
	Find New Apps

Note: If you cannot find a compatible SYNC AppLink app, make sure the required app is running on the mobile device.

Accessing an App's Menu

When an app is running through SYNC, press the right arrow button on the steering wheel control to access the app menu.

You can access various app features from here, for example thumbs up and thumbs down.

Press the left arrow button on the steering wheel control to exit the app menu.

To Access Using Voice Commands

Press the voice button then when prompted say:

Menu Item	Action and Description
mobile (apps applications)	Say the name of the application after the tone. The app should start. When an app is running through SYNC, you can press the voice button and speak commands specific to the app, for example "Play Playlist Road Trip".
help	Use this command to discover the available voice commands.

SYNC Mobile App Voice Commands

The following voice commands are always available:

Menu Item	Action and Description
mobile (apps applications)	SYNC prompts you to say the name of an app to start it on SYNC.
list [mobile] (apps applications)	SYNC lists all of the currently available mobile apps.
find [new] [mobile] (apps applications)	Searches your connected mobile device for SYNC-compatible mobile apps.
help	
You can say the name of a mobile app at any time to start the mobile app on SYNC.	

App Permissions

App permissions are organized by groups. You can grant these group permissions individually. You can change a permission group status any time when not driving, by using the settings menu.

When you launch an app using SYNC, the system may ask you to grant certain permissions, for example:

- To allow your vehicle to provide vehicle information to the app such as, but not limited to: Fuel level, fuel economy, fuel consumption, engine speed, rain sensor, odometer, VIN, external temperature, gear position, tire pressure, and head lamp status.
- To allow your vehicle to provide driving characteristic information such as, but not limited to: MyKey, seat belt status, engine revolutions per minute, gear position, braking events, steering wheel angle, and accelerator pedal position.

SYNC™ (If Equipped)

- To allow your vehicle to provide location information, including: GPS and speed.
- To allow the app to send push notifications using the vehicle display and voice capabilities while running in a background state. Push notifications may be particularly useful for news or

location based apps.

Note: *You only need to grant permissions the first time you use an app with SYNC.*

Note: *Ford is not responsible or liable for any damages or loss of privacy relating to usage of an app, or dissemination of any vehicle data that you approve Ford to provide to an app.*

Enabling and Disabling App Permissions Using the SYNC Menu

Press the MENU button to access the SYNC menu then select:

Menu Item	Action and Description
SYNC-Apps	
Mobile Apps	
All Apps	You can also select a specific app. If the app supports push notifications, this setting is listed. Select to enable or disable the feature as required.

Enabling SYNC Mobile Apps

In order to enable mobile apps, SYNC requires user consent to send and receive app authorization information and updates using the data plan associated with the connected device.

Data is sent to Ford in the United States through the connected device. The information is encrypted and includes your VIN, SYNC module number, anonymous usage statistics and debugging information. Updates may take place automatically.

Note: *You must enable mobile apps for each connected device the first time you select a mobile app using the system.*

Note: *Standard data rates apply. Ford is not responsible for any additional charges you may receive from your service provider, when your vehicle sends or receives data through the connected device. This includes any additional charges incurred due to driving in areas when roaming out of a home network.*

App Status

You can view the current status of an app in the settings menu.

SYNC™ (If Equipped)

There are three possible statuses:

Menu Item	Action and Description
Update Needed	The system has detected a new app requiring authorization or a general permissions update is required.
Up-To-Date	No update is required.
Updating...	The system is trying to receive an update.

Update settings

Menu Item	Action and Description
Request Update	Select this option from the settings menu to manually preform a needed update.
Disable Updates	Select this option from the settings menu to disable automatic updates. Doing so also disables the use of Mobile Apps on SYNC.

USING SYNC™ WITH YOUR MEDIA PLAYER

You can access and play music from your digital music player over your vehicle's speaker system using the system's media menu or voice commands. You can also sort and play your music by specific categories, such as artist and album.

Note: *The system is capable of indexing up to 15,000 songs.*

SYNC is capable of hosting nearly any digital media player including: iPod, Zune, plays from device players, and most USB drives. SYNC also supports audio formats, such as MP3, WMA, WAV and ACC.

Confirm that the USB device has been formatted correctly and has the following specifications:

- USB 2.0.
- File format must be FAT16/32.

The format of the audio files on the USB device must be:

- MP3.
- Non DRM protected WMA.
- WAV.
- AAC.

Connecting Your Digital Media Player to the USB Port

Note: *If your digital media player has a power switch, make sure you switch it on before plugging it in.*

To Connect Using Voice Commands

Plug the device into one of the vehicle's USB ports.

Press the voice button and when prompted, say:

Voice Command	Action and Description
(USB [stick] iPod MP3 [player])	You can now play music by saying any of the appropriate voice commands. See the media voice commands.

Words in brackets [] are optional and do not have to be spoken for the system to understand the command. For example, for where (USB [stick] | IPOD | MP3 [player]) appears, you can say USB or USB stick.

To view USB content select:

Message	Description and Action
Browse USB	Depending on how many media files are on your connected device, an indexing message may appear in the display. When indexing is complete, the selected source starts to playback audio automatically.

You can browse the files on the USB device in categories. Select BROWSE from the buttons at the bottom of the audio display and choose from the following:

Message
Play all
Playlists
Songs
Artists

To Connect Using the System Menu

1. Plug the device into one of the vehicle's USB ports.
2. Press the **MEDIA** button and select either USB 1 or USB 2 from the media source list in the audio display.

Message
Albums
Genres
Browse USB
Reset USB

Media Voice Commands



Press the voice button and when prompted say:

SYNC™ (If Equipped)

Voice Command	Description and Action
(USB [stick] iPod MP3 [player])	You can now play music by saying any of the appropriate voice commands.

You can say any of the voice commands that appear within open and close brackets that are separated by |. For example, where; (what's | what is) appears you say; what's or what is.

You must say any of the voice commands that appear outside of open and close brackets. For example, where; (what's | what is) playing, you must say either "what's playing" or "what is playing".

Command	Description and Action
pause	Pauses device playback.
play	Resumes device playback.
play [album] ___	
play all	Play all media on the device from the first track to the last.
play [artist] ___	
play [genre] ___	
play [playlist] ___	
next [track title song file podcast chapter episode]	Plays the next track on the current media.
previous [track title song file podcast chapter episode]	Plays the previous track on current media.
[play] (similar music more like this)	Creates a playlist with a similar genre to the one currently playing.
play [song track title file] ___	
repeat off	
repeat (one track) [on]	Repeats the current track.

SYNCTM (If Equipped)

Command	Description and Action
shuffle [all] [on]	Plays the current playlist in a random order. (Not all devices support this command.)
shuffle off	
((who's who is) this who plays this (what's what is) playing [now] (what which) (song track artist) is this (who's who is) playing (what's what is) this)	At any time during playback, you can press the voice button and ask the system what is playing. The system reads the metadata tags (if populated) of the current track.

___ is a dynamic listing, meaning that it could be the name of anything, such as a group, artist or song. For example you could say "Play artist The Beatles".

Examples of USB Commands

SYNCTM provides the user with many intuitive ways to find and play a song using voice. For example, if we have a song called "Penny Lane" from the album "Magical Mystery Tour" we can say the following to play this song:

- Play song "Penny Lane".
- Play "Penny Lane".

If we wanted to play the entire album, we can say:

Voice Command
pause
play
next [track title song file podcast chapter episode]
previous [track title song file podcast chapter episode]

Media Menu Features

The media menu allows you to select how to play your music (such as by artist, genre, shuffle or repeat), find similar music or reset the index of your USB devices.

- Play album "Magical Mystery Tour".
- Play "Magical Mystery Tour".

Bluetooth Audio

The system is also capable of playing music from your cellular phone through Bluetooth.

To switch the Bluetooth Audio on, press the MEDIA button and select:

Menu Item
BT audio

Then any of the following:

Press the **MEDIA** button and select either USB 1 or USB 2 from the media source list in the audio display to start USB playback.

SYNC™ (If Equipped)

Message	Description and Action
Options	This will enter the media menu.

Then any of the following:

Message	Description and Action
Shuffle	Choose to shuffle or repeat your music. Once you make your choice, it remains on until you switch it off.
Repeat track	Choose to shuffle or repeat your music. Once you make your choice, it remains on until you switch it off.
Similar music	You can play similar types of music to the current playlist from the USB port. The system uses the metadata information of each track to compile a playlist. The system then creates a new list of similar tracks and then begins playing. Each track must have the metadata tags populated for this feature. With certain playing devices, if your metadata tags are not populated, the tracks will not be available in voice recognition, the play menu or this option. However, if you place these tracks onto your playing device in mass storage device mode they are available in voice recognition, the play menu or this option. The system places unknowns into any unpopulated metadata tag.
Reset USB	Resets the USB index. After the new indexing is complete you can choose what to play from the USB song library.

Accessing Your USB Song Library

1. Plug the device into your vehicle's USB port.
2. Press the **MEDIA** button (next to the audio display) to select USB playback.

Message	Description and Action
Browse USB	This menu allows you to select and play your media files by artist, album, genre, playlist or track.

If there are no media files to access, the display indicates there is no media.

SYNC™ (If Equipped)

If there are media files, you have the following options:

Display	Description and Action
Play all	Play all indexed media files from your device one at a time in numerical order.* Press the OK button to select. The first track title appears in the display.
Playlists	Access your playlists (from formats like ASX, M3U, WPL, or MTP).* 1. Press the OK button to select. 2. Scroll to select the desired playlist, and then press the OK button.
Songs	Search for and play a specific indexed track.* 1. Press the OK button to select. 2. Scroll to select the desired track, and then press the OK button.
Artists	Sort all indexed media files by artist. The system then lists and plays all artists and tracks alphabetically.* 1. Press the OK button to select. 2. Scroll to select the desired artist, and then press the OK button.
Albums	Sort all indexed media files by album.* 1. Press the OK button to select. 2. Scroll to select the desired album, and then press the OK button.
Genres	Sort all indexed media files by genre (category) type.* 1. Press the OK button to select. 2. Scroll to select the desired genre, and then press the OK button.
Browse USB	Browse all supported media files on your media player connected to the USB port. You can only view media files that are compatible with SYNC. (Other files are not visible.) 1. Press the OK button to select.

SYNC™ (If Equipped)

Display	Description and Action
	2. Scroll to browse indexed media files on the device, and then press the OK button.
Reset USB	Resets the USB index. After the new indexing is complete, you can choose what to play from the USB song library.

*You can use the buttons at the bottom of the audio display to jump to a certain alphabetical category quickly. You can also use the letters on the audio system's numeric keypad to jump in the list.

Using Voice Commands

You can access and view your USB songs using voice commands.

Plug the device into your vehicle's USB port.

Press the voice button and when prompted, say any of the following commands:

Accessing and Viewing USB Media
(browse search show) all (album albums)
(browse search show) all (artist artists)
(browse search show) all (genre genres)
(browse search show) all (playlist playlists)
(browse search show) all (song songs title titles file files track tracks)
(browse search show) album ____
(browse search show) artist ____
(browse search show) genre ____
(browse search show) playlist ____

USB 2 (If Equipped)

Your vehicle may come equipped with an additional USB port. If so, USB 1 is located at the front of the vehicle at the bottom of the instrument panel. USB 2 is located inside the storage compartment of the vehicle's center console.

You can plug in an additional USB device into the second USB port.

You can access both USB devices by using voice commands.

To access a USB device press the voice button and when prompted say:

Voice command
USB 1
USB 2

Note: SYNC only supports one connected iOS (Apple) devices at a time (whichever one you plug in first). When you connect a second iOS device, the systems charges it, but does not support playback from it.

Bluetooth Devices and System Settings

You can access these menus using the audio display. See **Using SYNC™ With Your Phone** (page 310).

Voice Commands for Audio Sources

Your voice system allows you to change audio sources with a simple voice command.



Press the voice button and when prompted say:

Voice Command
(music audio entertainment) [system]
Below are a few examples of voice commands you can use.
[tune [to]] AM
[tune [to]] AM1
[tune [to]] AM (autostore AST autose)
[tune [to]] AM 2
Bluetooth (audio stereo)
(disc CD [player]) play
[tune [to]] FM
[tune [to]] FM1
[tune [to]] FM (autostore AST autose)
[tune [to]] FM 2
Radio
tune [to] SAT *
Sirius *
(USB [stick] iPod MP3 [player])

Voice Command
((who's who is) this who plays this (what's what is) playing [now] (what which) (song track artist) is this (who's who is) playing (what's what is) this)
help

* If equipped.

Radio Voice Commands



If you are listening to the radio, press the voice button, and then say any of the commands in the following table.

If you are not listening to the radio, press the voice button and, after the tone, say:

Voice Command
Radio
You can then say any of the following commands.
[tune [to]] AM
[tune [to]] AM1
[tune [to]] AM (autostore AST autose)
[tune [to]] AM 2
[tune [to]] (AM ___ ___ [AM])
[tune [to]] AM preset ___
[tune [to]] AM1 preset ___
[tune [to]] FM
[tune [to]] FM1
[tune [to]] FM (autostore AST autose) preset ___

SYNC™ (If Equipped)

Voice Command
[tune [to]] FM 2
[tune [to]] (FM ___ ___ [FM])
[tune [to]] FM preset ___
FM ___ HD ___ *
[tune [to]] FM 2 preset ___
HD ___ *
[tune [to]] preset ___
Tune
help

* If equipped.

Sirius Satellite Radio Voice Commands (If equipped)



To listen to Sirius satellite radio, press the voice button and, after the tone, say:

Voice Commands
Sirius

When you are listening to Sirius satellite radio, you can press the voice button, and say any of the commands in the following table.

Voice Commands
tune [to] SAT
[tune [to]] SAT 1
[tune [to]] SAT 2
[tune [to]] SAT 3
[tune [to]] preset ___
[tune [to]] SAT 1 preset ___

Voice Commands	
[tune [to]] SAT 2 preset ___	
[tune [to]] SAT 3 preset ___	
tune [to] [Sirius]	
Help	
[tune [to]] Sirius [channel] ___	You can say the channel number (0-233) to listen to that Sirius station.

CD Voice Commands



If you are listening to a CD, press the voice button, and then say any of the commands in the following table.

If you are not listening to a CD, press the voice button and, after the tone, say:

Voice Command
(disc CD [player]) play
You can then say any of the following commands.
pause
play
[play] next track
[play] previous track
[play change to] track [number] ___
repeat (track song) [on]
repeat folder [on]
repeat off
(shuffle random mix) [on (tracks songs) [on]]

SYNC™ (If Equipped)

Voice Command
(shuffle random mix) (CD [player] disc) [on]
(shuffle random mix) folder [on]
shuffle off

Use the website at any time to check your phone's compatibility, register your account and set preferences as well as access a customer representative via an online chat (during certain hours). Visit www.SYNCMyRide.com, www.SYNCMyRide.ca or www.syncmaroute.ca for more information.

SYNC™ TROUBLESHOOTING

Your SYNC system is easy to use. However, should questions arise, see the tables below.

Phone issues		
Issue	Possible cause(s)	Possible solution(s)
There is excessive background noise during a phone call.	The audio control settings on your phone may be affecting SYNC performance.	Review your phone's manual about audio adjustments.
During a call, I can hear the other person but they cannot hear me.	This may be a possible phone malfunction.	Try turning off the device, resetting the device, removing the device's battery, then trying again.
SYNC is not able to download my phonebook.	This is a phone-dependent feature. This may be a possible phone malfunction.	Go to the website to review your phone's compatibility. Try turning off the device, resetting the device or removing the device's battery, then trying again. Try pushing your phonebook contacts to SYNC by using the Add Contacts feature. Use the SYNCmyphone feature available on the website.
The system says Phonebook Downloaded but the phonebook in SYNC is empty or missing contacts.	This may be a limitation on your phone's capability.	Try pushing your phonebook contacts to SYNC by using the Add Contacts feature.

SYNC™ (If Equipped)

Phone issues		
Issue	Possible cause(s)	Possible solution(s)
		Turn off the Auto phone-book download setting.
Text messaging is not working on SYNC.	<p>This is a phone-dependent feature.</p> <p>This may be a possible phone malfunction.</p>	<p>Go to the website to review your phone's compatibility.</p> <p>Try turning off the device, resetting the device or removing the device's battery, then trying again.</p>

USB and media issues		
Issue	Possible cause(s)	Possible solution(s)
I am having trouble connecting my device.	This may be a possible device malfunction.	<p>Try turning off the device, resetting the device, removing the device's battery, then trying again.</p> <p>Make sure you are using the manufacturer's cable.</p> <p>Make sure you insert the USB cable correctly into the device and the USB port.</p> <p>Make sure that the device does not have an auto-install program or active security settings.</p>
SYNC does not recognize my device when I turn on the car.	This is a device limitation.	Make sure you are not leaving the device in your vehicle during very hot or cold temperatures.
Bluetooth audio does not stream.	This is a phone-dependent feature.	Review the device compatibility chart on the SYNC website to confirm your phone supports the Bluetooth audio streaming function.

SYNC™ (If Equipped)

USB and media issues		
Issue	Possible cause(s)	Possible solution(s)
	The device is not connected.	Make sure you correctly connect the device to SYNC, and that you have pressed play on your device.
SYNC does not recognize music that is on my device.	<p>Your music files may not contain the correct artist, song title, album or genre information.</p> <p>The file may be corrupted.</p> <p>The song may have copy-right protection, which does not allow it to play.</p>	<p>Make sure that all song details are populated.</p> <p>Some devices require you to change the USB settings from mass storage to MTP class.</p>

Voice command issues		
Issue	Possible cause(s)	Possible solution(s)
SYNC does not understand what I am saying.	<p>You may be using the wrong voice commands.</p> <p>You may be speaking too soon or at the wrong time.</p>	<p>Review the phone voice commands and the media voice commands at the beginning of their respective sections.</p> <p>After pressing the voice icon, wait until after the tone sounds and Listening appears before saying a command. Any command spoken before this does not register with the system.</p>
SYNC does not understand the name of a song or artist.	You may be using the wrong voice commands.	Review the media voice commands at the beginning of the media section.

SYNC™ (If Equipped)

Voice command issues		
Issue	Possible cause(s)	Possible solution(s)
	<p>You may be saying the name differently than the way you saved it.</p> <p>The system may not be reading the name the same way you are saying it.</p>	<p>Say the song or artist exactly as listed. If you say "Play Artist Prince", the system does not play music by Prince and the Revolution or Prince and the New Power Generation.</p> <p>Make sure you are saying the complete title, such as "California remix featuring Jennifer Nettles".</p> <p>If the song titles are in all CAPS, you have to spell them. LOLA requires you to say "L-O-L-A".</p> <p>Do not use special characters in the title. The system does not recognize them.</p>
<p>SYNC does not understand or is calling the wrong contact when I want to make a call.</p>	<p>You may be using the wrong voice commands.</p> <p>You may be saying the name differently than the way you saved it.</p>	<p>Review the Phone voice commands at the beginning of the phone section.</p> <p>Make sure you are saying the contacts exactly as they are listed. For example, if you save a contact as Joe Wilson, say "Call Joe Wilson".</p> <p>Using the SYNC phone menu, open the phonebook and scroll to the name SYNC is having trouble understanding. SYNC will read the name to you, giving you some idea of the pronunciation SYNC is expecting.</p>

SYNC™ (If Equipped)

Voice command issues		
Issue	Possible cause(s)	Possible solution(s)
	<p>The system may not be reading the name the same way you are saying it.</p> <p>Contacts in your phonebook may be very short and similar, or they may contain special characters.</p> <p>Your phonebook contacts may be in CAPS.</p>	<p>The system works better if you list full names, such as "Joe Wilson" rather than "Joe".</p> <p>Do not use special characters, such as 123 or ICE, as the system does not recognize them.</p> <p>If a contact is in CAPS, you have to spell it. JAKE requires you to say "Call J-A-K-E".</p>

AppLink issues		
Issue	Possible cause(s)	Possible solution(s)
<p>AppLink Mobile Applications: When I select "Find New Apps," SYNC does not find any applications.</p>	<p>An AppLink capable phone is not connected to SYNC.</p>	<p>Ensure you have a compatible smartphone; an Android with OS 2.3 or higher or an iPhone 3GS or newer with iOS 5.0 or higher. Additionally, ensure your phone is paired and connected to SYNC in order to find AppLink-capable apps on your device. iPhone users must also connect to SYNC's USB port with an Apple USB cable.</p>
<p>My phone is connected, but I still cannot find any apps.</p>	<p>AppLink-enabled apps are not installed and running on your mobile device.</p>	<p>Ensure you have downloaded and installed the latest version of the app from your phone's app store. Ensure the app is running on your phone. Some apps require you to register or</p>

SYNC™ (If Equipped)

AppLink issues		
Issue	Possible cause(s)	Possible solution(s)
		login on the app on the phone before using them with AppLink. Also, some may have a "Ford SYNC" setting, so check the app's settings menu on the phone.
My phone is connected, my app(s) are running, but I still cannot find any apps.	Sometime apps do not properly close and re-open their connection to SYNC, over ignition cycles, for example.	<p>Closing and restarting apps may help SYNC find the application if you cannot discover it inside the vehicle.</p> <p>On an Android device, if apps have an "Exit" or 'Quit' option, select that then restart the app. If the app does not have that option, you can also manually "Force Close" the app by going to the phone's settings menu, selecting 'Apps.' then finding the particular app and choosing 'Force stop.' Don't forget to restart the app afterwards, then select "Find New Apps" on SYNC.</p> <p>On an iPhone with iOS7+, to force close an app, double tap the home button then swipe up on the app to close it. Tab the home button again, then select the app again to restart it. After a few seconds, the app should then appear in SYNC's Mobile App's Menu.</p>
My Android phone is connected, my app(s) are running, I restarted them, but I still cannot find any apps.	There is a Bluetooth bug on some order versions of the Android operating system that may cause apps that were found on your previous vehicle drive to not be found again if you have not turned off Bluetooth.	Reset the Bluetooth on your phone by turning it off and then turning Bluetooth back on. If you are in your vehicle, SYNC should be able to automatically re-connect to your phone if you press the "Phone" button.

SYNC™ (If Equipped)

AppLink issues		
Issue	Possible cause(s)	Possible solution(s)
My iPhone phone is connected, my app is running, I restarted the app but I still cannot find it on SYNC.	The USB connection to SYNC may need to be reset.	Unplug the USB cable from the phone, wait a moment, and plug the USB cable back in to the phone. After a few seconds, the app should appear in SYNC's Mobile Apps Menu. If not, "Force Close" the application and restart it.
I have an Android phone. I found and started my media app on SYNC, but there is no sound or the sound is very low.	The bluetooth volume on the phone may be low.	Try increasing the Bluetooth volume of the device by using the device's volume control buttons which are most often found on the side of the device.
I can only see some of the AppLink apps running on my phone listed in SYNC's Mobile Apps Menu.	Some Android devices have a limited number of bluetooth ports apps can use to connect. If you have more AppLink apps on your phone than the number of available Bluetooth ports, you will not see all of your apps listed in SYNC's mobile apps menu.	Force close or uninstall the apps you do not want SYNC to find. If the app has a "Ford SYNC" setting, disable that setting in the app's settings menu on the phone.

SYNC System Reset

The SYNC system in your vehicle has System Reset feature that can be performed if the function of a SYNC feature is lost. This reset is intended to restore functionality and will not erase any information previously stored in the system (Such as paired devices, phonebook, call history, text messages, or user settings). To perform a System Reset, press and hold the Seek Up (>>) button while pressing and holding the Radio Power button. Release both buttons after 2-3 seconds. Please allow a few minutes for the reset to complete. After a few minutes has passed you can resume using the SYNC system.

SYNC™ 3 (If Equipped)

GENERAL INFORMATION

WARNING

 Driving while distracted can result in loss of vehicle control, crash and injury. We strongly recommend that you use extreme caution when using any device that may take your focus off the road. Your primary responsibility is the safe operation of your vehicle. We recommend against the use of any hand-held device while driving and encourage the use of voice-operated systems when possible. Make sure you are aware of all applicable local laws that may affect the use of electronic devices while driving.

Getting to Know Your System

The SYNC 3 system allows you to interact with a variety of features using the touchscreen and voice commands. By integrating with your Bluetooth-enabled phone, the touchscreen provides easy interaction with audio, multimedia, climate control, navigation, and your phone's SYNC 3 compatible apps.

Using the Touchscreen

To operate the touchscreen, you can simply touch the item or option that you want to select. The button changes color when you select it.

The SYNC 3 layout allows you to quickly select the feature you wish to use.



E205444

SYNCTM 3 (If Equipped)

Item	Menu Item	Action and Description
A	Status Bar	This bar displays icons and messages pertaining to current system activities including climate settings, voice commands and phone functions such as text messages.
B	Home	This button is available on the main screens. Pressing it takes you to the home screen view.
C	Clock	This shows the current time. You can set the clock manually or have it controlled by the vehicle's GPS location. See Settings (page 393).
D	Outside Temperature	This displays the current outside temperature.
E	Feature Bar	You can touch any of the buttons on this bar to select a feature.

The touchscreen allows you quick access to all of your comfort, navigation, communication and entertainment options. Using the status and feature bar you can quickly select the feature you want to use.

Note: *Your system is equipped with a feature that allows you to access and control audio features for 10 minutes after you switch the ignition off (and no doors open).*

The Status Bar

Additional icons also display in the status bar depending on market, vehicle options and current operation. If a feature is not active, the icon does not display. Certain icons may move to the left or right depending on what options are active.

SYNC™ 3 (If Equipped)

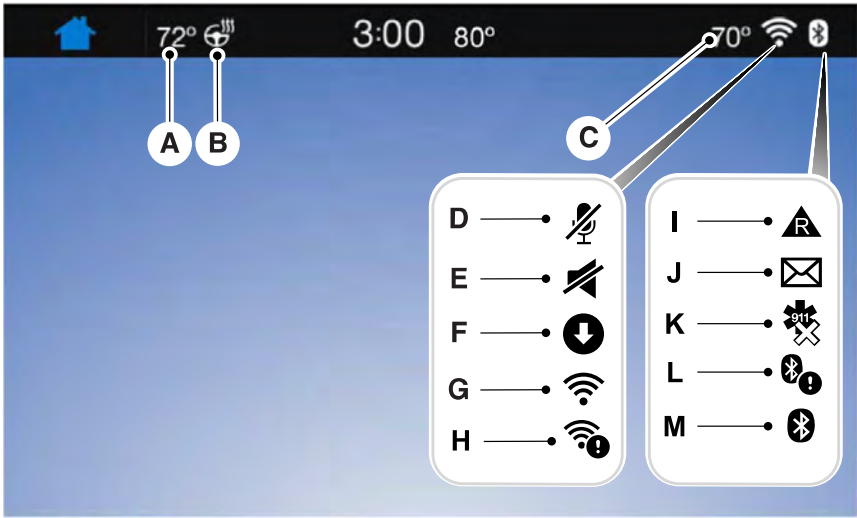

E223130

Callout	Item	Description
A	Driver Temperature	This shows the temperature the driver selects through the climate control system.
B	Heated steering wheel (If equipped)	When you activate the heated steering wheel option on the touch screen, this icon displays. It only displays when there is not a physical button for the heated steering wheel.
C	Passenger Temperature	When the passenger's temperature has been adjusted and is no longer linked to the driver's temperature, it displays here. If Dual is turned off and the temperatures are linked, the passenger's temperature does not display.
D	Microphone Mute	This icon displays when your phone's microphone is muted. A caller cannot hear you.
E	Mute	This icon displays when the audio system is muted.

SYNC™ 3 (If Equipped)

Callout	Item	Description
F	Download	This icon appears when SYNC 3 receives a software update. Pressing the icon shows more details about the new software.
G	Wi-Fi	This icon appears if a Wi-Fi network is connected.
H	Wi-Fi in Range	An available Wi-Fi network is within range.
I	Roaming	This icon displays when your cell phone is roaming.
J	Text Message	This icon displays when you receive a text message on your phone.
K	911 Assist Off	This icon displays when 911 Assist is set to off and your phone is connected to SYNC.
L	Bluetooth Alert	The Bluetooth alert icon displays when there is an active Bluetooth alert.
M	Bluetooth	This icon displays to show an active Bluetooth connection.

Messages may also appear in the status bar to provide you with notifications. You can select the message to view the associated feature.

Feature Bar

Feature Bar Item	Functions
Audio	Allows you to control the media playing in your vehicle. You can control all audio features including AM, FM and satellite radio, CDs, and media streaming over a Bluetooth device or through a USB connection.
Climate	Allows you to adjust the temperature, fan speed and airflow within the vehicle.
Phone	Allows you to make calls, receive calls, and access the phonebook of your connected device.

SYNC™ 3 (If Equipped)

Feature Bar Item	Functions
Navigation (If equipped)	Allows you to see your vehicle's location on a virtual road map, get driving directions to your destination and find points of interest along your route.
Apps	Connect and control SYNC 3 compatible apps running on your iPhone or Android device. Also, access built-in additional features such as SiriusXM Traffic and Travel Link (if equipped).
Settings	You can customize your system with various settings for the touchscreen display, feature preferences, and how you want to interact with your vehicle.

Cleaning the Touchscreen

You can remove fingerprints with a dry, clean, soft cloth.

If dirt or fingerprints are still on the screen, apply a small amount of alcohol to the cloth and try to clean it again.

Note: Do not use detergent or any type of solvent to clean the touchscreen.

Note: Do not pour or spray alcohol onto the touchscreen.

Using Voice Recognition

Using voice commands allows you to keep your hands on the wheel and focus on what is in front of you. The system provides feedback through audible tones, prompts, questions and spoken confirmations depending on the situation and the chosen level of interaction (voice settings).

The system also asks short questions (confirmation prompts) when it is not sure of your request or when there are multiple possible responses to your request.

When using voice commands, words and icons may appear in the status bar indicating the status of the voice command session. See **Using Voice Recognition** (page 356).

Using the Steering Wheel Controls

Depending on your vehicle and option package, you can use different controls on your steering wheel to interact with the touchscreen system in different ways.

VOL: Control the volume of audio output.

Mute: Mute the audio output.

Voice: Press to start a voice session. Press again to stop the voice prompt and immediately begin speaking. Press and hold to end a voice session.

SEEK NEXT:

- While in radio mode, press to seek between memory presets.
- While in USB, Bluetooth Audio or CD mode, press to seek between songs or press and hold to fast seek.

SYNC™ 3 (If Equipped)

SEEK PREVIOUS:

- While in radio mode, press to seek between memory presets.
- While in USB, Bluetooth Audio or CD mode, press to seek between songs or press and hold to fast seek.

PHONE ACCEPT: Press to answer a call or switch between calls.

PHONE REJECT: Press to end a call or reject an incoming call.

Note: On some models, **SEEK NEXT** may be combined with **PHONE REJECT** and **SEEK PREVIOUS** may be combined with **PHONE ACCEPT**.

M: Touch the control repeatedly to switch between media sources (modes).

See **Steering Wheel** (page 64).

Using Your Bezel Controls

Depending on your vehicle and option package, you may also have these controls on your instrument panel:

- **Power:** Switch the audio system on and off.
- **VOL:** Control the volume of playing audio.
- **Seek** and **Tune:** Use as you normally would in audio modes.
- **Eject:** Eject a CD from the audio system.
- **SOURCE** or **MEDIA:** Press repeatedly to advance through available media modes.
- **SOUND:** Press to access the Sound menu where you can adjust sound and other audio settings.
- **1-6:** Press and hold to store or press to select an AM, FM or SIRIUS memory preset. See **Audio System** (page 293).

- **DISP:** Switch the display on or off. You can also touch the screen to switch the display back on.
- **Temperature, fan and climate control buttons:** Control the temperature, fan speed or settings of the climate control system. See **SYNC™ 3** (page 344).

911 Assist

WARNINGS



Unless the 911 Assist setting is set on before a crash, the system will not dial for help which could delay response time, potentially increasing the risk of serious injury or death after a crash.



Do not wait for 911 Assist to make an emergency call if you can do it yourself. Dial emergency services immediately to avoid delayed response time which could increase the risk of serious injury or death after a crash. If you do not hear 911 Assist within five seconds of the crash, the system or phone may be damaged or non-functional.



Always place your phone in a secure location in your vehicle so it does not become a projectile or get damaged in a crash. Failure to do so may cause serious injury to someone or damage the phone which could prevent 911 Assist from working properly.

Note: The SYNC 911 Assist feature must be set on before the incident.

Note: The SYNC 911 Assist feature only operates in the U.S., Canada or in a territory in which 911 is the emergency number.

Note: Before setting this feature on, make sure that you read the 911 Assist Privacy Notice later in this section for important information.

SYNC™ 3 (If Equipped)

Note: If any user sets 911 Assist to on or off, that setting applies for all paired phones. If 911 Assist is switched off and the phone is connected to SYNC, an icon displays on the status bar.

Note: Every phone operates differently. While SYNC 911 Assist works with most cellular phones, some may have trouble using this feature.

If a crash deploys an airbag (excluding knee airbags and rear inflatable safety belts [if equipped]) or activates the fuel pump shut-off, your SYNC-equipped vehicle may be able to contact emergency services by dialing 911 through a paired and connected Bluetooth-enabled phone. You can learn more about the 911 Assist feature, by visiting:

Website
www.owner.ford.com www.syncmyride.ca www.syncmaroute.ca

See **Supplementary Restraints System** (page 37). Important information about airbag deployment is in this chapter.

See **Roadside Emergencies** (page 188). Important information about the fuel pump shut-off is in this chapter.

To switch 911 Assist on and off please view the settings information. See **Settings** (page 393).

To make sure that 911 Assist works correctly:

- SYNC must be powered and working properly at the time of the incident and throughout feature activation and use.
- The 911 Assist feature must be set on before the incident.
- You must pair and connect a Bluetooth-enabled and compatible cell phone to SYNC.

- A connected Bluetooth-enabled phone must have the ability to make and maintain an outgoing call at the time of the incident.
- A connected Bluetooth-enabled phone must have adequate network coverage, battery power and signal strength.
- The vehicle must have battery power and be located in the U.S., Canada or in a territory in which 911 is the emergency number.

In the Event of a Crash

Not all crashes will deploy an airbag or activate the fuel pump shut-off (the triggers for 911 Assist). If a connected cell phone sustains damage or loses its connection to SYNC during a crash, SYNC will search for and try to connect to a previously paired cell phone; SYNC will then attempt to call the emergency services.

Before making the call:

- SYNC provides a short window of time (about 10 seconds) to cancel the call. If you fail to cancel the call, SYNC attempts to dial 911.
- SYNC says the following, or a similar message: "SYNC will attempt to call 911, to cancel the call, press Cancel on your screen or press and hold the phone button on your steering wheel."

If you do not cancel the call, and SYNC makes a successful call, a pre-recorded message plays for the 911 operator, and then the occupant(s) in your vehicle is able to talk with the operator. Be prepared to provide your name, phone number and location immediately, because not all 911 systems are capable of receiving this information electronically.

SYNC™ 3 (If Equipped)

911 Assist May Not Work If

- Your cellular phone or 911 Assist hardware sustains damage in a crash.
- The vehicle's battery or the SYNC system has no power.
- The phone(s) thrown from your vehicle are the ones paired and connected to the system.

911 Assist Privacy Notice

When you switch on 911 Assist, it may disclose to emergency services that your vehicle has been in a crash involving the deployment of an airbag or activation of the fuel pump shut-off. Certain versions or updates to 911 Assist may also be capable of electronically or verbally disclosing to 911 operators your vehicle location or other details about your vehicle or crash to assist 911 operators to provide the most appropriate emergency services. If you do not want to disclose this information, do not switch the feature on.

Safety Information

WARNING



Driving while distracted can result in loss of vehicle control, crash and injury. We strongly recommend that you use extreme caution when using any device that may take your focus off the road. Your primary responsibility is the safe operation of your vehicle. We recommend against the use of any hand-held device while driving and encourage the use of voice-operated systems when possible. Make sure you are aware of all applicable local laws that may affect the use of electronic devices while driving.

- Do not attempt to service or repair the system. Have an authorized dealer check your vehicle.
- Do not operate playing devices if the power cords or cables are broken, split or damaged. Place cords and cables out of the way, so they do not interfere with the operation of pedals, seats, compartments or safe driving abilities.
- Do not leave playing devices in your vehicle during extreme conditions as it could cause them damage. See your device's user guide for further information.
- For your safety, some SYNC 3 functions are speed-dependent. Their use is limited to when your vehicle is traveling at speeds under 3 mph (5 km/h). Make sure that you review your device's manual before using it with SYNC 3.

Speed-restricted Features

Some features of this system may be too difficult to use while your vehicle is moving so they are restricted from use unless your vehicle is stationary.

- Screens crowded with information, such as Point of Interest reviews and ratings, SiriusXM Traffic and Travel Link sports scores, movie times or ski conditions.
- Any action that requires you to use a keyboard is restricted, such as entering a navigation destination or editing information.
- All lists are limited so the user can view fewer entries (such as phone contacts or recent phone call entries).

See the following chart for more specific examples.

SYNC™ 3 (If Equipped)

Restricted features	
Cellular Phone	Pairing a Bluetooth phone.
	Browsing of list entries is limited for phone contacts and recent phone calls.
System Functionality	Editing the keypad code.
	Enabling Valet Mode.
	Editing settings while the rear view camera or active park assist are active.
Wi-Fi	Editing Wi-Fi settings.
	Editing the list of wireless networks.
	Connecting to a new Wi-Fi network.
Text Messages	Viewing received text messages.
Navigation	Using the keyboard to enter a destination.
	Adding or editing Navigation Favorites entries or Avoid Areas.

Creating a SYNC Owner Account

Why do I need a SYNC owner account?

- Essential for keeping up with the latest software and connected features.
- Access to customer support for any questions you may have.
- Maintain account permissions.

Visit the website to sign up and register.

Website
www.owner.ford.com www.syncmyride.ca

Website
www.syncmaroute.ca

Updating Your System

You can choose to download the update onto a USB drive or use Wi-Fi to deliver automatic updates.

USB Updates

To use the USB update you need to log into your owner account and visit the SYNC software update page.

Website
www.owner.ford.com www.syncmyride.ca

SYNC™ 3 (If Equipped)

Website
www.syncmaroute.ca

The website notifies you if an update is available. You can then select to download the update.

You will need an empty USB drive. Please check the website for minimum requirements. Once you have inserted the USB drive into your computer, choose to start the download. Follow the instructions provided to download the files to the USB drive.

The installation of most files occurs in the background, and does not interrupt your use of the system. Navigation updates cannot be installed in the background, because the files are too large.

To install the update in your vehicle, remove anything that is plugged in the USB ports on the media hub and plug in the USB drive containing the update. When the USB drive is plugged in, the installation should begin immediately. After a successful installation, the update is available the next time the vehicle is started.

Please refer to the website for any further actions.

Updating Over Wi-Fi

To update your System over Wi-Fi your vehicle must be within the range of a Wi-Fi access point. Data rates may apply.

To connect your system to Wi-Fi, select:

Menu Item	
Settings	
Wi-Fi	
Available Wi-Fi Networks	You can then select your Wi-Fi network. You may have to enter the security code if the network is secured. The system confirms when it has connected to the network.

You must also give the system permission to update automatically. Upon vehicle delivery, the System asks you if you would like to use the automatic update feature. If you agree to automatic updates, you can press OK to confirm. If this selection does not appear upon vehicle delivery you can access it through the General Settings. See **Settings** (page 393). You can also perform a master reset. See **SYNC™ 3 Troubleshooting** (page 405).

If you would like to switch this feature on later, select:

Menu Item	
Settings	
General	
Automatic System Updates	From this menu, you can enable automatic updates. If you have not done so already, the system prompts you to set up a Wi-Fi connection when you enable this feature.

When Wi-Fi and automatic updates are enabled, your system checks for software updates periodically. If a new version is available, it downloads at that time. Software downloads can take place for up to 30 minutes after you have switched your vehicle off. The updates do not interrupt the normal use of your SYNC 3 system. If a download does not complete for any reason, the download continues where it left off at the next Wi-Fi connected opportunity. Upon activation of an update, a banner displays on the touchscreen indicating the system update. Select the icon to see more detail. This icon displays for two ignition cycles.

To switch this feature off:

Menu Item	
Settings	
General	
Automatic System Updates	In this menu selection, you can change the selection for automatic updates to OFF.

Support

The SYNC support team is available to help you with any questions you are not able to answer on your own.

Monday-Saturday, 8:30am-8:00pm EST.

For Ford:

United States: 1-800-392-3673.

Canada: 1-800-565-3673.

Times are subject to change due to holidays.

Privacy Information

When you connect a cellular phone to SYNC 3, the system creates a profile within your vehicle that links to that cellular phone. This profile helps in offering you more cellular features and operating more efficiently. Among other things, this profile may contain data about your cellular phone book, text messages (read and unread), and call history, including history of calls when your cell phone was not connected to the system. In addition, if you connect a media device, the system creates and retains an index of supported media content. The system also records a short diagnostic log of approximately 10 minutes of all recent system activity. The log profile and other system data may be used to improve the system and help diagnose any problems that may occur.

The cellular profile, media device index, and diagnostic log remain in your vehicle unless you delete them and are generally accessible only in your vehicle when the cellular phone or media player is connected.

If you no longer plan to use the system or your vehicle, we recommend you perform a Master Reset to erase all stored information. You can find more information about the Master Reset in General Settings. See **Settings** (page 393). System data cannot be accessed without special equipment and access to your vehicle's SYNC 3 module. Ford Motor Company and Ford of Canada do not access the system data for any purpose other than as described absent consent, a court order, or where required by law enforcement, other government authorities, or other third parties acting with lawful authority. Other parties may seek to access the information independently of Ford Motor Company and Ford of Canada.

HOME SCREEN



E205446

Item	Title	Home screen display
A	Audio	Shows the active media source. If your vehicle does not have navigation, this space contains the compass.
B	Phone	The name of the connected phone appears on the screen. The status of the phone features also appear. This includes signal strength, battery charge, 911 assist setting state (On or Off), text messaging and roaming.
C	Navigation ¹	This map displays your current location or current route in real time. When you have navigation active, you also see the next turn and the length of time and distance to your destination.

SYNC™ 3 (If Equipped)

Item	Title	Home screen display
		If your vehicle does not have navigation, this space contains the audio information.

¹ If equipped.

You can touch any of the feature displays to access that feature.

Anytime you select the home button, the system returns you to this screen.

USING VOICE RECOGNITION

The SYNC 3 system allows you to use voice commands, to control features like audio and climate controls. By using voice commands, you can keep your hands on the wheel and your eyes on the road.

You can access each feature controlled by SYNC 3 through a variety of commands.



To activate the SYNC 3 voice commands push the voice button on the steering wheel and wait for the prompt.

___ is a dynamic listing, meaning that it can be the name of anything, such as artist, the name of contact or number. The context and the description of the command tell you what to say for this dynamic option.

There are some commands that work for every feature, these commands are:

Voice Command	Action and Description
Main Menu	Brings you to the main menu.
Go back	Returns you to the previous screen.
Cancel	Ends the voice session.
List of Commands	Gives you a list of possible voice commands.
___ List of Commands	You can name any feature and the system gives a list of commands available for the feature. For example, you could say:
	Phone List of Commands
	Navigation List of Commands
Next Page	You can use this command to view the next page of options on any screen where multiple pages of choices are given.
Previous Page	You can use this command to view the previous page of options on any screen where multiple pages of choices are given.
Help	Gives you available commands you can use on the current screen.

SYNC™ 3 (If Equipped)

Included here are some of the most popular commands for each SYNC 3 feature.

Audio Voice Commands

___ is a dynamic listing, meaning that for audio voice commands it can be the name of a Sirius channel or a channel number, a radio frequency number, or the name of an artist, album, song or a genre.

To control the media features, press the voice button and when prompted, say:

Voice command	Description
Sirius Channel ___ ¹	You can say the Sirius channel name or number such as "Sirius channel 16".
You can also turn to a Sirius channel by saying the channel's name, such as "The Pulse".	
AM ___ FM ___	Allows you to tune to a specific FM or AM frequency such as "88.7 FM" or "1580 AM".
FM ___ HD ___ ¹	Allows you to tune to a specific HD frequency such as "88.7 FM HD 1".
Bluetooth Audio	Allows you to listen to music on your Bluetooth-connected device.
USB	Allows you to listen to music on your USB connected device.
Play Genre ___ Play Playlist ___ Play Artist ___ Play Album ___ Play Podcast ___ Play Song ___ Play Audiobook ___	For USB audio only, you can say the name of an artist, album, song or a genre to listen to that selection. Your system must finish indexing before this option is available. For example, you could say "Play artist, The Beatles" or "Play song, Penny Lane".
Browse ___	For USB audio only, you can say the name of an artist, album, or a genre to browse by that selection. Your system must finish indexing before this option is available. For example you can say "Browse The Beatles" or "Browse folk".

¹ This option may not be available in all markets or may require a subscription.

SYNC™ 3 (If Equipped)

Climate Voice Commands

You can control the temperature of the vehicle using voice commands.

___ is a dynamic listing, meaning that for climate voice commands it can be the desired degrees for the temperature setting.

To adjust the temperature, say:

Voice command	Description
Climate Set Temperature ___	Adjust the temperature between 60–85°F (15.5–29.5°C).
Climate Help	

Phone Voice Commands

Pairing a Phone

You can use voice commands to connect your Bluetooth-enabled phone to the system.

To pair your phone, press the voice button and when prompted, say:

Voice command	Description
Pair Phone	Follow the on-screen instructions to complete the pairing process. See Settings (page 393).

Making Calls

___ is a dynamic listing, meaning that for phone voice commands it can be the name of the contact you wish to call or the digits you want to dial.

Press the voice button and say a command similar to the following:

Voice command	Description
Call ___	Allows you to call a specific contact from your phonebook such as "Call Jenny".
Call ___ at ___	Allows you to call a specific contact from your phonebook at a specific location such as "Call Jenny at Home".
Dial ___	Allows you to dial a specific number such as "Dial 867-5309".

SYNC™ 3 (If Equipped)

Please make sure that you are saying the contact name exactly as it appears in your contact list.

Once you have provided the digits of the phone number, you can say the following commands:

Voice Command	Description
<0-9>	If the full number was not entered with the first command, you can continue saying the number.
Dial	Tells SYNC 3 to make the phone call.
Delete	Tells SYNC 3 to erase the last block of digits stated.
Clear	Tells SYNC 3 to erase the entire number.

Text Message Voice Commands

To access text message options, press the voice button and say:

Voice command	Description
Listen to Message	
Listen to text message ____	You can say the number of the message you would like to hear.
Reply to Message	

Navigation Voice Commands (If Equipped)

____ is a dynamic listing, meaning that for navigation voice commands it can be a POI category or an address.

Setting a Destination

You can use any of the following commands to set a destination or find a point of interest.

You can find an address, a point of interest (POI), or search for points of interest by category:

Voice command	Description
Find an Address	Allows you to enter the address search functionality.
Find a ____	State the name of the POI category you would like to search for such as "Find restaurants".
Find POI	Allows you to enter the POI search functionality.

SYNC™ 3 (If Equipped)

Voice command	Description
Find Intersection	Allows you to enter the intersection search functionality.
Destination Nearest —	State the name of the POI category you would like to search for nearby such as "Destination nearest restaurants".
Destination Previous Destination	Allows you to see a list of your previous destinations.
Destination Home	Allows you to route to your home address.

In addition, you can say these commands when a route is active:

Voice command	Description
Cancel Route	Cancels the current route.
Detour	Allows you to select an alternate route.
Repeat Instruction	Repeats the last guidance prompt.
Show Route	Displays the active route.
Where Am I	Provides current location.
Zoom in	Allows you to zoom in on the map.
Zoom out	Allows you to zoom out from the map.

Mobile App Voice Commands (If Equipped)

The following voice commands are always available:

Voice command	Description
Mobile Apps	SYNC 3 will prompt you to say the name of an app to start it on SYNC 3.
List Mobile Apps	SYNC 3 will list all of the currently available Mobile Apps.
Find New Apps	SYNC 3 will search and connect to compatible app(s) running on your mobile device.

SYNC™ 3 (If Equipped)

There are also voice commands that you can use when app(s) are connected to SYNC 3:

Voice command	Description
Say the name of an app	At any time, you can say the name of a mobile app to start the mobile app on SYNC 3.
Say the name of an app, followed by help	SYNC 3 will list the available voice commands for the specified app if the app is running on SYNC 3.

SiriusXM Traffic and Travel Link Voice Commands (If Equipped)

SiriusXM Traffic and Travel Link may not be available in all markets. Activation and a subscription are required.

You can say the following commands to access SiriusXM Traffic and Travel Link:

Voice command	Description
Show Traffic	Displays a list of traffic incidents.
Show Weather Map	Displays the current weather map.
Show Fuel Prices	Displays a list of fuel prices.
Show 5 Day Forecast	Displays the 5 day weather forecast.
Help	

Voice Settings Commands

You can say the following commands to access the voice settings:

Voice command	Description
Voice Settings	Allows you to enter the voice settings functionality.
Interaction Mode Standard	Sets standard prompting with longer prompts.
Interaction Mode Advanced	Sets advanced prompting with shorter prompts.
Phone Confirmation On	Allows the system to confirm before making a phone call.

SYNC™ 3 (If Equipped)

Voice command	Description
Phone Confirmation Off	The system does not confirm before placing a call.
Voice Command Lists On	The system displays a short list of available commands.
Voice Command Lists Off	The system does not display the list of commands.

You can use the volume control to adjust the volume of the system voice prompts. While prompt is active, adjust the volume control up or down to your desired setting.

Note: Depending on the current climate control settings, the fan speed may automatically go down while issuing voice commands or while making and receiving phone calls via SYNC to reduce the amount of background noise in the vehicle. The fan speed will automatically return to normal operation once the voice session ends. Fan speed can also be adjusted normally during a voice session, simply press fan buttons (or turn fan knob) to increase or decrease fan speed to desired setting.

To disable this automatic fan speed reduction feature during voice sessions, press and hold the climate control AC and Recirculated air buttons simultaneously, release and then increase fan speed within 2 seconds. To re-enable this feature, repeat the above sequence.

ENTERTAINMENT



E205443

Message	Message and description
A	Sources
B	Direct Tune
C	Presets

You can access these options using the touchscreen or voice commands.

Sources

Press this button to select the source of media you want to listen to.

SYNC™ 3 (If Equipped)

Menu item	
AM	
FM	
SIRIUS ¹	
CD ¹	
USB	The name of the USB that is plugged in displays here.
Bluetooth Stereo	
Apps	If you have SYNC 3 compatible apps on your connected smart phone, they display here as individual source selections.

¹ This feature may not be available in all markets and requires an active subscription.

AM/FM Radio

Tuning a Station

You can use the tune or seek controls on the radio bezel to select a station.

To tune a station using the touchscreen, select:

Menu item
Direct Tune

A pop up appears, allowing you to type in the frequency of a station. You can only enter a valid station for the source you are currently listening to.

You can press the backspace button to delete the previously entered number.

Once you have entered the station's call numbers, you can select:

Menu item	Action and description
Enter	Press to begin playing the station you have entered.
Cancel	Press to exit without changing the station.

Presets

To set a new preset, tune to the station and then press and hold one of the memory preset buttons. The audio mutes briefly while the system saves the station and then returns.

There are two preset banks available for AM and three banks for FM. To access additional presets, tap the preset button. The indicator on the preset button shows which bank of presets you are currently viewing.

SYNCTM 3 (If Equipped)

SIRIUS® Satellite Radio (If Activated)

Note: This feature may not be available in all markets and requires an active subscription.



E234451

SIRIUS satellite radio is a subscription-based satellite radio service that broadcasts a variety of music, sports, news, weather, traffic and entertainment programming. Your factory-installed SIRIUS satellite radio system includes hardware and a limited subscription term that begins on the date of sale or lease of your vehicle. See an authorized dealer for availability.

For more information on extended subscription terms (a service fee is required), the online media player and a list of SIRIUS satellite radio channels, and other features, please visit www.siriusxm.com in the United States, www.siriusxm.ca in Canada, or call SIRIUS at 1-888-539-7474.

Note: SIRIUS reserves the unrestricted right to change, rearrange, add or delete programming. This includes canceling, moving or adding particular channels, and its prices, at any time, with or without notice to you. Ford Motor Company shall not be responsible for any such programming changes.

Note: This receiver includes the eCos real-time operating system. eCos is published under the eCos License.

The following buttons are available for Sirius:

Menu item	Action and description	
Browse	Touch this button to see a list of available stations.	
Direct Tune	A pop-up appears, allowing you to type in the call numbers of a station. Once you enter the stations call numbers, you can select:	
	Enter	The system tunes to the station you select.
	Cancel	You exit the pop-up and the current station continues to play.
	You can press the backspace button to delete the previous number.	

SYNC™ 3 (If Equipped)

Menu item	Action and description	
Replay	Replay audio on the current channel. You can replay approximately 45 minutes of audio as long as you remain tuned to the current station. Changing stations erases the previous audio.	
	Live	When you are in replay mode, you are not able to select a different preset until you return to live audio. Pressing this button returns you to the live broadcast.
ALERT	Save the current song, artist, or team as a favorite. The system alerts you when it plays again on any channel. Selecting this button allows you to enable and edit alerts. See Settings (page 393).	

Memory Presets

To set a preset, tune to the station then press and hold one of the memory preset buttons. The audio mutes briefly while the system saves the station and returns once the station is stored.

There are three preset banks available for SIRIUS. To access additional presets, tap the preset button. The indicator on the preset button shows which bank of presets you are currently viewing.

Satellite Radio Electronic Serial Number (ESN)

You need your ESN to activate, modify or track your satellite radio account. See **Settings** (page 393).

SIRIUS Satellite Radio Reception Factors and Troubleshooting

Potential reception issues	
Antenna obstructions	For optimal reception performance, keep the antenna clear of snow and ice build-up and keep luggage and other materials as far away from the antenna as possible.
Terrain	Hills, mountains, tall buildings, bridges, tunnels, freeway overpasses, parking garages, dense tree foliage and thunderstorms can interfere with your reception.
Station overload	When you pass a ground-based broadcast-repeating tower, a stronger signal may overtake a weaker one and the audio system may mute.
Satellite radio signal interference	Your display may show ACQUIRING... to indicate the interference and the audio system may mute.

SYNCTM 3 (If Equipped)

Troubleshooting tips		
Message	Cause	Action
Acquiring Signal	Radio requires more than two seconds to produce audio for the selected channel.	No action required. This message should disappear shortly.
Satellite antenna fault SIRIUS system failure	There is an internal module or system failure present.	If this message does not clear shortly, or with an ignition key cycle, your receiver may have a fault. See an authorized dealer for service.
Invalid Channel	The channel is no longer available.	Tune to another channel or choose another preset.
Unsubscribed Channel	Your subscription does not include this channel.	Contact SIRIUS at 1-888-539-7474 to subscribe to the channel, or tune to another channel.
Satellite acquiring signal...	The signal is lost from the SIRIUS satellite or SIRIUS tower to your vehicle antenna.	The signal is blocked. When you move into an open area, the signal should return.
Updating...	Update of channel programming in progress.	No action required. The process may take up to three minutes.
Questions? Call 1-888-539-7474	Your satellite service is no longer available.	Contact SIRIUS at 1-888-539-7474 to resolve subscription issues.
None found. Check channel guide.	All the channels in the selected category are either skipped or locked.	Use the channel guide to turn off the Lock or Skip function on that station.
SIRIUS Subscription updated	SIRIUS has updated the channels available for your vehicle.	No action required.

HD Radio™ Information (If Available)

Note: This feature may not be available in all markets.

To activate HD radio, please see the Radio Settings in the Settings Chapter. See **Settings** (page 393).

Note: HD Radio broadcasts are not available in all markets.

SYNC™ 3 (If Equipped)

HD Radio technology is the digital evolution of analog AM/FM radio. Your system has a special receiver that allows it to receive digital broadcasts (where available) in addition to the analog broadcasts, it already receives. Digital broadcasts provide a better sound quality than analog broadcasts with free, crystal-clear audio and no static or distortion. For more information, and a guide to available stations and programming, please visit:

Website
www.hdradio.com

When HD Radio is on and you tune to a station broadcasting HD Radio technology, you may notice the following indicators on your screen:



E142616

When HD Radio broadcasts are active, you can access the following functions:

Message	Action and description
Presets	Allows you to save an active channel as a memory preset. Touch and hold a memory preset slot until the sound returns. There is a brief mute while the radio saves the station. Sound returns when the channel saves. When switching to an HD2 or HD3 memory preset, the sound mutes before the digital audio plays, because the system has to reacquire the digital signal.

Note: As with any station you save, you cannot access the saved station if your vehicle is outside the station's reception area.

The HD logo is grey when acquiring a digital station, and then changes to orange when digital audio is playing. When this logo is available, you may also see Title and Artist fields on-screen.

The multicast indicator appears in FM mode (only) if the current station is broadcasting multiple digital broadcasts. The highlighted numbers signify available digital channels where new or different content is available. HD1 signifies the main programming status and is available in analog and digital broadcasts. Other multicast stations (HD2 through HD7) are only available digitally.

Note: There is also an additional feature for stations that have more than 1 HD multicast (For example, HD1 or HD2). The HD logo and Radio text appears as a button. Pressing this button allows you cycle through all of the HD stations on that specific frequency. For example, if you are on 101.1 and it has HD1, HD2, HD3, pressing the button repeatedly causes the radio to cycle through the HD stations in a cyclic increasing order.

SYNCTM 3 (If Equipped)

HD Radio Reception and Station Troubleshooting

Potential reception issues	
Reception area	<p>If you are listening to a multicast station and you are on the fringe of the reception area, the station may mute due to weak signal strength.</p> <p>If you are listening to HD1, the system changes back to the analog broadcast until the digital broadcast is available again. However, if you are listening to any of the possible HD2-HD7 multicast channels, the station mutes and stays muted unless it is able to connect to the digital signal again.</p>
Station blending	<p>When the system first receives a station (aside from HD2-HD7 multicast stations), it first plays the station in the analog version. Once the receiver verifies the station is an HD Radio station, it shifts to the digital version. Depending on the station quality, you may hear a slight sound change when the station changes from analog to digital. Blending is the shift from analog to digital sound or digital back to analog sound.</p>

In order to provide the best possible experience, use the contact form to report any station issues found while listening to a station broadcasting with HD Radio technology. Independent entities own and operate each station. These stations are responsible for ensuring all audio streams and data fields are accurate.

Potential station issues		
Issues	Cause	Action
Echo, stutter, skip or repeat in audio. Increase or decrease in audio volume.	This is poor time alignment by the radio broadcaster.	No action required. This is a broadcast issue.
Sound fading or blending in and out.	The radio is shifting between analog and digital audio.	No action required. The reception issue may clear up as you continue to drive.
There is an audio mute delay when selecting HD2 or HD3, multicast preset or Direct Tune.	The digital multicast is not available until the HD Radio broadcast is decoded. Once decoded, the audio is available.	No action required. This is normal behavior. Wait until the audio is available.

SYNC™ 3 (If Equipped)

Potential station issues		
Issues	Cause	Action
Cannot access HD2 or HD3 multicast channel when recalling a preset or from a direct tune.	The previously stored multicast preset or direct tune is not available in your current reception area.	No action required. The station is not available in your current location.
Text information does not match currently playing audio.	Data service issue by the radio broadcaster.	Fill out the station issue form. ¹
There is no text information shown for currently selected frequency.	Data service issue by the radio broadcaster.	Fill out the station issue form. ¹

¹ You can find the form here:

Website
http://www.ibiquity.com/automotive/report_radio_station_experiences

HD Radio Technology manufactured under license from iBiquity Digital Corp. U.S. and foreign patents. HD Radio and the HD and HD Radio logos are proprietary trademarks of iBiquity Digital Corp. Ford Motor Company and iBiquity Digital Corp. are not responsible for the content sent using HD Radio technology. Content may be changed, added or deleted at any time at the station owner's discretion.

CD (If equipped)

Once you select this option, the system returns you to the main audio screen.

The current audio information appears on the screen.

The following buttons are also available:

Button	Function
Browse	You can use the browse button to select a track.
Repeat	Select this button and a small number one displays to indicate the track is set to repeat.

SYNC™ 3 (If Equipped)

Button	Function
	For MP3 CDs, this button allows you to toggle through repeat off, repeat one track (a small number one displays), and repeat current folder (a small folder displays).
Shuffle	Select the shuffle symbol to have the audio on the disk play in random order.

You can use the forward, reverse, pause or play buttons to control the audio playback.

Bluetooth Stereo or USB

Bluetooth Stereo and USB allow you to access media that you store on your Bluetooth device or USB device such as music, audio books or podcasts.

The following buttons are available for Bluetooth and USB:

Button	Function
Repeat	Pressing the repeat button toggles the repeat setting through three modes: repeat off (button not highlighted), repeat all (button highlighted) and repeat track (button highlighted with a small number one).
Shuffle	Play the tracks in random order.

You can use the forward, reverse, pause or play buttons to control the audio playback.

To get more information about the currently playing track, press the cover art or Info button.

For some devices, SYNC 3 is able to provide 30-second skip buttons when you listen to audio books or podcasts. These buttons allow you to skip forward or backward within a track.

While playing audio from a USB device you can look for certain music by selecting the following:

Button	Function
Browse	If available, displays the list of tracks in the Now Playing playlist.
New Search	This option, which is available under browse, allows you to play all tracks or to filter the available media into one of the below categories.
	Play All

SYNC™ 3 (If Equipped)

Button	Function
	Playlists
	Artists
	Albums
	Songs
	Genres
	Podcasts
	Audio books
	Composers
A-Z Jump	This button allows you to choose a specific letter to view within the category you are browsing.
Explore Device	If available, this allows you to browse the folders and files on your USB device.

USB Ports

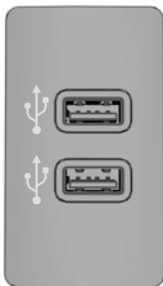

E211463

The USB ports are in the center console or behind a small access door in the instrument panel.

This feature allows you to plug in USB media devices, memory sticks, flash drives or thumb drives, and charge devices if they support this feature.

Select this option to play audio from your USB device.

Apps

The system supports the use of certain audio apps such as iHeartRadio through a USB or bluetooth-enabled device.

Each app gives you different on-screen options depending on the app's content. See **Apps** (page 390).

Supported Media Players, Formats and Metadata Information

The system is capable of hosting nearly any digital media player, including iPod, iPhone, and most USB drives.

Supported audio formats include MP3, WMA, WAV, AAC, and FLAC.

Supported audio file extensions include MP3, WMA, WAV, M4A, M4B, AAC, and FLAC.

SYNC™ 3 (If Equipped)

Supported USB file systems include: FAT, exFAT, and NTFS.

SYNC 3 is also able to organize the media from your USB device by metadata tags. Metadata tags, which are descriptive software identifiers embedded in the media files, provide information about the file.

If your indexed media files contain no information embedded in these metadata tags, SYNC 3 may classify the empty metadata tags as unknown.

SYNC 3 is capable of indexing up to 50,000 songs per USB device, for up to 10 devices.

CLIMATE

Touch the climate button on the touchscreen to access your climate control features. Depending on your vehicle line and option package, your climate screen may look different from one of the screens shown below. Your screen may not contain all of the features shown.

Note: You can switch temperature units between Fahrenheit and Celsius. See **Settings** (page 393).

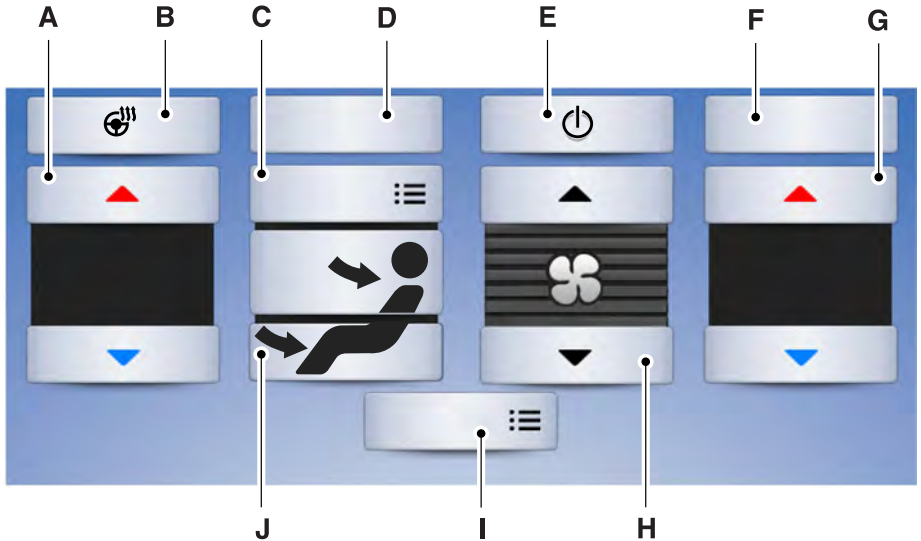

E224964

SYNC™ 3 (If Equipped)

Callout	Item	Description	
A	Left-hand front seat temperature:	Touch up or down to adjust the temperature.	
B	Heated steering wheel:	Touch the heated steering wheel icon to switch the heated steering wheel on and off (if equipped).	
C	Defrost	A pop up appears on the screen to display the defrost options.	
		MAX Defrost:	Touch the button to maximize defrosting. Outside air flows through the windshield vents, the fan automatically adjusts to the highest speed and the temperature dial returns to the full heat position. You can use this setting to defog or clear a thin covering of ice from the windshield. The heated rear window also automatically turns on when you select MAX Defrost.
		Defrost	Touch to clear the windshield of fog and thin ice. Touch again to return to the previous airflow selection. When on, defrost provides outside air to reduce window fogging and distributes air through the windshield defroster vents and demister vents. Note: To prevent window fogging, you cannot select recirculated air when Defrost is on.
D	AUTO	Touch the button to switch on automatic operation. Select the desired temperature using the temperature control. The system adjusts fan speed, air distribution, air conditioning operation, and selects outside air or recirculated air to heat or cool the vehicle in order to maintain the desired temperature.	
E	Power	Touch the button to switch the system on and off. Switching off the climate control system prevents outside air from entering the vehicle.	

SYNCTM 3 (If Equipped)

Callout	Item	Description	
F	DUAL	This button lights up when the passenger controls are active. To switch the dual zone operation off and link the passenger temperature to the driver temperature, touch the DUAL button to switch it off.	
G	Right-hand front seat temperature	Touch up or down to adjust the temperature.	
H	Fan speed:	Touch up or down to increase or decrease the volume of air circulated in your vehicle.	
I	A/C	MAX A/C	Touch to cool your vehicle with recirculated air. Touch again for normal A/C operation. MAX A/C distributes air through instrument panel vents and may help reduce odors from entering your vehicle. MAX A/C is more economical and efficient than normal A/C mode.
		A/C	Touch to switch the air conditioning on or off. Use A/C with recirculated air to improve cooling performance and efficiency. A/C engages automatically in MAX A/C, defrost and footwell/defrost
		Recirculated air:	Touch to switch the recirculated air on or off which may reduce the amount of time needed to cool down the interior and help reduce odors from reaching the interior. Recirculated air also engages automatically when you select MAX A/C. You can engage this manually in any airflow mode except defrost. It may also turn off in all airflow modes except MAX A/C to reduce fog potential.

SYNC™ 3 (If Equipped)

Callout	Item	Description
J	Manual airflow distribution controls:	Select these controls individually, together or with Defrost to direct the air flow to the area you desire.
	Panel:	Distributes air through the instrument panel vents.
	Floor:	Distributes air through the demister vents, floor vents and rear seat floor vents.

PHONE

WARNING



Driving while distracted can result in loss of vehicle control, crash and injury. We strongly recommend that you use extreme caution when using any device that may take your focus off the road. Your primary responsibility is the safe operation of your vehicle. We recommend against the use of any hand-held device while driving and encourage the use of voice-operated systems when possible. Make sure you are aware of all applicable local laws that may affect the use of electronic devices while driving.

Hands-free calling is one of the main features of the system. Once you pair your cell phone, you can access many options using the touchscreen or voice commands. While the system supports a variety of features, many are dependent on your cell phone's functionality.

Pairing Your Cell Phone for the First Time

Pair your Bluetooth-enabled phone with the system before using the functions in hands-free mode.

Switch on Bluetooth on your device to begin pairing. See your phone's manual if necessary.

To add a phone, select:

Menu Item
Add Phone

1. Follow the on-screen instructions.
2. A prompt alerts you to search for the system on your phone.
3. Select your vehicle's make and model as it displays on your phone.

4. Confirm that the six-digit number appearing on your phone matches the six-digit number on the touchscreen.
5. The touchscreen indicates when the pairing is successful.
6. Your phone may prompt you to give the system permission to access information. To check your phone's compatibility, see your phone's manual or visit the website.

Alternatively, to add a phone, select:

Menu Item
Add Phone
Then select:
Discover Other Bluetooth Devices

1. Follow the on-screen instructions.
2. Select your phone's name when it appears on the touchscreen.
3. Confirm that the six-digit number appearing on your phone matches the six-digit number on the touchscreen.
4. The touchscreen indicates when the pairing is successful.
5. Your phone may prompt you to give the system permission to access information. To check your phone's compatibility, see your phone's manual or visit the website.

At a minimum, most cell phones with Bluetooth wireless technology support the following functions:

- Answering an incoming call.
- Ending a call.
- Dialing a number.
- Call waiting notification.
- Caller identification.

SYNC™ 3 (If Equipped)

Other features, such as text messaging using Bluetooth and automatic phonebook download, are phone-dependent features.

To check your phone's compatibility, see your phone's manual or visit the website:

Websites
owner.ford.com

Websites

www.syncmyride.ca
www.syncmaroute.ca

Phone Menu

This menu becomes available after pairing a phone.

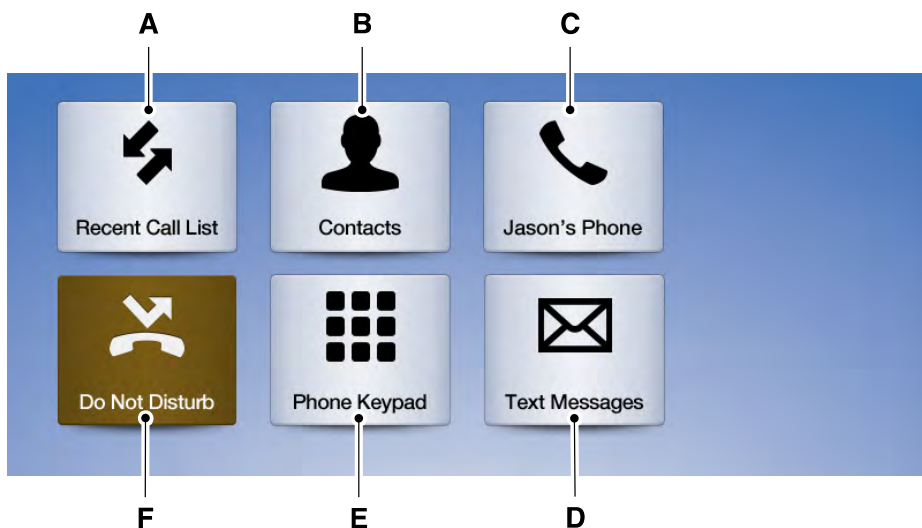

E205447

Item	Menu Item	Action and Description
A	Recent Call List	Displays your recent calls. You can place a call by selecting an entry from this list.

SYNC™ 3 (If Equipped)

Item	Menu Item	Action and Description			
		You can also sort the calls by selecting the drop down menu at the top of the screen. You can choose:			
		All	Incoming	Outgoing	Missed
B	Contacts	All of your contacts from your phone display in alphabetical order.			
		A-Z Jump		Selecting this button allows you to choose a specific letter to view.	
C	Phone Settings	Displays the name of your phone and takes you to the phone settings options. From this menu, you can pair subsequent devices, set ring tones and alerts. See Settings (page 393).			
D	Text Messages	Displays all recent text messages.			
E	Phone Keypad	Use this keypad to dial in a phone number. Use the backspace button to delete numbers.			
		Call		Press this button to begin a call.	
F	Do Not Disturb	Touch this button to send all calls directly to your voicemail. New text message notifications are not displayed on the screen and all ringtones and alerts are set to silent.			

Users with phones having voice services may see a button to access the feature. For example, iPhone users see a Siri button. A press and hold of the voice button on the steering wheel also accesses this feature.

Making Calls

There are many ways to make calls from the SYNC 3 system, including using voice commands. See **Using Voice Recognition** (page 356). You can use the touchscreen to place calls as well.

To call a number in your contacts, select:

Menu Item	Action and Description
Contacts	You can then select the name of the contact you want to call. Any numbers stored for that contact display along with any stored contact photos. You can then select the number that you want to call. The system begins the call.

To call a number from your recent calls, select:

Menu Item	Action and Description
Recent Call List	You can then select an entry that you want to call. The system begins the call.

To call a number that is not stored in your phone, select:

Menu Item	Action and Description
Phone Keypad	Select the digits of the number you wish to call.
Call	The system begins the call.

Pressing the backspace button deletes the last digit you typed.

Receiving Calls

During an incoming call, an audible tone sounds. Caller information appears in the display if it is available.

To accept the call, select:

Menu Item
Accept

Note: You can also accept the call by pressing the phone button on the steering wheel.

To reject the call, select:

Menu Item
Reject

Note: You can also reject the call by pressing the phone button on the steering wheel.

Ignore the call by doing nothing. SYNC 3 logs it as a missed call.

During a Phone Call

During a phone call, the contacts name and number display on the screen along with the call duration.

The phone status items are also visible:

- Signal Strength.
- Battery.
- 911 Assist (United States and Canada only). See **Settings** (page 393).

You can select any of the following during an active phone call:

SYNC™ 3 (If Equipped)

Item	
End Call	Immediately end a phone call. You can also press the button on the steering wheel.
Keypad	Press this to access the phone keypad.
Mute	You can switch the microphone off so the caller does not hear you.

Item	
Privacy	Transfer the call to the cell phone or back to SYNC 3.

Text Messaging

Note: Downloading and sending text messages using Bluetooth are cell phone-dependent features.

Note: Certain features in text messaging are speed-dependent and not available when your vehicle is traveling at speeds over 3 mph (5 km/h).

Receiving a Text Message

When a new message arrives, an audible tone sounds and the screen displays a pop-up with the caller name and ID, if supported by your cell phone. You can select:

Menu Item	Action and Description
Hear It	Have SYNC 3 read the message to you.
View	View the text on the touchscreen.
Call	To call the sender.
Reply	You can select from 15 preset messages. Press the message that you would like to use and confirm to send the message. SYNC 3 confirms when the message is sent successfully.
Close	To exit the screen.

Smartphone Connectivity (If Equipped)

SYNC 3 allows you to use Apple CarPlay and Android Auto to access your phone.

When you use Apple CarPlay or Android Auto, you can:

- Make calls.
- Send and receive messages.
- Listen to music.
- Use your phone's voice assistant.

Apple CarPlay and Android Auto disable some SYNC 3 features.

Most Apple CarPlay and Android Auto features use mobile data.

Apple CarPlay

Apple CarPlay requires an iPhone 5 or newer with iOS 7.1 or newer. Updating to the latest iOS version is recommended.

1. Plug your phone into a USB port. See **USB Port** (page 305).

SYNC™ 3 (If Equipped)

2. Select Apple CarPlay on the touchscreen.

To disable this feature from the Settings screen, select:

Menu Item
Apple CarPlay Preferences
Your device is listed if SYNC detects Apple CarPlay. Select the name of your device and select:
Disable

To return to SYNC 3, go to the Apple CarPlay home screen and select the SYNC app.

Note: Contact Apple for Apple CarPlay support.

Android Auto

Android Auto is compatible with most devices with Android 5.0 or newer.

1. Download the Android Auto app to your device from Google Play to prepare your device (this may require mobile data usage).

Note: The Android Auto App may not be available within your current market.

2. To switch this feature on from the Settings screen, scroll left on the screen and select:

Menu Item
Android Auto Preferences
Enable Android Auto

Note: Android Auto must be switched on prior to plugging your device.

You can then plug your device into a USB port. See **USB Port** (page 305).

To disable this feature from the Settings screen, select:

Menu Item
Android Auto Preferences
Your device is listed if SYNC detects Android Auto. Select the name of your device and select:
Disable

Note: You may need to slide your Settings screen to the left to select **Apple CarPlay Preferences** or **Android Auto Preferences**.

To return to SYNC 3, select the speedometer icon in the Android Auto menu bar at the bottom of the touchscreen, and then touch the option to return to SYNC.

Note: Contact Google for Android Auto support.

NAVIGATION

Your navigation system is comprised of two main features, destination mode and map mode.

Map Mode

Map mode shows advanced viewing comprised of 2D city maps, 3D landmarks and 3D city models (when available). 2D city maps show detailed outlines of buildings, visible land use, landscape features, and detailed railroad infrastructure for the most essential cities around the globe.

3D landmarks appear as clear, visible objects that are typically recognizable and have a certain tourism value.

SYNCTM 3 (If Equipped)

3D city models are complete 3D models of entire city areas including navigable roads, parks, rivers and rendered buildings. 3D landmarks and city models appear in 3D map mode only. Coverage of these varies and improves with updated map releases.



Select the zoom in icon to see a closer view of the map.



Select the zoom out icon to see a farther away view of the map.

You can adjust the view in preset increments. You can also pinch to zoom in or out of the map.

The information bar tells you the names of streets, cities or landmarks as you hover over them with the crosshair cursor.

You can change your view of the map by tapping on the location indicator icon on the right hand side of the screen. You can choose from the following options:



Heading up (2D map) This always shows the direction of forward travel to be upward on the screen. This view is available for map scales up to 3 mi (5 km).

N



North up (2D map) always shows the northern direction to be upward on the screen.

3D



3D map mode provides an elevated perspective of the map. Adjust this viewing angle and rotate the map 180 degrees by touching the map twice, and

then dragging your finger along the shaded bar with arrows at the bottom of the map.



Re-center the map by pressing this icon whenever you scroll the map away from your vehicle's current location.



Points of Interest (POI)

grouping icon: You can choose up to three POI icons to display on the map. If the chosen POIs are located close together or are

at the same location a box is used to display a single category icon instead of repeating the same icon, in order to reduce clutter. When you select the box on the map, a pop-up appears indicating how many POIs are in this location. Select the pop up to see a list of the available POIs. You can scroll through and select POIs from this list.

If your vehicle is low on charge or fuel, station icons automatically display on the map.

If you have subscribed to SiriusXM Traffic and Travel Link (where available), traffic flow will be indicated on the map by green (clear), yellow (slowing), and red (stopped) road highlights. Traffic flow is indicated where the information is available and varies across the US.

You can choose to display traffic icons on the map representing twelve different types of incidents. See **Settings** (page 393).

You can set a destination by hovering above a location and selecting:

Button
Start

SYNC™ 3 (If Equipped)

Destination Mode

To set a destination, press:

Menu Item	Description
Destination	
Enter a navigation destination in any of the following formats:	
Search	Street Address (number, street, city, state) For example "12 Mainstreet Dearborn MI"
	Partial Address (number, street) if searching in current state (number, street and zip code (or postal code in Canada)) if searching out of state You can enter unique addresses that contain door number prefixes with or without the prefix. For example, you could enter "6N340 Fairway Lane" or "340 Fairway Lane".
	City (name or zip code)
	Point of Interest (name or category)
	Intersection (street 1 / street 2) (street 1 and street 2) (street 1 & street 2) (street 1 @ street 2) (street 1 at street 2)
	Latitude and Longitude (##.##### , ##.#####) This is in a decimal degrees format, one to six decimal places are accepted.
	You are given autocomplete options below the address bar to select as you type. If you do not give an exact destination, a menu displays with your possible selections.
Previous Destinations	Collections of your last 40 navigation destinations display here. You can select any option from the list to select it as your destination.

SYNCTM 3 (If Equipped)

Menu Item	Description	
	Delete All	Select this option to remove all previous destinations.
Home	Select to navigate to your set Home destination. The time it takes to travel from your current location to Home displays. To set your Home, press:	
	Home	A prompt appears asking if you would like to create a favorite for home. Select:
	Yes	Enter a location into the search bar and press:
	Save	
Work	Select to navigate to your set Work destination. The time it takes to travel from your current location to Work displays. To set your Work:	
	Work	A prompt appears asking if you would like to create a favorite for work. Select:
	Yes	Enter a location into the search bar and press:
	Save	
Favorites	Favorites include any location you have previously saved. To add Favorites:	
	Add a Favorite	Select this button and enter a location into the destination bar.
	Search	Select this option to have the system locate the address you have entered.
	Save	Select this button when the address you have entered appears on the screen.
	The address saves as a favorite and you see the favorites screen. You can now select this address from the favorites screen.	
Point of Interest (POI) Categories	POI categories that may display (based on market and vehicle configuration):	
	Food	
	Fuel	
	Hotel	
	ATM	

SYNC™ 3 (If Equipped)

Menu Item	Description	
	See All	Press to view additional categories. Once you have selected a category, follow the menus to find what you are looking for.
	Inside of these categories you can search by:	
	Nearby	
	Along Route	
	Near Destination	
	In a City	

Once you have chosen your destination, press:

Menu Item	Action and Description	
Save	This saves the destination to your favorites.	
Start	This shows you a map of your entire route. You can then choose your route from three different options.	
	Fastest	Uses the fastest moving roads possible.
	Shortest	Uses the shortest distance possible.
	Economical Route	Uses the most fuel-efficient route.
	The time and distance for each route also displays.	
Cancel	On the route screen, you can choose to cancel the current navigation. The system asks for confirmation then returns you to the map mode screen.	

Once you have chosen your destination, press:

Menu Item	Action and Description
Start	The system uses a variety of screens and prompts to guide you to your destination. During Route guidance, you can press the maneuver arrow icon on the map if you want the system to repeat route guidance instructions. When the system repeats the last guidance instruction, it updates the distance to the next guidance instruction, since it detects that the vehicle is moving.

SYNC™ 3 (If Equipped)

Menu Item	Action and Description
	The navigation map shows your estimated time of arrival, remaining travel time and the distance to your destination. SYNC 3 may not always announce vehicle arrival at the exact point of your destination and you may have to cancel a route manually.

Navigation Menu

In map mode and during active navigation you can access the navigation menu.

During active navigation, touch the bottom of the screen to view the menu and other buttons.

To access the Navigation menu, press:

Button		
Menu		
You can then select:		
Screen View	Full Map	A full screen map displays during navigation.
	Highway Exit Info	Highway exit information displays on the right hand side of the screen during navigation. Points of interest icons display for restaurants, hotels, fuel stations and ATMs when they are present at the exit. You can select the POI icons to receive a listing of specific locations. You can select the POI location as a waypoint or destination if desired.
	Turn List	Only available during an active route. Displays all of the turns on the current route. You can choose to avoid any road on the turn list by selecting the road from the list. A screen then appears and you can press:
		Avoid
Traffic List	You can find the SiriusXM Traffic and Travel Link information by pressing this button. This information requires an active subscription to SiriusXM Traffic and Travel Link. When a route is not active, a list of nearby traffic incidents displays (if any are present). When a route is active, you can choose to display a list of traffic nearby or on the route.	

SYNC™ 3 (If Equipped)

Button		
Navigation Settings	Press this button to adjust your preferences. See Settings (page 393).	
Where Am I?	Provides your current location city and the nearest road.	
The following are only available on the menu during an active navigation route:		
Cancel Route	The system asks for confirmation and then returns you to the map mode screen.	
Mute Guidance	Selecting this option switches off the audio navigation guidance. Press the button again to un-mute guidance.	
View Route	Press this to see a map of the full route.	
Detour	An alternate route displays in comparison with the current route.	
Edit Waypoints	Only available if you have an active waypoint on your route. See Waypoints later in this section for information on how to set waypoints.	
	Use this button to re-order or remove your waypoints.	
	You can also have the system set the order for you by pressing:	Optimize Order
	To return to your route press:	Go

Waypoints

You can add a waypoint to a navigation route as a destination along your route.

To add a waypoint:

1. Select the search icon (magnifying glass) while on an active route. This brings up the destination menu.
2. Set your destination using any of the given methods. Once the destination has been selected, the screen allows you to set the destination as a waypoint by selecting:

SYNCTM 3 (If Equipped)

Menu Item	
Add Waypoint	The waypoint list then appears and you are able to re-order all of your waypoints by selecting the menu icon on the right hand side of the location. You can select up to five waypoints.
You can also have the system set the order for you by pressing:	Optimize Order
To return to your route, press:	Go

cityseeker (If Equipped)

Note: *cityseeker point of interest (POI) information is limited to approximately 1,110 cities (1,049 in the United States, 36 in Canada and 15 in Mexico).*



E225487

cityseeker, when available, is a service that provides more information about certain points of interest such as restaurants, hotels and attractions.

When you have selected a point of interest, the location and information appear, such as address, phone number and a star rating.

Press **More Information** to see a photo, a review, a list of services and facilities, the average room or meal price and the web address. This screen displays the point of interest icons.

For restaurants, cityseeker can provide information such as star rating, average cost, review, handicap access, hours of operation, and website address.

For hotels, cityseeker can provide information such as star rating, price category, review, check-in and checkout times, hotel service icons and website address. Hotel service icons include:

- Restaurant
- Business center
- Handicap facilities
- Laundry
- Refrigerator
- 24 hour room service
- Fitness center
- Internet access
- Pool
- Wi-Fi

Attractions include nearby landmarks, amusement parks, historic buildings and more. cityseeker can provide information such as star rating, reviews, hour of operation and admission price.

SYNC™ 3 (If Equipped)

SiriusXM Traffic and Travel Link

SiriusXM Traffic and Travel Link is available on vehicles equipped with navigation and only in select markets. You must activate and subscribe to receive SiriusXM Traffic and Travel Link information. It helps you locate the best gas prices, find movie listings, get current traffic alerts, view the weather map, get accurate ski conditions and see current sports scores. See **Apps** (page 390).

The system calculates a reasonable efficient route based on available speed limits, traffic, and road conditions. You may know a local short cut that is more efficient at a given time than the route provided by SYNC 3, but you should expect a slight difference in minutes or miles with the SYNC 3 route.

Navigation Map Updates

Annual navigation map updates are available for purchase through your dealership, by calling 1-866-462-8837 in the United States and Canada or 01-800-557-5539 in Mexico. You can also visit:

Website
www.navigation.com/sync

You need to specify the make and model of your vehicle to determine if there is an update available.

HERE is the digital map provider for the navigation application. If you find map data errors, you may report them directly to HERE by going to www.here.com/mapcreator. HERE evaluates all reported map errors and responds with the result of their investigation by e-mail.

Map coverage includes the USA (including Puerto Rico and the US Virgin Islands), Canada and Mexico.

APPS

The system enables voice, steering wheel, and touch screen control of SYNC 3 AppLink enabled smartphone apps.

Once an app is running through AppLink, you can control main features of the app through voice commands and steering wheel controls.

Note: Available AppLink enabled apps will vary by market.

Note: You must pair and connect your smartphone via Bluetooth to SYNC 3 to access AppLink.

Note: iPhone users need to connect the phone to the USB port.

Note: For information on available apps, supported smartphone devices and troubleshooting tips please visit:

Websites
owner.ford.com www.syncmyride.ca www.syncmaroute.ca

Note: Make sure you have an active account for the app that you have downloaded. Some apps will work automatically with no setup. Other apps will want you to configure your personal settings and personalize your experience by creating stations or favorites. We recommend you do this at home or outside of your vehicle.

Note: We encourage you to review the smartphone app's terms of service and privacy policies because Ford is not responsible for your app or its use of data.

SYNC™ 3 (If Equipped)

Note: AppLink is a native SYNC system feature. Accessing mobile apps through AppLink is only possible when Android Auto or Apple CarPlay are disabled. Some apps may only be accessible in the car through AppLink and others only through Android Auto or Apple CarPlay. Please refer to the Smartphone Connectivity information to disable Android Auto or Apple CarPlay.

Note: In order to use an app with SYNC 3, the app needs to be running in the background of your phone. If you shut down the app on your phone, it shuts down the app on SYNC 3 as well.

Note: If a SYNC 3 AppLink compatible app is not shown in the Apps Domain, make sure the required app is running on the mobile device.

Menu Item	Action and Description
Connect Mobile Apps	SYNC 3 will search and connect to compatible app(s) running on your mobile device.

Enabling SYNC 3 Mobile Apps

In order to enable mobile apps, SYNC 3 requires user consent to send and receive app authorization information and updates using the data plan associated with the connected device.

The connected device sends data to Ford in the United States. The information is encrypted and includes your VIN, SYNC 3 module number, odometer, usage statistics and debugging information. We retain this data for only as long as necessary to provide this service, troubleshoot, and improve products and services and to offer you products and services that may interest you where allowed by law.

Note: You must enable mobile apps for each connected device the first time you select a mobile app using the system.

Note: Ford reserves the right to limit functionality or deactivate mobile apps at any time.

Note: Standard data rates apply. Ford is not responsible for any additional charges you may receive from your service provider, when your vehicle sends or receives data through the connected device. This includes any additional charges incurred due to driving in areas when roaming out of a home network.

You can enable and disable apps through settings. See **Settings** (page 393).

App Permissions

The system organizes the aFpp permissions into groups. You can grant these group permissions individually. You can change a permission group status any time when not driving, by using the settings menu. While in the settings menu, you can also see the data included in each group.

When you launch an app using SYNC 3, the system may ask you to grant certain permissions, for example Vehicle information, Driving characteristics, GPS and Speed, and/or Push notifications. You can enable all groups or none of them during the initial app permissions prompts. The settings menu offers individual group permission control.

Note: You are only prompted to grant permissions the first time you use an app with SYNC 3.

Note: If you disable group permissions, apps will still be enabled to work with SYNC 3 unless you deactivate All Apps in the settings menu.

SYNC™ 3 (If Equipped)

SiriusXM Traffic and Travel Link (If Equipped)

WARNING



Driving while distracted can result in loss of vehicle control, crash and injury. We strongly recommend that you use extreme caution when using any device that may take your focus off the road. Your primary responsibility is the safe operation of your vehicle. We recommend against the use of any hand-held device while driving and encourage the use of voice-operated systems when possible. Make sure you are aware of all applicable local laws that may affect the use of electronic devices while driving.

Note: *SiriusXM Traffic and Travel Link may not be available in all markets.*

Note: *In order to use SiriusXM Traffic and Travel Link, your vehicle must have navigation.*

Note: *A paid subscription is required to access and use these features. Go to www.siriusxm.com/travellink for more information.*

Note: *Visit www.siriusxm.com/traffic and click on Coverage map and details for a complete listing of all traffic areas covered by SiriusXM Traffic and Travel Link.*

Note: *Neither Sirius nor Ford is responsible for any errors or inaccuracies in the SiriusXM Traffic and Travel Link services or its use in vehicles.*

When you subscribe to SiriusXM Traffic and Travel Link, it can help you locate the best gas prices, find movie listings, get current traffic alerts, view the current weather map, get accurate ski conditions and see scores to current sports games.

Menu Item	Action and Description	
Traffic on Route	Touch these buttons to identify traffic incidents on your route, near your vehicle's current location or near any of your favorite places, if programmed.	
Traffic Nearby		
Fuel Prices	Touch this button to view fuel prices at stations close to your vehicle's location or on an active navigation route.	
Movie Listings	Touch this button to view nearby movie theaters and their show times, if available.	
Weather	Touch this button to view the nearby weather, current weather, or the five-day forecast for the chosen area.	
	Map	Select to see the weather map, which can show storms, radar information, charts and winds.

SYNCTM 3 (If Equipped)

Menu Item	Action and Description	
	Area	Select to choose from a listing of weather locations.
Sports Info	Touch this button to view scores and schedules from a variety of sports. You can also save up to 10 favorite teams for easier access. The score automatically refreshes when a game is in progress.	
Ski Conditions	Touch this button to view ski conditions for a specific area.	

Sound

Pressing this button allows you to adjust the following:

SETTINGS

Under this menu, you can access and adjust the settings for many of the system features. To access additional settings, swipe the screen left or right.

Sound Settings	
Reset All	Returns Treble, Midrange, and Bass sound settings to factory levels.
Treble	Adjusts the high frequency level.
Midrange	Adjusts the middle frequency level.
Bass	Adjusts the low frequency level.
Balance / Fade	Adjusts the sound ratio from side to side or front to back.
Speed Compensated Vol.	Adjusts the amount the audio system volume increases with speed, or turns the feature off.
Occupancy Mode	Optimizes the sound based on the location of the listeners.
Sound Settings	Stereo
	Surround

Your vehicle might not have all of these features.

SYNC™ 3 (If Equipped)

Media Player

This button is available when a media device such as a Bluetooth Stereo or USB

device is the active audio source. Pressing the button allows you to access the following options for active devices only.

Menu Item	Action and Description		
Podcast Speed	For some Apple devices, SYNC 3 can adjust the playback speed of podcasts. When a podcast is playing, you can choose:		
	Slower	Normal	Faster
Audiobook Speed	For some Apple devices, SYNC 3 can adjust the playback speed of audiobooks. When an audiobook is playing, you can choose:		
	Slower	Normal	Faster
Cover Art Priority	Media Player	Cover art displays from your device's music files. If no cover art for the files exists on the device, then the Gracenote Database provides cover art.	
	Gracenote®	The Gracenote Database supplied cover art is used for your music files. This overrides any cover art from your device.	
Gracenote® Management	Switches on and off Gracenote® to provide metadata information such as genre, artist, album.		
Gracenote® Database Info	This allows you to view the version level of the Gracenote Database.		
Device Information	This allows you to view the manufacturer and model number of your media device.		
Update Media Index	Erase the stored in media information in order to re-index.		

Clock

To adjust the time, select the up and down arrows on either side of the screen. The arrows on the left adjust the hour and arrows on the right adjust the minute. You can then select AM or PM.

You can adjust the following features:

SYNCTM 3 (If Equipped)

Menu Item	Action and Description
Clock Format	Select how time displays.
Auto Time Zone Update	When active, the clock adjusts to time zone changes. This feature is only available in vehicles with navigation.
Reset Clock to GPS Time	When selected, the vehicle clock resets to GPS satellite time.

The system automatically saves any updates you make to the settings.

Bluetooth

Pressing this button allows you to access the following:

Menu Item	Action
Bluetooth	Turning Bluetooth off disconnects all devices and does not permit new connections.

You must activate Bluetooth to pair a Bluetooth-enabled device.

The processes of pairing a Bluetooth device is the same as pairing a phone. **See Pairing a Device** in Phone settings for how to pair a device and the available options.

Phone

Pair your Bluetooth-enabled phone with the system before using the functions in hands-free mode.

Switch on Bluetooth on your device to begin pairing. See your phone's manual if necessary.

To add a phone, select:

Menu Item
Add Phone

1. Follow the on-screen instructions.
2. A prompt alerts you to search for the system on your phone.

3. Select your vehicle's make and model as it displays on your phone.
4. Confirm that the six-digit number appearing on your phone matches the six-digit number on the touchscreen.
5. The touchscreen indicates when the pairing is successful.
6. Your phone may prompt you to give the system permission to access information. To check your phone's compatibility, see your phone's manual or visit the website.

Alternatively, to add a phone, select:

Menu Item
Add Phone
Then select:
Discover Other Bluetooth Devices

1. Follow the on-screen instructions.
2. Select your phone's name when it appears on the touchscreen.

SYNC™ 3 (If Equipped)

3. Confirm that the six-digit number appearing on your phone matches the six-digit number on the touchscreen.
4. The touchscreen indicates when the pairing is successful.
5. Your phone may prompt you to give the system permission to access information. To check your phone's compatibility, see your phone's manual or visit the website.

To check your phone's compatibility, see your phone's manual or visit the website:

Website
<p>owner.ford.com www.syncmyride.ca www.syncmaroute.ca</p>

Other features, such as text messaging using Bluetooth and automatic phonebook download, are phone-dependent features.

Once you have paired a device you can adjust the following options.

Menu Item	Action and Description
View Devices	
You can then select:	
Add a Bluetooth Device	You can add a Bluetooth-enabled device by following the steps in the previous table.
You can select a phone by touching the name of the phone on the screen. You then have the following options:	
Connect	Depending on the status of the device, you can select either of these options to interact with the selected device.
Disconnect	
Device Information	Allows you to see phone and device information.
Make Primary	Allows you to select this device to be your preferred device.
Delete	Removes the selected device from the system.

Menu Item	Action and Description
Manage Contacts	
You can then select:	
Auto-Download Contacts	Enable this option to have SYNC 3 periodically re-download your phonebook to keep your contact list up to date.
Sort By:	Choose how you would like the system to display your contacts. You can choose:

SYNCTM 3 (If Equipped)

Menu Item	Action and Description	
	First Name	Last Name
Re-download Contacts	Select this option to re-download your contact list manually.	
Delete Contacts	Select this option to delete the in vehicle contact list. Deleting the in vehicle list does not erase the contact list on the connected phone.	

Menu Item	Action and Description	
Set Phone Ringtone		
You can then select:		
No Ringtone	No sound plays when a call comes to your phone.	
Use Phone Ringtone	The currently selected ringtone on your phone plays when you receive a call. This option may not be available for all phones. If this option is available, it is the default setting.	
You can also select one of the three available ringers.		

Menu Item	Action and Description	
Text Messaging		
You can then select:		
No Alert (Silence)	No sound plays when a message comes to your phone.	
You can select one of the three available notification sounds.		
Voice Readout	When enabled, a voice prompt alerts you when you receive a new message.	

SYNC™ 3 (If Equipped)

You can enable and disable the following options as well:

Menu Item	Action and Description
Mute Audio in Privacy	When enabled, vehicle audio (such as radio or apps) is muted for the duration of the phone call even when the phone call is in privacy.
Roaming Warning	When enabled, an alert displays that your phone is roaming when you attempt to place a call.
Low Battery Notification	When enabled, a message displays when the battery on your phone is running low.

911 Assist

Note: *This service is only available in the United States and Canada.*

Select this button to modify the on or off setting for this feature. If the mobile phone's contacts have been downloaded, you can adjust the following option:

Menu Item	Action and Description
Set Emergency Contacts	You can select up to two numbers from your mobile device's phone-book as emergency contacts for quick access at the end of the 911 Assist call process.

Radio

This button is available if a Radio source such as AM or FM is the active media source. Pressing the button allows you to access the following features:

SYNCTM 3 (If Equipped)

Menu Item	Action and Description
FM HD Radio AM HD Radio (Dependent on current radio source, If Available)	Activation of this feature allows you to listen to HD radio broadcasts.
Radio Text	This feature is available when FM Radio is your active media source. Activate this feature to have the system display radio text.
Autoset Presets (AST)	Refresh
	Selecting this option stores the six strongest stations in your current location to the last preset bank of the currently tuned source.

Navigation

You can adjust many of the Navigation preferences by selecting the following menus.

Map Preferences

Menu Item	Action and Description
Map Preferences	
Then select any of the following:	
3D City Model	When this option is active, the system shows 3D renderings of buildings.
Breadcrumbs	When enabled, your vehicle's previously traveled route displays with white dots.
POI Icons	Enable this feature to display up to 3 POI icons on the navigation map.
	Once this feature is activated you can select the icons you want displayed by selecting:
Incident Map Icons	This menu allows you to choose which incident icons you would like to have displayed on the navigation map.

SYNC™ 3 (If Equipped)

Route Preferences

Menu Item	Second Level Messages, Actions and Descriptions		
Route Preferences			
Then select any of the following:			
Preferred Route	Choose to have the system display your chosen route type.		
	<table border="1"> <tr> <td>Shortest</td> <td>Fastest</td> <td>Eco</td> </tr> </table>	Shortest	Fastest
Shortest	Fastest	Eco	
Always Use ___ Route	Bypass route selection in destination programming. The system only calculates one route based on your preferred route setting. When activated, the system uses your selected route type to calculate only one route to the desired destination.		
Use HOV Lanes	The system selects High Occupancy Vehicle or car pool lanes when providing route guidance.		
Automatically Find Parking	The system searches for and displays available parking locations as you approach your destination.		
Eco Time Penalty	Select a level of cost for the calculated Eco Route. The higher the setting, the longer the time allotment is for the route.		
Dynamic Route Guidance	Enable or disable considering traffic information when planning a route. The system can find a faster route based on heavy traffic flow information or detect a Road Closed incident and find a detour route if possible.		
Avoid Freeways	If selected, SYNC 3 avoids freeways when computing a navigation route.		
Avoid Toll Roads	If selected, SYNC 3 avoids Toll Roads when computing a navigation route.		
Avoid Ferries/Car Trains	If selected, SYNC 3 avoids the use of Ferries or Trains when computing a navigation route.		

SYNC™ 3 (If Equipped)

Navigation Preferences

Menu Item	Action and Description
Navigation Preferences	
Guidance Prompts	You can adjust how the system provides prompts.
Then select any of the following:	
Voice and Tones	A tone sounds followed by voice instructions.
Voice Only	Only voice instructions are given.
Tones Only	Only a tone sounds to prompt you.

Mobile Apps

You can enable the control of compatible mobile apps running on your Bluetooth or USB device on SYNC 3. In order to enable mobile apps, SYNC 3 requires user consent to send and receive app authorization information and updates using the data plan associated with the connected device.

The connected devices sends data to Ford in the United States. The encrypted information includes your VIN, SYNC 3 module number, anonymous usage statistics and debugging information. Updates may take place automatically.

Note: All Mobile Apps may not be compatible with the system.

Note: Standard data rates will apply. Ford is not responsible for any additional charges you may receive from your service provider, when your vehicle sends or receives data through the connected device. This includes any additional charges incurred due to driving in areas when roaming out of a home network.

Menu Item	Action and Description
Mobile Apps	Enable or disable the use of mobile apps on SYNC 3. Disabling mobile apps in the settings menu disables automatic updates and the use of mobile apps on SYNC 3.
	You can view the status of mobile app permissions in the settings menu.
Once Mobile Apps is enabled, you have the following options:	
Update Mobile Apps	This provides information on the current state of available app updates.
	There are three possible statuses:

SYNC™ 3 (If Equipped)

Menu Item	Action and Description		
	Update Needed	Up-To-Date	Updating Mobile Apps...
	The system has detected a new app requiring authorization or a general permissions update is required.	No update is required.	The system is trying to receive an update.
	Request Update		Select this button if an update is required and you want to request this update manually. For example, when your mobile device is connected to a Wi-Fi hotspot, select: Request Update
All Apps	Grant or deny permissions to all apps at once.		
There may also be SYNC 3 enabled apps listed under these options.	Grant or deny an individual app particular permissions. App permissions are organized into groups. By pressing the info book icon, you can see which signals are included in each group.		

Note: Ford is not responsible or liable for any damages or loss of privacy relating to usage of an app, or dissemination of any vehicle data that you approve Ford to provide to an app.

General

Access and adjust the system settings, voice features, as well as phone, navigation and wireless settings.

Menu Item	
Language	Select to have the touchscreen display in English, Spanish or French.
Distance	Select to display units in kilometers or miles.
Temperature	Select to display units in Celsius or Fahrenheit.
Touch Screen Beep	Select to have the system beep to confirm choices made through the touchscreen.

SYNC™ 3 (If Equipped)

Menu Item	
Automatic System Updates	When you activate this option, the system automatically updates when you have an available Internet connection through a Wi-Fi network or mobile connection.
About	Information pertaining to the system and its software.
Software Licenses	Documentation of the software license for the system.
Master Reset	Select to restore factory defaults. This erases all personal settings and personal data.

Wi-Fi

You can adjust the following:

Menu Item	Action and Description
Wi-Fi	Enable this option to connect to Wi-Fi for SYNC 3 vehicle software updates.
View Available Networks	This provides you with a list of available Wi-Fi networks within range.
	Clicking on a network from the list allows you to connect or disconnect from that network. The system may require a security code to connect.
	When you click the information button next to a network, more information about the network displays such as the signal strength, connection status and security type.
Wi-Fi Available Notifications	The system alerts you when your vehicle is parked and a Wi-Fi network is within range if SYNC is not already connected.

Vehicle

Note: *You vehicle may not have all of these features.*

You can select the following features to update their settings.

Door Keypad Code

Select this button to add or erase a personal door keypad code. To add or erase a personal code, you first need to enter the five-digit factory set code. You can find this code on the owner's wallet card in the glove box or from your authorized dealer.

SYNC™ 3 (If Equipped)

Camera Settings

To make adjustments using the touchscreen, select:

Message	Action and Description
Camera Settings	
Then select from the following:	
Rear Camera Delay	You can enable or disable this option using the slider.

You can find more information on the rear-view camera system in the parking aids chapter of your owner manual.

Onboard Modem Serial Number (ESN)

Selecting this button on the settings menu shows you the ESN number for your system. You need this number for certain registrations such as Satellite Radio.

Display

To make adjustments using the touchscreen, select:

Menu Item	Action and Description	
Brightness	Make the screen display brighter or dimmer.	
Mode	You can select:	
	Auto	The screen automatically switches between day and night modes based on the outside light level.
	Day	The screen displays with a light background to enhance daytime viewing.
	Night	The screen displays with a darker background to make nighttime viewing easier.
Off	The screen goes black and does not display anything. To switch the screen back on, simply tap the screen.	
Auto Dim	Enable this option to automatically dim the display brightness based on ambient lighting conditions.	

SYNC™ 3 (If Equipped)

Voice Control

You can adjust the voice control settings by selecting the following options.

Menu Item	
Advanced Mode	Enable this option to remove additional voice prompts and confirmations.
Phone Confirmation	Enable this option to have the system confirm a contacts name with you before making a call.
Voice Command List	Enable this option to have the system display a list of available voice commands when the voice button is pressed.

Valet Mode

Valet mode allows you to lock the system. No information is accessible until the system is unlocked with the correct PIN.

When you select valet mode a pop up appears informing you that a four digit code must be entered to enable and disable valet mode. You can use any PIN you chose but you must use the same PIN to disable valet mode. The system asks you to input the code.

Note: *If the system is locked and you cannot remember the PIN, please contact the Customer Relationship Center.*

United States: 1-800-392-3673

Canada: 1-800-565-3673

To enable valet mode, enter your chosen PIN. The system then asks to confirm your PIN by reentering it. The system then locks.

To unlock the system, enter the same pin number. The system reconnects to your phone and all of your options are available again.

SYNC™ 3 TROUBLESHOOTING

Your SYNC 3 system is easy to use. However, should questions arise, please refer to the tables below.

To check your cell phone's compatibility, visit the Ford website.

Website
owner.ford.com www.syncmyride.ca www.syncmaroute.ca

SYNC™ 3 (If Equipped)

Cell phone issues		
Issue	Possible cause	Possible solution
There is background noise during a phone call.	The audio control settings on your cell phone may be affecting SYNC 3 performance.	Refer to your device's manual about audio adjustments.
During a call, I can hear the other person but they cannot hear me.	Possible cell phone malfunction.	Try switching your cell phone off, resetting it or removing the battery, then try again.
		Make sure that the microphone for SYNC 3 is not set to off. Look for the microphone icon on the phone screen.
During a call, I cannot hear the other person and they cannot hear me.	The system may need to be restarted.	To restart your system, shut down the engine, open and close the door, and then lock the door and wait for 2-3 minutes. Make sure that your SYNC 3 screen is black and the lighted USB port is off.
SYNC 3 is not able to download my phonebook.	This is a cell phone-dependent feature.	Check your cell phone's compatibility.
	Possible cell phone malfunction.	Make sure you allow SYNC 3 to retrieve contacts from your phone. Refer to your cell manual.
		You must switch on your cell phone and the automatic phonebook download feature on SYNC 3.
Try switching your cell phone off, resetting it or removing the battery, then try again.		
The system says "Phonebook downloaded" but my SYNC 3 phonebook is empty or is missing contacts.	Limitations on your cell phone's capability.	Make sure you allow SYNC 3 to retrieve contacts from your phone. Refer to your cell manual.
		If the missing contacts are stored on your SIM card, move them to your cell phone's memory.
		You must switch on your cell phone and the automatic phonebook download feature on SYNC 3.

SYNC™ 3 (If Equipped)

Cell phone issues		
Issue	Possible cause	Possible solution
I am having trouble connecting my cell phone to SYNC 3.	This is a cell phone-dependent feature.	Check your cell phone's compatibility.
	Possible cell phone malfunction.	Try switching your cell phone off, resetting it or removing the battery, then try again.
		Try deleting your device from SYNC 3 and deleting SYNC from your device, then trying again.
		Always check the security and auto accept prompt settings relative to the SYNC 3 Bluetooth connection on your cell phone.
		Update your cell phone's firmware.
		Switch the auto download setting off.
Text messaging is not working on SYNC 3.	This is a cell phone-dependent feature.	Check your cell phone's compatibility.
	Possible cell phone malfunction.	Try switching your cell phone off, resetting it or removing the battery, then try again.
	iPhone	<ul style="list-style-type: none"> • Go to your cell phone's Settings. • Go to the Bluetooth Menu. • Press the blue circle to the right of the device named with your vehicle make and model to enter the next menu. • Turn Show Notifications on. • Disconnect then reconnect your iPhone from the SYNC 3 system to activate this settings update. <p>Your iPhone is now set up to forward incoming text messages to SYNC 3. Repeat these steps for every other SYNC 3 vehicle that you connect. Your iPhone will only forward incoming text messages to SYNC 3 if the iPhone is not unlocked in the messaging application. Replying to text messages using SYNC 3 is not supported by iPhone.</p>

SYNC™ 3 (If Equipped)

Cell phone issues		
Issue	Possible cause	Possible solution
		Text messages from WhatsApp and Facebook Messenger are not supported.
Audible text messages do not work on my cell phone.	This is a cell phone-dependent feature.	Your cell phone must support downloading text messages through Bluetooth to receive incoming text messages.
	This is a cell phone limitation.	Because each cell phone is different, refer to your device's manual for the specific cell phone you are pairing. In fact, there can be differences between cell phones due to brand, model, service provider and software version.

USB and Bluetooth Stereo issues		
Issue	Possible cause	Possible solution
I am having trouble connecting my device.	Possible device malfunction.	Disconnect the device from SYNC 3. Try switching your device off, resetting it or removing the battery, then reconnect it to SYNC 3.
		Make sure you are using the manufacturer's cable.
		Make sure to correctly insert the USB cable into the device and your vehicle's USB port.
	Make sure that the device does not have an auto-install program or active security settings.	
	The device has a lock screen enabled.	Make sure your device is unlocked before connecting it to SYNC 3.
SYNC 3 does not recognize my device when I start my vehicle.	This is a device limitation.	Make sure you are not leaving the device in your vehicle during very hot or cold temperatures.
Bluetooth audio does not stream.	This is a device-dependent feature.	Make sure you connect the device to SYNC 3 and that you have started the media player on your device.

SYNC™ 3 (If Equipped)

USB and Bluetooth Stereo issues		
Issue	Possible cause	Possible solution
	The device is not connected.	
SYNC 3 does not recognize music that is on my device.	Your music files may not contain the correct artist, song title, album or genre information.	Make sure that all song details are populated.
	The file may be corrupted.	Try replacing the corrupt file with a new version.
	The song may have copyright protection that does not allow it to play.	Some devices require you to change the USB settings from mass storage to media transfer protocol class.
	The file format is not supported by SYNC 3.	Convert the file to a supported format. See Entertainment (page 363).
	The device needs to be re-indexed.	Update media index. See Settings (page 393).
	The device has a lock screen enabled.	Make sure your device is unlocked before connecting it to SYNC 3.
When I connect my device, I sometimes do not hear any sound.	This is a device limitation.	Disconnect the device from SYNC 3. Try switching your device off, resetting it or removing the battery, then connect it back to SYNC 3.
		To listen to Apple devices through USB, select AirPlay from the devices Control Center, then select Dock Connector.
		To listen to Apple devices through Bluetooth Stereo, select AirPlay from the devices Control Center, then select SYNC.

SYNC™ 3 (If Equipped)

Wi-Fi Issues		
Issue	Possible cause	Possible solution
Failed connection.	Password error.	Verify password.
	Weak signal.	Check for a poor Wi-Fi signal.
	Multiple Access points within range with the same SSID.	Use a unique name for your SSID, don't use the default name unless it contains a unique identifier, such as part of the MAC address.
Disconnecting after successful connection.	Weak signal probably due to distance from the hotspot, obstruction or high interference.	Position the vehicle close to the hotspot with the front of the vehicle facing the hotspot direction and remove obstacles if possible. Other Wi-Fi, Bluetooth, microwave and cordless phones may cause interference.
Poor signal seen by SYNC 3 despite being near a hotspot.	There may be an obstruction between SYNC 3 and the hotspot.	If the vehicle is equipped with heated windshield, try positioning the vehicle so that the windshield is not facing the hotspot. If you have metallic window tinting but not on the windshield, position the vehicle to face the hotspot. If all windows are tinted, you can open the windows in the direction of the hotspot if that is feasible. Try to remove other obstructions that may impact signal quality such as opening the garage door.
A hotspot is not listed in the list of available networks.	The hotspot was defined as a hidden network.	Please set the network to visible and try again.

SYNC™ 3 (If Equipped)

Wi-Fi Issues		
Issue	Possible cause	Possible solution
SYNC 3 is not seen when searching for Wi-Fi networks from your phone or other devices.	SYNC 3 does not currently provide a hotspot.	SYNC 3 currently does not provide a hotspot
Software download takes too long.	Poor signal strength, too far from the hotspot, hotspot is supporting multiple connections, slow Internet connection or other problems.	Check the signal quality (under network details), if SYNC 3 indicates good or excellent, test with another high-speed equipped hotspot where the environment is more predictable.
SYNC 3 seems to connect with a hotspot and the signal strength is excellent but the software is not being updated.	It is possible that there is no new software. The connected hotspot may be a managed one and it requires either a subscription or agreeing to the terms and conditions.	Test the connection with another device, if the hotspot requires a subscription, you may contact the service provider.

AppLink issues		
Issue	Possible cause(s)	Possible solution(s)
AppLink Mobile Applications: When I select "Connect Mobile Apps," SYNC 3 does not find any applications.	You did not connect an AppLink Compatible phone to SYNC 3.	Make sure you have a compatible smartphone; an Android with OS 2.3 or higher or an iPhone 3GS or newer with iOS 5.0 or higher. Additionally, make sure you pair and connect your phone

SYNC™ 3 (If Equipped)

AppLink issues		
Issue	Possible cause(s)	Possible solution(s)
		to SYNC 3 in order to find AppLink-capable apps on your device. iPhone users must also connect to a USB port with an Apple USB cable.
My phone is connected, but I still cannot find any apps.	AppLink-enabled apps are not installed and running on your mobile device.	Make sure you have downloaded and installed the latest version of the app from your phone's app store. Make sure the app is running on your phone. Some apps require you to register or login to the app on the phone before using them with AppLink. Also, some may have a "Ford SYNC" setting, so check the app's settings menu on the phone.
My phone is connected, my app(s) are running, but I still cannot find any apps.	Sometimes apps do not properly close and re-open their connection to SYNC 3, over ignition cycles, for example.	Closing and restarting apps may help SYNC 3 find the application if you cannot discover it inside the vehicle. On an Android device, if apps have an 'Exit' or 'Quit' option, then select it and restart the app. If the app does not have that option, select the phone's settings menu and select 'Apps', then find the particular app and choose 'Force stop.' Do not forget to restart the app afterward, then select "Connect Mobile Apps" on SYNC 3.

SYNC™ 3 (If Equipped)

Applink issues		
Issue	Possible cause(s)	Possible solution(s)
		On an iPhone with iOS7+, to force close an app, double tap the home button then swipe up on the app to close it. Tap the home button again, then select the app again to restart it. After a few seconds, the app should then appear in SYNC 3's Mobile App's Menu.
My Android phone is connected, my app(s) are running, I restarted them, but I still cannot find any apps.	There is a Bluetooth issue on some older versions of the Android operating system that may cause apps that were found on your previous vehicle drive to not be found again if you did not switch Bluetooth off.	Switch Bluetooth off and then on to reset it on your phone. If you are in your vehicle, SYNC 3 should be able to automatically re-connect to your phone if you press the "Phone" button.

SYNC™ 3 (If Equipped)

AppLink issues		
Issue	Possible cause(s)	Possible solution(s)
My iPhone is connected, my app is running, I restarted the app but I still cannot find it on SYNC 3.	You may need to reset the USB connection to SYNC 3.	Unplug the USB cable from the phone, wait a moment, and plug the USB cable back in to the phone. After a few seconds, the app should appear in SYNC 3's Mobile Apps Menu. If not, "Force Close" the application and restart it.
I have an Android phone. I found and started my media app on SYNC 3, but there is no sound or the sound is very low.	The Bluetooth volume on the phone may be low.	Increase the Bluetooth volume of the device by using the device's volume control buttons which are most often found on the side of the device.
I can only see some of the AppLink apps running on my phone listed in the SYNC 3 Mobile Apps Menu.	Some Android devices have a limited number of Bluetooth ports that apps can use to connect. If you have more AppLink apps on your phone than the number of available Bluetooth ports, you will not see all of your apps listed in the SYNC 3 mobile apps menu.	Force close or uninstall the apps you do not want SYNC 3 to find. If the app has a "Ford SYNC" setting, disable that setting in the app's settings menu on the phone.

Voice command issues		
Issue	Possible cause	Possible solution
SYNC 3 does not understand what I am saying.	You may be using the wrong voice commands.	Review the cell phone voice commands and the media voice commands at the beginning of their respective sections.
	You may be speaking too soon or at the wrong time.	Refer to the audio display during an active voice session to find a list of voice commands there. Wait for the system to prompt you before you state your command.

SYNC™ 3 (If Equipped)

Voice command issues		
Issue	Possible cause	Possible solution
SYNC 3 does not understand the name of a song or artist.	You may be using the wrong voice commands.	Review the media voice commands at the beginning of the media section.
	You may not be saying the name exactly as it appears on your device.	Say the song or artist name exactly as it is displayed on your device. For example, say "Play Artist Prince" or "Play song Purple Rain".
		Make sure you are saying the complete title such as "California remix featuring Jennifer Nettles".
	If there are any abbreviations in the name, like ESPN or CNN, you have to spell those: "E-S-P-N" or "C-N-N".	
The song or artist name may have some special characters that are not being recognized by SYNC 3.	Make sure that song titles, artists, album, and playlists names do not have any special characters like *, - or +.	
SYNC 3 does not understand or is calling the wrong contact when I want to make a call.	You may not be saying the name exactly as it appears on your phone-book.	Make sure that you are saying the name exactly as it appears on your phone. For example, if your contact is "Joe Wilson", say "Call Joe Wilson". If your contact name is "Mom", say "Call Mom".
	The contact name may contain special characters.	Make sure that your contact names do not have any special characters like *, - or +.
The SYNC 3 voice control system is having trouble recognizing foreign names stored on my cell phone.	You may not be saying the name exactly as it appears on your phone-book.	SYNC 3 applies the phonetic pronunciation rules of the selected language to the contact names stored on your cell phone.
		Helpful Hint: You can select your contact manually. Press PHONE . Select the option for phonebook and then contact name. Press the soft-key option to hear it. SYNC 3 will read the contact name to you, giving you some idea of the pronunciation it is expecting.

SYNC™ 3 (If Equipped)

Voice command issues		
Issue	Possible cause	Possible solution
<p>The SYNC 3 voice control system is having trouble recognizing foreign tracks, artists, albums, genres and playlist names from my media player or USB flash drive.</p>	<p>You may be saying the foreign names using the currently selected language for SYNC 3.</p>	<p>SYNC 3 applies the phonetic pronunciation rules of the selected language to the names stored on your media player or USB flash drive. It is able to make some exceptions for very popular artist names (for example, U2) such that you can always use the English pronunciation for these artists.</p>
<p>The system generates voice prompts and the pronunciation of some words may not be accurate for my language.</p>	<p>SYNC 3 uses text-to-speech voice prompt technology.</p>	<p>SYNC 3 uses a synthetically generated voice rather than pre-recorded human voice.</p> <p>SYNC 3 offers several new voice control features for a wide range of languages. Dialing a contact name directly from the phonebook without pre-recording (for example, "call John Smith") or selecting a track, artist, album, genre or playlist directly from your media player (for example, "play artist Madonna").</p>

SYNC™ 3 (If Equipped)

General		
Issue	Possible cause	Possible solution
<p>The language selected for the instrument cluster and information and entertainment display does not match the SYNC 3 language (phone, USB, Bluetooth audio, voice control and voice prompts).</p>	<p>SYNC 3 does not support the currently selected language for the instrument cluster and information and entertainment display.</p>	<p>SYNC 3 only supports four languages in a single module for text display, voice control and voice prompts. The country where you bought your vehicle dictates the four languages based on the most popular languages spoken. If the selected language is not available, SYNC 3 remains in the current active language.</p> <p>SYNC 3 offers several new voice control features for a wide range of languages. Dialing a contact name directly from the phonebook without pre-recording (for example, "call John Smith") or selecting a track, artist, album, genre or playlist directly from your media player (for example, "play artist Madonna").</p>

SYNC 3 System Reset
<p>The system has a System Reset feature that can be performed if the function of a SYNC 3 feature is lost. This reset is intended to restore functionality and will not erase any information previously stored in the system (such as paired devices, phonebook, call history, text messages, or user settings). To perform a System Reset, press and hold the Seek Up (>>) button while pressing and holding the Radio Power button. After approximately 5 seconds the screen will go black. Allow 1-2 minutes for the system reset to complete. You may then resume using the SYNC 3 system.</p>

For additional assistance with SYNC 3 troubleshooting please call or visit the Ford Website.

Ford Support	
Customer Relationship Center	<p>United States: 1-800-392-3673</p> <p>Canada: 1-800-565-3673</p>
Website	<p>owner.ford.com</p> <p>www.syncmyride.ca</p> <p>www.syncmaroute.ca</p>

Accessories

For a complete listing of the accessories that are available for your vehicle, please contact your authorized dealer or visit the online store web site:

Web Address (United States)

www.Accessories.Ford.com

Web Address (Canada)

www.Accessories.Ford.ca

Ford Motor Company will repair or replace any properly authorized dealer-installed Ford Original Accessory found to be defective in factory-supplied materials or workmanship during the warranty period, as well as any component damaged by the defective accessories.

Ford Motor Company will warrant your Ford accessory through the warranty that provides the greatest benefit:

- 24 months, unlimited mileage.
- The remainder of your new vehicle limited warranty.

Contact an authorized dealer for details and a copy of the warranty.

Exterior Style

- Custom graphics*.
- Hood protector*.
- Rear spoilers.
- Wheel center caps.
- Wheels.

Interior Style

- Ambient lighting.
- Floor mats.
- Illuminated sill plates.
- Shift knobs.
- Sport pedals.

Lifestyle

- Ash cup (smoker's packages).
- Cargo area protector.
- Cargo net.
- Soft cargo organizers.
- Tablet cradle.

Peace of Mind

- Bumper-mounted parking assist system*.
- Full vehicle covers.
- Remote start.
- Roadside assistance kit.
- Temporary spare tire kit.
- Vehicle security systems.
- Wheel locks.

*Ford Licensed Accessory. The accessory manufacturer designs, develops and therefore warrants Ford Licensed Accessories, and does not design or test these accessories to Ford Motor Company engineering requirements. Contact an authorized Ford dealer for the manufacturer's limited warranty details and request a copy of the Ford Licensed Accessories product limited warranty from the accessory manufacturer.

Accessories

For maximum vehicle performance, keep the following information in mind when adding accessories, equipment, passengers and luggage to your vehicle:

- Do not exceed the total weight capacity of the vehicle or of the front or rear axle (GVWR or GAWR as indicated on the Safety Compliance Certification label). Consult an authorized dealer for specific weight information.
- The Federal Communications Commission (FCC) and Canadian Radio Telecommunications Commission (CRTC) regulate the use of radio transmitter-equipped mobile communications systems, for example, two-way radios, telephones and theft alarms. Any such equipment should comply with the Federal Communications Commission (FCC) and Canadian Radio Telecommunications Commission (CRTC) regulations, and an authorized dealer should install this equipment.
- An authorized dealer should install mobile communications systems. Improper installation may harm the operation of your vehicle, particularly if their manufacturer did not design the mobile communication system specifically for automotive use.
- If you or an authorized dealer add any non-Ford electrical or electronic accessories or components to your vehicle, you may adversely affect battery performance and durability. In addition, you may also adversely affect the performance of other electrical systems in the vehicle.

Ford Protect

PROTECT YOURSELF FROM THE RISING COST OF VEHICLE REPAIRS WITH A FORD PROTECT EXTENDED SERVICE PLAN.

Ford Protect Extended Service Plans (U.S. Only)

Ford Protect Extended Service Plan means peace of mind. It's the extended service plan backed by Ford Motor Company, and provides more protection beyond the New Vehicle Limited Warranty coverage. When you visit your Ford Dealer, Insist on Ford Protect Extended Service Plans!

Ford Protect Can Quickly Pay for Itself

One trip to the Service Center could easily exceed the price of your Ford Protect Extended Service Plan. With Ford Protect you minimize your risk for unexpected repair bills and rising repair costs.

Up to 1,000+ Covered Vehicle Components

There are four mechanical Ford Protect Extended Service Plans with different levels of coverage. Ask your authorized dealer for details.

1. PremiumCARE - Our most comprehensive coverage. With over 1,000 covered components, this plan is so complete it's probably easier to list what's not covered.
2. ExtraCARE - Covers 113 components, and includes many high-tech items.
3. BaseCARE - Covers 84 components.
4. PowertrainCARE - Covers 29 critical components.

Ford Protect Extended Service Plans are honored by all authorized Ford dealers in the U.S., Canada and Mexico.

That means you get:

- Reliable, quality service at any Ford or Lincoln dealership.
- Repairs performed by factory trained technicians, using genuine parts.

Rental Car Reimbursement

1st day Rental Benefit

If you bring your car into your dealer for service, we'll give you a loaner to use for the day.

Extended Rental Benefits

If your vehicle is kept overnight for covered repairs, you are eligible for rental car coverage, including warranty repairs, and Field Service Actions.

Roadside Assistance

Exclusive 24/7 roadside assistance, including:

- Towing, flat-tire change and battery jump starts.
- Out of fuel and lock-out assistance.
- Travel expense reimbursement for lodging, meals and rental car.
- Assistance for taxi, shuttle, rental car coverage or other transportation.

Transferable Coverage

If you sell your vehicle before your Ford Protect Extended Service plan coverage expires, you can transfer any remaining coverage to the new owner. Which should give you and your potential buyer a little more peace of mind.

Ford Protect

Less Cost to Properly Maintain Your Vehicle

Ford Protect Extended Service Plan also offers a Premium Maintenance Plan that covers all scheduled maintenance, and selected wear items. The coverage is prepaid, so you never have to worry about the cost of your vehicle's maintenance.

Covered maintenance includes:

- Windshield wiper blades.
- Spark plugs.
- The clutch disc.
- Brake pads and linings.
- Shock absorbers.
- Struts.
- Engine Belts.
- Engine coolant hoses, clamps and o-rings.
- Diesel exhaust fluid replenishment.
- Cabin air filter replacement every 20,000 mi (32,000 km) (electric vehicles only).

Interest Free Finance Options

Just a 10% down payment will provide you with an affordable, no interest, no fee payment program allowing you all the security and benefits Ford Protect Extended Service Plan has to offer while paying over time. You are pre-approved with no credit check or hassles. To learn more, call our Ford Protect Extended Service Plan specialists at 800-367-3377.

Ford Protect Extended Service Plan
P.O. Box 321067
Detroit, MI 48232

Ford Protect Extended Service Plan (CANADA ONLY)

You can get more protection for your vehicle by purchasing a Ford Protect Extended Service Plan. Ford Protect Extended Service Plan is the only service contract backed by Ford Motor Company of Canada, Limited. Depending on the plan you purchase, Ford Protect Extended Service Plan provides benefits such as:

- Rental reimbursement.
- Coverage for certain maintenance and wear items.
- Protection against repair costs after your New Vehicle Limited Warranty Coverage expires.
- Roadside Assistance benefits.

There are several Ford Protect Extended Service Plans available in various time, distance and deductible combinations. Each plan is tailored to fit your own driving needs, including reimbursement for towing and rental. When you purchase Ford Protect Extended Service Plan, you receive added peace-of-mind protection throughout Canada, the United States and Mexico, provided by a network of participating authorized Ford Motor Company dealers.

Note: *Repairs performed outside of Canada, the United States and Mexico are not eligible for Ford Protect Extended Service Plan coverage.*

This information is subject to change. For more information; visit your local Ford of Canada dealer or www.ford.ca to find the Ford Protect Extended Service Plan that is right for you.

Scheduled Maintenance

GENERAL MAINTENANCE INFORMATION

Why Maintain Your Vehicle?

Carefully following the maintenance schedule helps protect against major repair expenses resulting from neglect or inadequate maintenance and may help to increase the value of your vehicle when you sell or trade it. Keep all receipts for completed maintenance with your vehicle.

We have established regular maintenance intervals for your vehicle based upon rigorous testing. It is important that you have your vehicle serviced at the proper times. These intervals serve two purposes; one is to maintain the reliability of your vehicle and the second is to keep your cost of owning your vehicle down.

It is your responsibility to have all scheduled maintenance performed and to make sure that the materials used meet the specifications identified in this owner's manual. See **Capacities and Specifications** (page 271).

Failure to perform scheduled maintenance invalidates warranty coverage on parts affected by the lack of maintenance.

Why Maintain Your Vehicle at Your Dealership?

Factory-Trained Technicians

Service technicians participate in extensive factory-sponsored certification training to help them become experts on the operation of your vehicle. Ask your dealership about the training and certification their technicians have received.

Genuine Ford and Motorcraft® Replacement Parts

Dealerships stock Ford, Motorcraft and Ford-authorized branded re-manufactured replacement parts. These parts meet or exceed our specifications. Parts installed at your dealership carry a nationwide 24-month or unlimited mile (kilometer) parts and labor limited warranty.

If you do not use Ford authorized parts they may not meet our specifications and depending on the part, it could affect emissions compliance.

Convenience

Many dealerships have extended evening and Saturday hours to make your service visit more convenient and they offer one stop shopping. They can perform any services that are required on your vehicle, from general maintenance to collision repairs.

Note: *Not all dealers have extended hours or body shops. Please contact your dealer for details.*

Protecting Your Investment

Maintenance is an investment that pays dividends in the form of improved reliability, durability and resale value. To maintain the proper performance of your vehicle and its emission control systems, make sure you have scheduled maintenance performed at the designated intervals.

Your vehicle is equipped with an intelligent oil-life monitor that determines oil life based on engine operating conditions.

Scheduled Maintenance

- Under normal operating conditions, a message appears in the information display to indicate the regular oil change interval.
- Under severe operating conditions, the oil change interval may be reduced, and the message interval will adjust accordingly.

High performance vehicles can be driven in such a way that may lead to higher oil consumption (this includes extended time at high engine speeds, high loads, engine braking, hard cornering maneuvers, and track use). Under these conditions, the engine oil level needs to be checked at every refueling and adjusted to maintain proper level to avoid engine damage.

Note: *Oil level should not exceed the maximum mark on the indicator. See **Engine Oil Check** (page 215).*

When the oil change message appears in the information display, it is time for an oil change. Make sure you perform the oil change within two weeks or 500 mi (800 km) of the message appearing. Make sure you reset the Intelligent Oil-Life Monitor after each oil change. See

General Information (page 83).

If your information display resets prematurely or becomes inoperative, you should perform the oil change interval at six months or 5,000 mi (8,000 km) from your last oil change. Never exceed one year or 10,000 mi (16,000 km) between oil change intervals.

Your vehicle is very sophisticated and built with multiple, complex, performance systems. Every manufacturer develops these systems using different specifications and performance features. That is why it is important to rely upon your dealership to properly diagnose and repair your vehicle.

Ford Motor Company has recommended maintenance intervals for various parts and component systems based upon engineering testing. Ford Motor Company relies upon this testing to determine the most appropriate mileage for replacement of oils and fluids to protect your vehicle at the lowest overall cost to you and recommends against maintenance schedules that deviate from the scheduled maintenance information.

We strongly recommend the use of only genuine Ford, Motorcraft or Ford-authorized re-manufactured replacement parts engineered for your vehicle.

Additives and Chemicals

This owner's manual and the Ford Workshop Manual list the recommended additives and chemicals for your vehicle. We do not recommend using chemicals or additives not approved by us as part of your vehicle's normal maintenance. Please consult your warranty information.

Oils, Fluids and Flushing

In many cases, fluid discoloration is a normal operating characteristic and, by itself, does not necessarily indicate a concern or that the fluid needs to be changed. However, a qualified expert, such as the factory-trained technicians at your dealership, should inspect discolored fluids that also show signs of overheating or foreign material contamination immediately.

Scheduled Maintenance

Make sure to change your vehicle's oils and fluids at the specified intervals or in conjunction with a repair. Flushing is a viable way to change fluid for many vehicle sub-systems during scheduled maintenance. It is critical that systems are flushed only with new fluid that is the same as that required to fill and operate the

system or using a Ford-approved flushing chemical.

Owner Checks and Services

Make sure you perform the following basic maintenance checks and inspections every month or at six-month intervals.

Check every month
Engine oil level (Normal vehicle use).
For severe use, (High engine speed and engine loads, engine braking and track use) check engine oil level every fuel fill-up.
Function of all interior and exterior lights.
Tires (including spare) for wear and proper pressure.
Windshield washer fluid level.

Check every six months
Battery connections. Clean if necessary.
Body and door drain holes for obstructions. Clean if necessary.
Cooling system fluid level and coolant strength.
Door weatherstrips for wear. Lubricate if necessary.
Hinges, latches and outside locks for proper operation. Lubricate if necessary.
Parking brake for proper operation.
Safety belts and seat latches for wear and function.
Safety warning lamps (brake, ABS, airbag and safety belt) for operation.
Washer spray and wiper operation. Clean or replace blades as necessary.

Scheduled Maintenance

Multi-Point Inspection

In order to keep your vehicle running right, it is important to have the systems on your vehicle checked regularly. This can help identify potential issues and prevent major

problems. We recommend having the following multi-point inspection performed at every scheduled maintenance interval to help make sure your vehicle keeps running great.

Multi-Point inspection	
Accessory drive belt(s)	Hazard warning system operation
Battery performance	Horn operation
Engine air filter	Radiator, cooler, heater and air conditioning hoses
Exhaust system	Suspension components for leaks or damage
Exterior lamps operation	Steering and linkage
Fluid levels*; fill if necessary	Tires (including spare) for wear and proper pressure**
For oil and fluid leaks	Windshield for cracks, chips or pits
Half-shaft dust boots	Washer spray and wiper operation

* Brake, coolant recovery reservoir, automatic transmission and window washer

**If your vehicle is equipped with a temporary mobility kit, check the tire sealant expiration Use By date on the canister. Replace as needed.

Be sure to ask your dealership service advisor or technician about the multi-point vehicle inspection. It is a comprehensive way to perform a thorough inspection of your vehicle. Your checklist gives you immediate feedback on the overall condition of your vehicle.

NORMAL SCHEDULED MAINTENANCE

Intelligent Oil-Life Monitor™

Your vehicle is equipped with an Intelligent Oil-Life Monitor that determines when you should change the engine oil based on how your vehicle is used. By using several important factors in its calculations, the monitor helps reduce the cost of owning your vehicle and reduces environmental waste at the same time.

Scheduled Maintenance

This means you do not have to remember to change the oil on a mileage-based schedule. Your vehicle lets you know when an oil change is due by displaying a message in the information display.

The following table provides examples of vehicle use and its impact on oil change intervals. It is a guideline only. Actual oil change intervals depend on several factors and generally decrease with severity of use.

When to expect the message prompting you to change your oil	
Interval	Vehicle use and example
7,000–10,000 mi (12,000–16,000 km)	Normal
	Normal commuting with highway driving No, or moderate, load or towing Flat to moderately hilly roads No extended idling
5,000–7,000 mi (8,000–11,999 km)	Severe
	Moderate to heavy load or towing Mountainous or off-road conditions Extended idling Extended hot or cold operation High engine speeds and loads, engine braking and hard cornering
3,000–5,000 mi (4,800–7,999 km)	Extreme
	Maximum load or towing Extreme hot or cold operation

Normal Maintenance Intervals

At every oil change interval as indicated by the information display*
Change engine oil and filter.**
Rotate tires, inspect tire wear and measure tread depth.
Perform a multi-point inspection (recommended).
Inspect the automatic transmission fluid level (if equipped with dipstick). Consult your dealer for requirements.
Inspect the brake pads, rotors, hoses and parking brake.
Inspect the engine cooling system strength and hoses.

Scheduled Maintenance

At every oil change interval as indicated by the information display*

Inspect the exhaust system and heat shields.
Inspect rear axle and U-joints. Lubricate if equipped with grease fittings.
Inspect the half-shaft boots.
Inspect the steering linkage, ball joints, suspension, tie-rod ends, driveshaft and U-joints. Lubricate any areas with grease fittings.
Inspect the wheels and related components for abnormal noise, wear, looseness or drag.

* Do not exceed one year or 10,000 mi (16,000 km) between service intervals.

** Reset the Intelligent Oil-Life Monitor after engine oil and filter changes.

Other maintenance items¹

Every 20,000 mi (32,000 km)	Replace cabin air filter.
Every 30,000 mi (48,000 km)	Replace engine air filter.
At 100,000 mi (160,000 km)	Change engine coolant. ²
Every 100,000 mi (160,000 km)	Replace spark plugs.
	Inspect accessory drive belt(s). ³
Every 150,000 mi (240,000 km)	Change automatic transmission fluid and filter.
	Change manual transmission fluid.
	Replace accessory drive belt(s).
	Change rear axle fluid.

¹ Perform these maintenance items within 3,000 mi (4,800 km) of the last engine oil and filter change. Do not exceed the designated distance for the interval.

² Initial replacement at six years or 100,000 mi (160,000 km), then every three years or 50,000 mi (80,000 km).

³ After initial inspection, inspect every other oil change until replaced.

Scheduled Maintenance

SPECIAL OPERATING CONDITIONS SCHEDULED MAINTENANCE

If you operate your vehicle **primarily** in any of the following conditions, you need to perform extra maintenance, as indicated. If you operate your vehicle **occasionally** under any of these conditions, it is not necessary to perform the extra maintenance. For specific recommendations, see your dealership service advisor or technician.

Perform the services shown in the following tables when specified or within 3,000 mi (4,800 km) of a message appearing in the information display prompting you to change your oil.

- **Example 1:** The message comes on at 28,751 mi (46,270 km). Perform the 30,000 mi (48,000 km) automatic transmission fluid replacement.
- **Example 2:** The message has **not** come on, but the odometer reads 30,000 mi (48,000 km) (for example, the Intelligent Oil-Life Monitor was reset at 25,000 mi (40,000 km)). Perform the engine air filter replacement.

Towing a trailer or using a car-top carrier	
As required	Change engine oil and filter as indicated by the information display and perform services listed in the Normal Scheduled Maintenance chart.
Inspect frequently, service as required	Inspect rear axle and U-joints. Lubricate if equipped with grease fittings.
	See axle maintenance items under Exceptions .
Every 60,000 mi (96,000 km)	Change manual transmission fluid.
	Replace spark plugs.

Extensive idling or low-speed driving for long distances, as in heavy commercial use (such as delivery, taxi, patrol car or livery)	
As required	Change engine oil and filter as indicated by the information display and perform services listed in the Normal Scheduled Maintenance chart.
Inspect frequently, service as required	Replace cabin air filter.
Every 15,000 mi (24,000 km)	Inspect engine air filter. Replace as required.
Every 60,000 mi (96,000 km)	Replace spark plugs.

Scheduled Maintenance

Operating in dusty or sandy conditions (such as unpaved or dusty roads)	
Inspect frequently, service as required	Replace cabin air filter.
Every 15,000 mi (24,000 km)	Inspect engine air filter. Replace as required.
Every 5,000 mi (8,000 km)	Inspect the wheels and related components for abnormal noise, wear, looseness or drag.
	Rotate tires, inspect tires for wear and measure tread depth.
Every 5,000 mi (8,000 km) or six months	Change engine oil and filter.*
Every 50,000 mi (80,000 km)	Change manual transmission fluid.

*Reset your Intelligent Oil-Life Monitor after each engine oil and filter change.

Exclusive use of E85 (Flex fuel vehicles only)	
Every oil change interval	If ran exclusively on E85, fill the fuel tank full with regular unleaded fuel.

Exceptions

There are several exceptions to the Normal Schedule:

Rear Axle Maintenance

A rear axle fluid change or level check is not required unless a leak is suspected or the assembly has been submerged in water. During long periods of trailer towing with outside temperatures above 70°F (21°C), and at wide-open throttle for long periods above 45 mph (72 km/h), change the rear axle fluid every 30,000 mi (48,000 km) or three months, whichever comes first (if rear axle is filled with non-synthetic fluid). This interval can be waived and 150,000 mi (240,000km) service interval can continue if the rear axle

is filled with 75W85 synthetic gear fluid meeting Ford specification WSS-M2C942-A, part number XY-75W85-QL, or equivalent. Add friction modifier XL-3 (EST-M2C118-A) or equivalent for complete refill of Traction-Lok rear axles.

California Fuel Filter Replacement

If you register your vehicle in California, the California Air Resources Board has determined that the failure to perform this maintenance item does not nullify the emission warranty or limit recall liability before the completion of your vehicle's useful life. Ford Motor Company, however, urges you to have all recommended maintenance services performed at the specified intervals and to record all vehicle service.

Scheduled Maintenance

Hot Climate Oil Change Intervals

Vehicles operating in the Middle East, North Africa, Sub-Saharan Africa or locations with similar climates using an American Petroleum Institute (API) Certified for Gasoline Engines (Certification mark) oil of SM or SN quality, the normal oil change interval is 3,000 mi (4,800 km).

If the available API SM or SN oils are not available, then the oil change interval is 1,800 mi (2,900 km).

Engine Air Filter and Cabin Air Filter Replacement

The life of the engine air filter and cabin air filter is dependent on exposure to dusty and dirty conditions. Vehicles operated in these conditions require frequent inspection and replacement of the engine air filter and cabin air filter.

SCHEDULED MAINTENANCE RECORD

<input type="radio"/> Repair Order #:	Dealer stamp
<input type="radio"/> Distance:	
<input type="radio"/> Engine hours (optional):	
<input type="radio"/> Multi-point inspection (recommended): <input type="checkbox"/>	
<input type="radio"/> Signature:	

<input type="radio"/> Repair Order #:	Dealer stamp
<input type="radio"/> Distance:	
<input type="radio"/> Engine hours (optional):	
<input type="radio"/> Multi-point inspection (recommended): <input type="checkbox"/>	
<input type="radio"/> Signature:	

Scheduled Maintenance

<input type="radio"/> Repair Order #:	<p>Dealer stamp</p>
<input type="radio"/> Distance:	
<input type="radio"/> Engine hours (optional):	
<input type="radio"/> Multi-point inspection (recommended): <input type="checkbox"/>	
<input type="radio"/> Signature:	

<input type="radio"/> Repair Order #:	<p>Dealer stamp</p>
<input type="radio"/> Distance:	
<input type="radio"/> Engine hours (optional):	
<input type="radio"/> Multi-point inspection (recommended): <input type="checkbox"/>	
<input type="radio"/> Signature:	

Scheduled Maintenance

<input type="radio"/> Repair Order #:	Dealer stamp
<input type="radio"/> Distance:	
<input type="radio"/> Engine hours (optional):	
<input type="radio"/> Multi-point inspection (recommended): <input type="checkbox"/>	
<input type="radio"/> Signature:	

<input type="radio"/> Repair Order #:	Dealer stamp
<input type="radio"/> Distance:	
<input type="radio"/> Engine hours (optional):	
<input type="radio"/> Multi-point inspection (recommended): <input type="checkbox"/>	
<input type="radio"/> Signature:	

Scheduled Maintenance

<input type="radio"/> Repair Order #:	Dealer stamp
<input type="radio"/> Distance:	
<input type="radio"/> Engine hours (optional):	
<input type="radio"/> Multi-point inspection (recommended): <input type="checkbox"/>	
<input type="radio"/> Signature:	

<input type="radio"/> Repair Order #:	Dealer stamp
<input type="radio"/> Distance:	
<input type="radio"/> Engine hours (optional):	
<input type="radio"/> Multi-point inspection (recommended): <input type="checkbox"/>	
<input type="radio"/> Signature:	

Scheduled Maintenance

<input type="radio"/> Repair Order #:	<p>Dealer stamp</p>
<input type="radio"/> Distance:	
<input type="radio"/> Engine hours (optional):	
<input type="radio"/> Multi-point inspection (recommended): <input type="checkbox"/>	
<input type="radio"/> Signature:	

<input type="radio"/> Repair Order #:	<p>Dealer stamp</p>
<input type="radio"/> Distance:	
<input type="radio"/> Engine hours (optional):	
<input type="radio"/> Multi-point inspection (recommended): <input type="checkbox"/>	
<input type="radio"/> Signature:	

Scheduled Maintenance

<input type="radio"/> Repair Order #:	<p>Dealer stamp</p>
<input type="radio"/> Distance:	
<input type="radio"/> Engine hours (optional):	
<input type="radio"/> Multi-point inspection (recommended): <input type="checkbox"/>	
<input type="radio"/> Signature:	

<input type="radio"/> Repair Order #:	<p>Dealer stamp</p>
<input type="radio"/> Distance:	
<input type="radio"/> Engine hours (optional):	
<input type="radio"/> Multi-point inspection (recommended): <input type="checkbox"/>	
<input type="radio"/> Signature:	

Scheduled Maintenance

<input type="radio"/> Repair Order #:	<p>Dealer stamp</p>
<input type="radio"/> Distance:	
<input type="radio"/> Engine hours (optional):	
<input type="radio"/> Multi-point inspection (recommended): <input type="checkbox"/>	
<input type="radio"/> Signature:	

<input type="radio"/> Repair Order #:	<p>Dealer stamp</p>
<input type="radio"/> Distance:	
<input type="radio"/> Engine hours (optional):	
<input type="radio"/> Multi-point inspection (recommended): <input type="checkbox"/>	
<input type="radio"/> Signature:	

Scheduled Maintenance

<input type="radio"/> Repair Order #:	Dealer stamp
<input type="radio"/> Distance:	
<input type="radio"/> Engine hours (optional):	
<input type="radio"/> Multi-point inspection (recommended): <input type="checkbox"/>	
<input type="radio"/> Signature:	

<input type="radio"/> Repair Order #:	Dealer stamp
<input type="radio"/> Distance:	
<input type="radio"/> Engine hours (optional):	
<input type="radio"/> Multi-point inspection (recommended): <input type="checkbox"/>	
<input type="radio"/> Signature:	

Scheduled Maintenance

<input type="radio"/> Repair Order #:	Dealer stamp
<input type="radio"/> Distance:	
<input type="radio"/> Engine hours (optional):	
<input type="radio"/> Multi-point inspection (recommended): <input type="checkbox"/>	
<input type="radio"/> Signature:	

<input type="radio"/> Repair Order #:	Dealer stamp
<input type="radio"/> Distance:	
<input type="radio"/> Engine hours (optional):	
<input type="radio"/> Multi-point inspection (recommended): <input type="checkbox"/>	
<input type="radio"/> Signature:	

Scheduled Maintenance

<input type="radio"/> Repair Order #:	Dealer stamp
<input type="radio"/> Distance:	
<input type="radio"/> Engine hours (optional):	
<input type="radio"/> Multi-point inspection (recommended): <input type="checkbox"/>	
<input type="radio"/> Signature:	

<input type="radio"/> Repair Order #:	Dealer stamp
<input type="radio"/> Distance:	
<input type="radio"/> Engine hours (optional):	
<input type="radio"/> Multi-point inspection (recommended): <input type="checkbox"/>	
<input type="radio"/> Signature:	

Appendices

END USER LICENSE AGREEMENT

VEHICLE SOFTWARE END USER LICENSE AGREEMENT (EULA)

- You ("You" or "Your" as applicable) have acquired a vehicle having several devices, including SYNC ® and various control modules, ("DEVICES") that include software licensed or owned by Ford Motor Company and its affiliates ("FORD MOTOR COMPANY"). Those software products of FORD MOTOR COMPANY origin, as well as associated media, printed materials, and "online" or electronic documentation ("SOFTWARE") are protected by international intellectual property laws and treaties. The SOFTWARE is licensed, not sold. All rights reserved.
- The SOFTWARE may interface with and/or communicate with, or may be later upgraded to interface with and/or communicate with additional software and/or systems provided by FORD MOTOR COMPANY.

IF YOU DO NOT AGREE TO THIS END USER LICENSE AGREEMENT ("EULA") DO NOT USE THE DEVICES OR COPY THE SOFTWARE. ANY USE OF THE SOFTWARE, INCLUDING BUT NOT LIMITED TO USE ON THE DEVICES, WILL CONSTITUTE YOUR AGREEMENT TO THIS EULA (OR RATIFICATION OF ANY PREVIOUS CONSENT).

GRANT OF SOFTWARE LICENSE: This EULA grants you the following license:

- You may use the SOFTWARE as installed on the DEVICES and as otherwise interfacing with systems and/or services provide by or through FORD MOTOR COMPANY or its third party software and service providers.

Description of Other Rights and Limitations

- **Speech Recognition:** If the SOFTWARE includes speech recognition component(s), you should understand that speech recognition is an inherently statistical process and that recognition errors are inherent in the process. Neither FORD MOTOR COMPANY nor its suppliers shall be liable for any damages arising out of errors in the speech recognition process. It is your responsibility to monitor any speech recognition functions included in the system.
- **Limitations on Reverse Engineering, Decompilation and Disassembly:** You may not reverse engineer, decompile, translate, disassemble or attempt to discover any source code or underlying ideas or algorithms of the SOFTWARE nor permit others to reverse engineer, decompile or disassemble the SOFTWARE, except and only to the extent that such activity is expressly permitted by applicable law notwithstanding this limitation or to the extent as may be permitted by the licensing terms governing use of any open source components included with the SOFTWARE.
- **Limitations on Distributing, Copying, Modifying and Creating Derivative Works:** You may not distribute, copy, make modifications to or create derivative works based on the SOFTWARE, except and only to the extent that such activity is expressly permitted by applicable law notwithstanding this limitation or to the extent as may be permitted by the licensing terms governing use of any open source components included with the SOFTWARE.

Appendices

- **Single EULA:** The end user documentation for the DEVICES and related systems and services may contain multiple EULAs, such as multiple translations and/or multiple media versions (e.g., in the user documentation and in the software). Even if you receive multiple EULAs, you are licensed to use only one (1) copy of the SOFTWARE.
- **SOFTWARE Transfer:** You may permanently transfer your rights under this EULA only as part of a sale or transfer of the DEVICES, provided you retain no copies, you transfer all of the SOFTWARE (including all component parts, the media and printed materials, any upgrades, and, if applicable, the Certificate(s) of Authenticity), and the recipient agrees to the terms of this EULA. If the SOFTWARE is an upgrade, any transfer must include all prior versions of the SOFTWARE.
- **Termination:** Without prejudice to any other rights, FORD MOTOR COMPANY may terminate this EULA if you fail to comply with the terms and conditions of this EULA.
- **Internet-Based Services Components:** The SOFTWARE may contain components that enable and facilitate the use of certain Internet-based services. You acknowledge and agree that FORD MOTOR COMPANY, third party software and service suppliers, its affiliates and/or its designated agent may automatically check the version of the SOFTWARE and/or its components that you are utilizing and may provide upgrades or supplements to the SOFTWARE that may be automatically downloaded to your DEVICES.
- **Additional Software/Services:** The SOFTWARE may permit FORD MOTOR COMPANY, third party software and service suppliers, its affiliates and/or its designated agent to provide or make available to you SOFTWARE updates, supplements, add-on components, or Internet-based services components of the SOFTWARE after the date you obtain your initial copy of the SOFTWARE ("Supplemental Components".) SOFTWARE updates may cause you to incur additional charges from your wireless service provider. If FORD MOTOR COMPANY or third party software and services suppliers provide or make available to you Supplemental Components and no other EULA terms are provided along with the Supplemental Components, then the terms of this EULA shall apply. FORD MOTOR COMPANY, its affiliates and/or its designated agent reserve the right to discontinue without liability any Internet-based services provided to you or made available to you through the use of the SOFTWARE.

Appendices

- **Links to Third Party Sites:** The SOFTWARE may provide you with the ability to link to third party sites. The third party sites are not under the control of FORD MOTOR COMPANY, its affiliates and/or its designated agent. Neither FORD MOTOR COMPANY nor its affiliates nor its designated agent are responsible for (i) the contents of any third party sites, any links contained in third party sites, or any changes or updates to third party sites, or (ii) webcasting or any other form of transmission received from any third party sites. If the SOFTWARE provides links to third party sites, those links are provided to you only as a convenience, and the inclusion of any link does not imply an endorsement of the third party site by FORD MOTOR COMPANY, its affiliates and/or its designated agent.
- **Obligation to Drive Responsibly:** You recognize your obligation to drive responsibly and keep attention on the road. You will read and abide with the DEVICES operating instructions particularly as they pertain to safety and you agree to assume any risk associated with the use of the DEVICES.

UPGRADES AND RECOVERY MEDIA:

If the SOFTWARE is provided by FORD MOTOR COMPANY separate from the DEVICES on media such as a ROM chip, CD ROM disk(s) or via web download or other means, and is labeled "For Upgrade Purposes Only" or "For Recovery Purposes Only" you may install one (1) copy of such SOFTWARE onto the DEVICES as a replacement copy for the existing SOFTWARE, and use it in accordance with this EULA, including any additional EULA terms accompanying the upgrade SOFTWARE.

INTELLECTUAL PROPERTY RIGHTS:

All title and intellectual property rights in and to the SOFTWARE (including but not limited to any images, photographs, animations, video, audio, music, text and "applets" incorporated into the SOFTWARE), the accompanying printed materials, and any copies of the SOFTWARE, are owned by FORD MOTOR COMPANY, or its affiliates or suppliers. The SOFTWARE is licensed, not sold. You may not copy the printed materials accompanying the SOFTWARE. All title and intellectual property rights in and to the content which may be accessed through use of the SOFTWARE is the property of the respective content owner and may be protected by applicable copyright or other intellectual property laws and treaties. This EULA grants you no rights to use such content outside its intended use. All rights not specifically granted under this EULA are reserved by FORD MOTOR COMPANY, its affiliates, and third party software and service providers and suppliers. Use of any on-line services which may be accessed through the SOFTWARE may be governed by the respective terms of use relating to such services. If this SOFTWARE contains documentation that is provided only in electronic form, you may print one copy of such electronic documentation.

EXPORT RESTRICTIONS: You acknowledge that the SOFTWARE is subject to U.S. and European Union export jurisdiction. You agree to comply with all applicable international and national laws that apply to the SOFTWARE, including the U.S. Export Administration Regulations, as well as end-user, end-use and destination restrictions issued by U.S. and other governments.

Appendices

TRADEMARKS: This EULA does not grant you any rights in connection with any trademarks or service marks of FORD MOTOR COMPANY, its affiliates, and third party software and service providers.

PRODUCT SUPPORT: Please refer to FORD MOTOR COMPANY instructions provided in the documentation for the DEVICES product support, such as the vehicle owner guide.

Should you have any questions concerning this EULA, or if you desire to contact FORD MOTOR COMPANY for any other reason, please refer to the address provided in the documentation for the DEVICES.

No Liability for Certain Damages: EXCEPT AS PROHIBITED BY LAW, FORD MOTOR COMPANY, ANY THIRD PARTY SOFTWARE OR SERVICES SUPPLIERS, AND THEIR AFFILIATES SHALL HAVE NO LIABILITY FOR ANY INDIRECT, SPECIAL, CONSEQUENTIAL OR INCIDENTAL DAMAGES ARISING FROM OR IN CONNECTION WITH THE USE OR PERFORMANCE OF THE SOFTWARE. THIS LIMITATION SHALL APPLY EVEN IF ANY REMEDY FAILS OF ITS ESSENTIAL PURPOSE. THERE ARE NO WARRANTIES OTHER THAN THOSE THAT MAY BE EXPRESSLY PROVIDED FOR YOUR NEW VEHICLE.

SYNC® Automotive Important Safety Information Read and follow instructions:

- Before using your SYNC® system, read and follow all instructions and safety information provided in this end user manual ("Owner Guide".) Not following precautions found in the Owner Guide can lead to an accident or other serious injuries.

General Operation

- **Voice Command Control:** Certain functions within the SYNC® system may be accomplished using voice commands. Using voice commands while driving helps you to operate the system without removing your hands from the wheel or eyes from the road.
- **Prolonged Views of Screen:** Do not access any function requiring a prolonged view of the screen while you are driving. Pull over in a safe and legal manner before attempting to access a function of the system requiring prolonged attention.
- **Volume Setting:** Do not raise the volume excessively. Keep the volume at a level where you can still hear outside traffic and emergency signals while driving. Driving while unable to hear these sounds could cause an accident.
- **Navigation Features:** Any navigation features included in the system are intended to provide turn by turn instructions to get you to a desired destination. Please make certain all persons using this system carefully read and follow instructions and safety information fully.
- **Distraction Hazard:** Any navigation features may require manual (non-verbal) setup. Attempting to perform such set-up or insert data while driving can distract your attention and could cause an accident or other serious injury. Stop the vehicle in a safe and legal manner before attempting these operations.
- **Let Your Judgment Prevail:** Any navigation features are provided only as an aid. Make your driving decisions based on your observations of local conditions and existing traffic regulations. Any such feature is not a

Appendices

substitute for your personal judgment. Any route suggestions made by this system should never replace any local traffic regulations or your personal judgment or knowledge of safe driving practices.

- **Route Safety:** Do not follow the route suggestions if doing so would result in an unsafe or illegal maneuver, if you would be placed in an unsafe situation, or if you would be directed into an area that you consider unsafe. The driver is ultimately responsible for the safe operation of the vehicle and therefore, must evaluate whether it is safe to follow the suggested directions.
- **Potential Map Inaccuracy:** Maps used by this system may be inaccurate because of changes in roads, traffic controls or driving conditions. Always use good judgment and common sense when following the suggested routes.
- **Emergency Services:** Do not rely on any navigation features included in the system to route you to emergency services. Ask local authorities or an emergency services operator for these locations. Not all emergency services such as police, fire stations, hospitals and clinics are likely to be contained in the map database for such navigation features.

Your Responsibilities and Assumptions of Risk

- You agree to each of the following:(a) Any use of the SOFTWARE while driving an automobile or other vehicle in violation of applicable law or otherwise driving in an unsafe manner presents a significant risk of distracted driving and should not be attempted under any circumstances;(b) Use of the SOFTWARE at excessive volume poses a significant risk of hearing damage and should not be attempted under any circumstances;(c) The SOFTWARE may not be compatible with new or different versions of an operating system, third party software, or third party services, and the SOFTWARE may potentially cause a critical failure of an operating system, third party software, or third party service.(d) Any third party service accessed by or third party software used with the SOFTWARE (i) may charge an additional fee for access, (ii) may not work correctly, on an uninterrupted basis, or error free, (iii) may change streaming formats or discontinue operation, (iv) may contain adult, profane or offensive content; and (v) may contain inaccurate, false or misleading traffic, weather, financial or safety information or other content; and (e) Use of the SOFTWARE may cause you to incur additional charges from your wireless service provider (WSP) and any data or minute calculators that may be included in the software program are for reference only, are not warranted in any way and should not be relied upon in anyway.
- When using the SOFTWARE, you agree to be responsible for and assume the entire risk to the items set forth in Section (a) – (e) above.

Appendices

Disclaimer of Warranty

YOU EXPRESSLY ACKNOWLEDGE AND AGREE THAT USE OF THE DEVICES AND SOFTWARE IS AT YOUR SOLE RISK AND THAT THE ENTIRE RISK AS TO SATISFACTORY QUALITY, PERFORMANCE, COMPATIBILITY, ACCURACY AND EFFORT IS WITH YOU. TO THE MAXIMUM EXTENT PERMITTED BY APPLICABLE LAW, THE SOFTWARE AND ANY THIRD PARTY SOFTWARE OR THIRD-PARTY SERVICES ARE PROVIDED "AS IS" AND "AS AVAILABLE", WITH ALL FAULTS AND WITHOUT WARRANTY OF ANY KIND, AND FORD MOTOR COMPANY HEREBY DISCLAIMS ALL WARRANTIES AND CONDITIONS WITH RESPECT TO THE SOFTWARE, THIRD PARTY SOFTWARE, AND THIRD-PARTY SERVICES, EITHER EXPRESS, IMPLIED OR STATUTORY, INCLUDING, BUT NOT LIMITED TO, THE IMPLIED WARRANTIES AND/OR CONDITIONS OF MERCHANTABILITY, OF SATISFACTORY QUALITY, OF FITNESS FOR AN PARTICULAR PURPOSE, OF ACCURACY, OF QUIET ENJOYMENT, AND NON-INFRINGEMENT OF THIRD-PARTY RIGHTS. FORD MOTOR COMPANY DOES NOT WARRANT (a) AGAINST INTERFERENCE WITH YOUR ENJOYMENT OF THE SOFTWARE, THIRD PARTY SOFTWARE, OR THIRD-PARTY SERVICES, (b) THAT THE SOFTWARE, THIRD PARTY SOFTWARE, OR THIRD-PARTY SERVICES WILL MEET YOUR REQUIREMENTS, (c) THAT THE OPERATION OF THE SOFTWARE, THIRD PARTY SOFTWARE, OR THIRD-PARTY SERVICES WILL BE UNINTERRUPTED OR ERROR-FREE, (d) OR THAT DEFECTS IN THE SOFTWARE, THIRD PARTY SOFTWARE, OR THIRD-PARTY SERVICES WILL BE CORRECTED. NO ORAL OR WRITTEN INFORMATION OR ADVICE GIVEN BY FORD MOTOR COMPANY OR ITS AUTHORIZED REPRESENTATIVE SHALL

CREATE A WARRANTY. SHOULD THE SOFTWARE, THIRD PARTY SOFTWARE, OR THIRD-PARTY SERVICES PROVE DEFECTIVE, YOU ASSUME THE ENTIRE COST OF ALL NECESSARY SERVICING, REPAIR OR CORRECTION. SOME JURISDICTIONS DO NOT ALLOW THE DISCLAIMER OF IMPLIED WARRANTIES OR LIMITATIONS ON APPLICABLE STATUTORY RIGHTS OF A CONSUMER, SO THE ABOVE DISCLAIMER MAY NOT FULLY APPLY TO YOU. THE SOLE WARRANTY PROVIDED BY FORD MOTOR COMPANY SHALL BE FOUND IN THE WARRANTY INFORMATION INCLUDING WITH YOUR OWNER GUIDE. TO THE EXTENT THAT THERE IS ANY CONFLICT BETWEEN THE TERMS OF THIS SECTION AND THE WARRANTY BOOKLET, THE WARRANTY BOOKLET SHALL CONTROL.

Applicable Law, Venue, Jurisdiction

- The laws of the State of Michigan govern this EULA and Your use of the SOFTWARE. Your use of the SOFTWARE may also be subject to other local, state, national, or international laws. Any litigation arising out of or related to this EULA shall be brought and maintained exclusively in a court of the State of Michigan located in Wayne County or in the United States District Court for the Eastern District of Michigan. You hereby consent to submit to the personal jurisdiction of a court in the State of Michigan located in Wayne County and the United States District Court for the Eastern District of Michigan for any dispute arising out of or relating to this EULA.

Appendices

Binding Arbitration and Class Action Waiver

(a) Application. This Section applies to any dispute EXCEPT IT DOES NOT INCLUDE A DISPUTE RELATING TO COPYRIGHT INFRINGEMENT, OR TO THE ENFORCEMENT OR VALIDITY OF YOUR, FORD MOTOR COMPANY, OR ANY OF FORD MOTOR COMPANY'S LICENSORS' INTELLECTUAL PROPERTY RIGHTS. Dispute means any dispute, action, or other controversy between You and FORD MOTOR COMPANY, other than the exceptions listed above, concerning the SOFTWARE (including its price) or this EULA, whether in contract, warranty, tort, statute, regulation, ordinance, or any other legal or equitable basis.

(b) Notice of Dispute. In the event of a Dispute, You or FORD MOTOR COMPANY must give the other a "Notice of Dispute", which is a written statement of the name, address, and contact information of the party giving it, the facts giving rise to the dispute, and the relief requested. You and FORD MOTOR COMPANY will attempt to resolve any dispute through informal negotiation within 60 days from the date the Notice of Dispute is sent. After 60 days, You or FORD MOTOR COMPANY may commence arbitration.

(c) Small claims court. You may also litigate any dispute in small claims court in your county of residence or FORD MOTOR COMPANY'S principal place of business, if the dispute meets all requirements to be heard in the small claims court. You may litigate in small claims court whether or not You negotiated informally first.

(d) Binding arbitration. If You and FORD MOTOR COMPANY, do not resolve any dispute by informal negotiation or in small claims court, any other effort to resolve the dispute will be conducted exclusively by binding arbitration. You are giving up

the right to litigate (or participate in as a party or class member) all disputes in court before a judge or jury. Instead, all disputes will be resolved before a neutral arbitrator, whose decision will be final except for a limited right of appeal under the Federal Arbitration Act. Any court with jurisdiction over the parties may enforce the arbitrator's award.

(e) Class action waiver. Any proceedings to resolve or litigate any dispute in any forum will be conducted solely on an individual basis. Neither you nor FORD MOTOR COMPANY, will seek to have any dispute heard as a class action, as a private attorney general action, or in any other proceeding in which any party acts or proposes to act in a representative capacity. No arbitration or proceeding will be combined with another without the prior written consent of all parties to all affected arbitrations or proceedings.

(f) Arbitration procedure. Any arbitration will be conducted by the American Arbitration Association (the "AAA"), under its Commercial Arbitration Rules. If You are an individual and use the SOFTWARE for personal or vehicle use, or if the value of the dispute is \$75,000 or less whether or not You are an individual or how You use the SOFTWARE, the AAA Supplementary Procedures for Consumer-Related Disputes will also apply. To commence arbitration, submit a Commercial Arbitration Rules Demand for Arbitration form to the AAA. You may request a telephonic or in-person hearing by following the AAA rules. In a dispute involving \$10,000 or less, any hearing will be telephonic unless the arbitrator finds good cause to hold an in-person hearing instead. For more information, see adr.org or call 1-800-778-7879. You agree to commence arbitration only in your county of residence or FORD MOTOR COMPANY'S principal place of business. The arbitrator

Appendices

may award the same damages to You individually as a court could. The arbitrator may award declaratory or injunctive relief only to You individually, and only to the extent required to satisfy Your individual claim.

(g) Arbitration fees and incentives.

- I. Disputes involving \$75,000 or less. FORD MOTOR COMPANY will promptly reimburse your filing fees and pay the AAA's and arbitrator's fees and expenses. If you reject FORD MOTOR COMPANY'S last written settlement offer made before the arbitrator was appointed ("last written offer"), your dispute goes all the way to an arbitrator's decision (called an "award"), and the arbitrator awards you more than the last written offer, FORD MOTOR COMPANY will give you three incentives: (1) pay the greater of the award or \$1,000; (2) pay twice your reasonable attorney's fees, if any; and (3) reimburse any expenses (including expert witness fees and costs) that your attorney reasonably accrues for investigating, preparing, and pursuing your claim in arbitration. The arbitrator will determine the amounts.
- ii. Disputes involving more than \$75,000. The AAA rules will govern payment of filing fees and the AAA's and arbitrator's fees and expenses.
- iii. Disputes involving any amount. In any arbitration you commence, FORD MOTOR COMPANY will seek its AAA or arbitrator's fees and expenses, or Your filing fees it reimbursed, only if the arbitrator finds the arbitration frivolous or brought for an improper purpose. In any arbitration FORD MOTOR COMPANY commences, it will pay all

filing, AAA, and arbitrator's fees and expenses. It will not seek its attorney's fees or expenses from you in any arbitration. Fees and expenses are not counted in determining how much a dispute involves.

(h) Claims or disputes must be filed within one year. To the extent permitted by law, any claim or dispute under this EULA to which this Section applies must be filed within one year in small claims court (Section c) or in arbitration (Section d). The one-year period begins when the claim or dispute first could be filed. If such a claim or dispute is not filed within one year, it is permanently barred.

(i) Severability. If the class action waiver (Section e) is found to be illegal or unenforceable as to all or some parts of a dispute, then that portion of Section e will not apply to those parts. Instead, those parts will be severed and proceed in a court of law, with the remaining parts proceeding in arbitration. If any other provision of that portion Section e is found to be illegal or unenforceable, that provision will be severed with the remainder of Section e remaining in full force and effect.

Telenav Software End User License Agreement

Please read these terms and conditions carefully before you use the TeleNav Software. Your use of the TeleNav Software indicates that you accept these terms and conditions. If you do not accept these terms and conditions, do not break the seal of the package, launch, or otherwise use the TeleNav Software. TeleNav may revise this Agreement and the privacy policy at any time, with or without notice to you. You agree to visit <http://www.telenav.com> from time to time to review the then current version of this Agreement and of the privacy policy.

Appendices

1. Safe and Lawful Use

You acknowledge that devoting attention to the TeleNav Software may pose a risk of injury or death to you and others in situations that otherwise require your undivided attention, and you therefore agree to comply with the following when using the TeleNav Software:

- (a) observe all traffic laws and otherwise drive safely;
- (b) use your own personal judgment while driving. If you feel that a route suggested by the TeleNav Software instructs you to perform an unsafe or illegal maneuver, places you in an unsafe situation, or directs you into an area that you consider to be unsafe, do not follow such instructions;
- (c) do not input destinations, or otherwise manipulate the TeleNav Software, unless your vehicle is stationary and parked;
- (d) do not use the TeleNav Software for any illegal, unauthorized, unintended, unsafe, hazardous, or unlawful purposes, or in any manner inconsistent with this Agreement;
- (e) arrange all GPS and wireless devices and cables necessary for use of the TeleNav Software in a secure manner in your vehicle so that they will not interfere with your driving and will not prevent the operation of any safety device (such as an airbag).

You agree to indemnify and hold TeleNav harmless against all claims resulting from any dangerous or otherwise inappropriate use of the TeleNav Software in any moving vehicle, including as a result of your failure to comply with the directions above.

2. Account Information

You agree: (a) when registering the TeleNav Software, to provide TeleNav with true, accurate, current, and complete information about yourself, and (b) to inform TeleNav promptly of any changes to such information, and to keep it true, accurate, current and complete.

3. Software License

- Subject to your compliance with the terms of this Agreement, TeleNav hereby grants to you a personal, non-exclusive, non-transferable license (except as expressly permitted below in connection with your permanent transfer of the TeleNav Software license), without the right to sublicense, to use the TeleNav Software (in object code form only) in order to access and use the TeleNav Software. This license shall terminate upon any termination or expiration of this Agreement. You agree that you will use the TeleNav Software only for your personal business or leisure purposes, and not to provide commercial navigation services to other parties.

3.1 License Limitations

- **(a)** reverse engineer, decompile, disassemble, translate, modify, alter or otherwise change the TeleNav Software or any part thereof; **(b)** attempt to derive the source code, audio library or structure of the TeleNav Software without the prior express written consent of TeleNav; **(c)** remove from the TeleNav Software, or alter, any of TeleNav's or its suppliers' trademarks, trade names, logos, patent or copyright notices, or other notices or markings; **(d)**

Appendices

distribute, sublicense or otherwise transfer the TeleNav Software to others, except as part of your permanent transfer of the TeleNav Software; or **(e)** use the TeleNav Software in any manner that

- i. infringes the intellectual property or proprietary rights, rights of publicity or privacy or other rights of any party,
- ii. violates any law, statute, ordinance or regulation, including but not limited to laws and regulations related to spamming, privacy, consumer and child protection, obscenity or defamation, or
- iii. is harmful, threatening, abusive, harassing, tortuous, defamatory, vulgar, obscene, libelous, or otherwise objectionable; and (f) lease, rent out, or otherwise permit unauthorized access by third parties to the TeleNav Software without advanced written permission of TeleNav.

4. Disclaimers

- To the fullest extent permissible pursuant to applicable law, in no event will TeleNav, its licensors and suppliers, or agents or employees of any of the foregoing, be liable for any decision made or action taken by you or anyone else in reliance on the information provided by the TeleNav Software. TeleNav also does not warrant the accuracy of the map or other data used for the TeleNav Software. Such data may not always reflect reality due to, among other things, road closures, construction, weather, new roads and other changing conditions. You are responsible for the entire risk arising out of your use of the TeleNav Software. For example but without limitation, you agree not to rely on the TeleNav Software for critical navigation in areas where the well-being or survival of you or others

is dependent on the accuracy of navigation, as the maps or functionality of the TeleNav Software are not intended to support such high risk applications, especially in more remote geographical areas.

- TELENAV EXPRESSLY DISCLAIMS AND EXCLUDES ALL WARRANTIES IN CONNECTION WITH THE TELENAV SOFTWARE, WHETHER STATUTORY, EXPRESS OR IMPLIED, INCLUDING ALL WARRANTIES WHICH MAY ARISE FROM COURSE OF DEALING, CUSTOM OR TRADE AND INCLUDING, BUT NOT LIMITED TO, THE IMPLIED WARRANTIES OF MERCHANTABILITY, FITNESS FOR A PARTICULAR PURPOSE AND NON-INFRINGEMENT OF THIRD PARTY RIGHTS WITH RESPECT TO THE TELENAV SOFTWARE.
- Certain jurisdictions do not permit the disclaimer of certain warranties, so this limitation may not apply to you.

5. Limitation of Liability

- TO THE EXTENT PERMITTED UNDER APPLICABLE LAW, UNDER NO CIRCUMSTANCES SHALL TELENAV OR ITS LICENSORS AND SUPPLIERS BE LIABLE TO YOU OR TO ANY THIRD PARTY FOR ANY INDIRECT, INCIDENTAL, CONSEQUENTIAL, SPECIAL OR EXEMPLARY DAMAGES (INCLUDING IN EACH CASE, BUT NOT LIMITED TO, DAMAGES FOR THE INABILITY TO USE THE EQUIPMENT OR ACCESS DATA, LOSS OF DATA, LOSS OF BUSINESS, LOSS OF PROFITS, BUSINESS INTERRUPTION OR THE LIKE) ARISING OUT OF THE USE OF OR INABILITY TO USE THE TELENAV SOFTWARE, EVEN IF TELENAV HAS BEEN ADVISED OF THE POSSIBILITY OF SUCH DAMAGES. NOTWITHSTANDING ANY DAMAGES THAT YOU MIGHT INCUR FOR ANY

Appendices

REASON WHATSOEVER (INCLUDING, WITHOUT LIMITATION, ALL DAMAGES REFERENCED HEREIN AND ALL DIRECT OR GENERAL DAMAGES IN CONTRACT, TORT (INCLUDING NEGLIGENCE) OR OTHERWISE), THE ENTIRE LIABILITY OF TELENAV AND OF ALL OF TELENAV'S SUPPLIERS SHALL BE LIMITED TO THE AMOUNT ACTUALLY PAID BY YOU FOR THE TELENAV SOFTWARE. SOME STATES AND/OR JURISDICTIONS DO NOT ALLOW THE EXCLUSION OR LIMITATION OF INCIDENTAL OR CONSEQUENTIAL DAMAGES, SO THE ABOVE LIMITATIONS OR EXCLUSIONS MAY NOT APPLY TO YOU.

6. Arbitration and Governing Law

- You agree that any dispute, claim or controversy arising out of or relating to this Agreement or the TeleNav Software shall be settled by independent arbitration involving a neutral arbitrator and administered by the American Arbitration Association in the County of Santa Clara, California. The arbitrator shall apply the Commercial Arbitration Rules of the American Arbitration Association, and the judgment upon the award rendered by the arbitrator may be entered by any court having jurisdiction. Note that there is no judge or jury in an arbitration proceeding and the decision of the arbitrator shall be binding upon both parties. You expressly agree to waive your right to a jury trial. This Agreement and performance hereunder will be governed by and construed in accordance with the laws of the State of California, without giving effect to its conflict of law provisions. To the extent judicial action is necessary in connection with the binding arbitration, both TeleNav and you agree to submit

to the exclusive jurisdiction of the courts of the County of Santa Clara, California. The United Nations Convention on Contracts for the International Sale of Goods shall not apply.

7. Assignment

- You may not resell, assign, or transfer this Agreement or any of your rights or obligations, except in totality, in connection with your permanent transfer of the TeleNav Software, and expressly conditioned upon the new user of the TeleNav Software agreeing to be bound by the terms and conditions of this Agreement. Any such sale, assignment or transfer that is not expressly permitted under this paragraph will result in immediate termination of this Agreement, without liability to TeleNav, in which case you and all other parties shall immediately cease all use of the TeleNav Software. Notwithstanding the foregoing, TeleNav may assign this Agreement to any other party at any time without notice, provided the assignee remains bound by this Agreement.

8. Miscellaneous

8.1

This Agreement constitutes the entire agreement between TeleNav and you with respect to the subject matter hereof.

8.2

Except for the limited licenses expressly granted in this Agreement, TeleNav retains all right, title and interest in and to the TeleNav Software, including without limitation all related intellectual property rights. No licenses or other rights which are not expressly granted in this Agreement are intended to, or shall be, granted or

Appendices

conferred by implication, statute, inducement, estoppel or otherwise, and TeleNav and its suppliers and licensors hereby reserve all of their respective rights other than the licenses explicitly granted in this Agreement.

8.3

By using the TeleNav Software, you consent to receive from TeleNav all communications, including notices, agreements, legally required disclosures or other information in connection with the TeleNav Software (collectively, "Notices") electronically. TeleNav may provide such Notices by posting them on TeleNav's Website or by downloading such Notices to your wireless device. If you desire to withdraw your consent to receive Notices electronically, you must discontinue your use of the TeleNav Software.

8.4

TeleNav's or your failure to require performance of any provision shall not affect that party's right to require performance at any time thereafter, nor shall a waiver of any breach or default of this Agreement constitute a waiver of any subsequent breach or default or a waiver of the provision itself.

8.5

If any provision herein is held unenforceable, then such provision will be modified to reflect the intention of the parties, and the remaining provisions of this Agreement will remain in full force and effect.

8.6

The headings in this Agreement are for convenience of reference only, will not be deemed to be a part of this Agreement, and will not be referred to in connection with the construction or interpretation of this Agreement. As used in this Agreement, the words "include" and "including" and variations thereof, will not be deemed to be terms of limitation, but rather will be deemed to be followed by the words "without limitation".

9. Other Vendors Terms and Conditions

- The Telenav Software utilizes map and other data licensed to Telenav by third party vendors for the benefit of you and other end users. This Agreement includes end-user terms applicable to these companies (included at the end of this Agreement), and thus your use of the Telenav Software is also subject to such terms. You agree to comply with the following additional terms and conditions, which are applicable to Telenav's third party vendor licensors::

9.1 End User Terms Required by HERE North America, LLC

The data ("Data") is provided for your personal, internal use only and not for resale. It is protected by copyright, and is subject to the following terms and conditions which are agreed to by you, on the one hand, and Telenav ("Telenav") and its licensors (including their licensors and suppliers) on the other hand.

© 2013 HERE. All rights reserved.

The Data for areas of Canada includes information taken with permission from Canadian authorities, including: © Her Majesty the Queen in Right of Canada, © Queen's Printer for Ontario, © Canada Post Corporation, GeoBase®, © Department of Natural Resources Canada.

Appendices

HERE holds a non-exclusive license from the United States Postal Service® to publish and sell ZIP+4® information.

©United States Postal Service® 2014. Prices are not established, controlled or approved by the United States Postal Service®. The following trademarks and registrations are owned by the USPS: United States Postal Service, USPS, and ZIP+4

The Data for Mexico includes certain data from Instituto Nacional de Estadística y Geografía.

9.2 End User Terms Required by NAV2 (Shanghai) Co., Ltd

The data (“Data”) is provided for your personal, internal use only and not for resale. It is protected by copyright, and is subject to the following terms and conditions which are agreed to by you, on the one hand, and NAV2 (Shanghai) Co., Ltd (“NAV2”) and its licensors (including their licensors and suppliers) on the other hand. 20xx. All rights reserved

Terms and Conditions

Permitted Use. You agree to use this Data together with the Telenav Software solely for the internal business and personal purposes for which you were licensed, and not for service bureau, time-sharing or other similar purposes. Accordingly, but subject to the restrictions set forth in the following paragraphs, you agree not to otherwise reproduce, copy, modify, decompile, disassemble, create any derivative works of, or reverse engineer any portion of this Data, and may not transfer or distribute it in any form, for any purpose, except to the extent permitted by mandatory laws.

Restrictions. Except where you have been specifically licensed to do so by Telenav, and without limiting the preceding paragraph, you may not use this Data (a) with any products, systems, or applications installed or otherwise connected to or in communication with vehicles, capable of vehicle navigation, positioning, dispatch, real time route guidance, fleet management or similar applications; or (b) with or in communication with any positioning devices or any mobile or wireless-connected electronic or computer devices, including without limitation cellular phones, palmtop and handheld computers, pagers, and personal digital assistants or PDAs.

Warning. The Data may contain inaccurate or incomplete information due to the passage of time, changing circumstances, sources used and the nature of collecting comprehensive geographic data, any of which may lead to incorrect results.

No Warranty. This Data is provided to you “as is,” and you agree to use it at your own risk. Telenav and its licensors (and their licensors and suppliers) make no guarantees, representations or warranties of any kind, express or implied, arising by law or otherwise, including but not limited to, content, quality, accuracy, completeness, effectiveness, reliability, fitness for a particular purpose, usefulness, use or results to be obtained from this Data, or that the Data or server will be uninterrupted or error-free.

Disclaimer of Warranty: TELENAV AND ITS LICENSORS (INCLUDING THEIR LICENSORS AND SUPPLIERS) DISCLAIM ANY WARRANTIES, EXPRESS OR IMPLIED, OF QUALITY, PERFORMANCE, MERCHANTABILITY, FITNESS FOR A

Appendices

PARTICULAR PURPOSE OR NON-INFRINGEMENT. Some States, Territories and Countries do not allow certain warranty exclusions, so to that extent the above exclusion may not apply to you.

Disclaimer of Liability: TELENV AND ITS LICENSORS (INCLUDING THEIR LICENSORS AND SUPPLIERS) SHALL NOT BE LIABLE TO YOU: IN RESPECT OF ANY CLAIM, DEMAND OR ACTION, IRRESPECTIVE OF THE NATURE OF THE CAUSE OF THE CLAIM, DEMAND OR ACTION ALLEGING ANY LOSS, INJURY OR DAMAGES, DIRECT OR INDIRECT, WHICH MAY RESULT FROM THE USE OR POSSESSION OF THE INFORMATION; OR FOR ANY LOSS OF PROFIT, REVENUE, CONTRACTS OR SAVINGS, OR ANY OTHER DIRECT, INDIRECT, INCIDENTAL, SPECIAL OR CONSEQUENTIAL DAMAGES ARISING OUT OF YOUR USE OF OR INABILITY TO USE THIS INFORMATION, ANY DEFECT IN THE INFORMATION, OR THE BREACH OF THESE TERMS OR CONDITIONS, WHETHER IN AN ACTION IN CONTRACT OR TORT OR BASED ON A WARRANTY, EVEN IF TELENV OR ITS LICENSORS HAVE BEEN ADVISED OF THE POSSIBILITY OF SUCH DAMAGES. Some States, Territories and Countries do not allow certain liability exclusions or damages limitations, so to that extent the above may not apply to you.

Export Control. You shall not export from anywhere any part of the Data or any direct product thereof except in compliance with, and with all licenses and approvals required under, applicable export laws, rules and regulations, including but not limited to the laws, rules and regulations administered by the Office of Foreign Assets Control of the U.S. Department of Commerce and the Bureau of Industry and Security of the U.S. Department of Commerce. To the extent that any such

export laws, rules or regulations prohibit HERE from complying with any of its obligations hereunder to deliver or distribute Data, such failure shall be excused and shall not constitute a breach of this Agreement.

Entire Agreement. These terms and conditions constitute the entire agreement between Telenav (and its licensors, including their licensors and suppliers) and you pertaining to the subject matter hereof, and supersedes in their entirety any and all written or oral agreements previously existing between us with respect to such subject matter.

Governing Law. The above terms and conditions shall be governed by the laws of the State of Illinois [insert "Netherlands" where European HERE Data is used], without giving effect to (i) its conflict of laws provisions, or (ii) the United Nations Convention for Contracts for the International Sale of Goods, which is explicitly excluded. You agree to submit to the jurisdiction of the State of Illinois [insert "The Netherlands" where European HERE Data is used] for any and all disputes, claims and actions arising from or in connection with the Data provided to you hereunder.

Government End Users. If the Data is being acquired by or on behalf of the United States government or any other entity seeking or applying rights similar to those customarily claimed by the United States government, this Data is a "commercial item" as that term is defined at 48 C.F.R. ("FAR") 2.101, is licensed in accordance with these End-User Terms, and each copy of Data delivered or otherwise furnished shall be marked and embedded as appropriate with the following "Notice of Use," and shall be treated in accordance with such Notice:

Appendices

NOTICE OF USE

CONTRACTOR (MANUFACTURER/
SUPPLIER) NAME: HERE

CONTRACTOR (MANUFACTURER/
SUPPLIER) ADDRESS: c/o Nokia, 425
West Randolph Street, Chicago, Illinois
60606

This Data is a commercial item as
defined in FAR 2.101 and is subject to
these End-User Terms under which this
Data was provided.

© 1987 – 2014 HERE – All rights reserved.

If the Contracting Officer, federal government agency, or any federal official refuses to use the legend provided herein, the Contracting Officer, federal government agency, or any federal official must notify HERE prior to seeking additional or alternative rights in the Data.

I. US/Canada Territory

A. United States Data. The End-User Terms for any Application containing Data for the United States shall contain the following notices:

“HERE holds a non-exclusive license from the United States Postal Service® to publish and sell ZIP+4® information.”

“©United States Postal Service® 20XX. Prices are not established, controlled or approved by the United States Postal Service®. The following trademarks and registrations are owned by the USPS: United States Postal Service, USPS, and ZIP+4.”

B. Canada Data. The following provisions apply to the Data for Canada, which may include or reflect data from third party licensors (“Third Party Data”), including Her Majesty the Queen in Right of Canada (“Her Majesty”), Canada Post Corporation (“Canada Post”) and the Department of Natural Resources of Canada (“NRCan”):

1. Disclaimer and Limitation: Client agrees that its use of the Third Party Data is subject to the following provisions:

a. Disclaimer: The Third Party Data is licensed on an “as is” basis. The licensors of such data, including Her Majesty, Canada Post and NRCan, make no guarantees, representations or warranties respecting such data, either express or implied, arising by law or otherwise, including but not limited to, effectiveness, completeness, accuracy or fitness for a particular purpose.

b. Limitation on Liability: The Third Party Data licensors, including Her Majesty, Canada Post and NRCan, shall not be liable: (i) in respect of any claim, demand or action, irrespective of the nature of the cause of the claim, demand or action alleging any loss, injury or damages, direct or indirect, which may result from the use or possession of such Data; or (ii) in any way for loss of revenues or contracts, or any other consequential loss of any kind resulting from any defect in the Data.

Appendices

2. Copyright Notice: In connection with each copy of all or any portion of the Data for the Territory of Canada, Client shall affix in a conspicuous manner the following copyright notice on at least one of: (i) the label for the storage media of the copy; (ii) the packaging for the copy; or (iii) other materials packaged with the copy, such as user manuals or end user license agreements: "This data includes information taken with permission from Canadian authorities, including © Her Majesty the Queen in Right of Canada, © Queen's Printer for Ontario, © Canada Post Corporation, GeoBase®, © The Department of Natural Resources Canada. All rights reserved!"

3. End-User Terms: Except as otherwise agreed by the parties, in connection with the provision of any portion of the Data for the Territory of Canada to End-Users as may be authorized under the Agreement, Client shall provide such End-Users, in a reasonably conspicuous manner, with terms (set forth with other end user terms required to be provided under the Agreement, or as otherwise may be provided, by Client) which shall include the following provisions on behalf of the Third Party Data licensors, including Her Majesty, Canada Post and NRCan:

The Data may include or reflect data of licensors, including Her Majesty the Queen in the Right of Canada ("Her Majesty"), Canada Post Corporation ("Canada Post") and the Department of Natural Resources Canada ("NRCan"). Such data is licensed on an "as is" basis. The licensors, including Her Majesty, Canada Post and NRCan, make no guarantees, representations or warranties respecting such data,

either express or implied, arising by law or otherwise, including but not limited to, effectiveness, completeness, accuracy or fitness for a particular purpose. The licensors, including Her Majesty, Canada Post and NRCan, shall not be liable in respect of any claim, demand or action, irrespective of the nature of the cause of the claim, demand or action alleging any loss, injury or damages, direct or indirect, which may result from the use or possession of the data or the Data. The licensors, including Her Majesty, Canada Post and NRCan, shall not be liable in any way for loss of revenues or contracts, or any other consequential loss of any kind resulting from any defect in the data or the Data.

End User shall indemnify and save harmless the licensors, including Her Majesty, Canada Post and NRCan, and their officers, employees and agents from and against any claim, demand or action, irrespective of the nature of the cause of the claim, demand or action, alleging loss, costs, expenses, damages or injuries (including injuries resulting in death) arising out of the use or possession of the data or the Data.

4. Additional Provisions: The terms contained in this Section are in addition to all of the rights and obligations of the parties under the Agreement. To the extent that any of the provisions of this Section are inconsistent with, or conflict with, any other provisions of the Agreement, the provisions of this Section shall prevail.

Appendices

II. Mexico. The following provision applies to the Data for Mexico, which includes certain data from the Instituto Nacional de Estadística y Geografía (“INEGI”):

A. Any and all copies of the Data and/or packaging containing Data for Mexico shall contain the following notice: “Fuente: INEGI (Instituto Nacional de Estadística y Geografía)”

III. Latin America Territory

A. Third Party Notices. Any and all copies of the Data and/or packaging relating thereto shall include the respective Third Party Notices set forth below and used as described below corresponding to the Territory (or portion thereof) included in such copy:

Territory Notice

Ecuador “INSTITUTO GEOGRAFICO MILITAR DEL ECUADOR AUTORIZACION N° IGM-2011-01- PCO-01 DEL 25 DE ENERO DE 2011”
“source: © IGN 2009 - BD TOPO ®”

Guadeloupe, French Guiana and Martinique Mexico “Fuente: INEGI (Instituto Nacional de Estadística y Geografía)”

IV. Middle East Territory

A. Third Party Notices. Any and all copies of the Data and/or packaging relating thereto shall include the respective Third Party Notices set forth below and used as described below corresponding to the Territory (or portion thereof) included in such copy:

Country Notice

Jordan “© Royal Jordanian Geographic Centre”. The foregoing notice requirement for Jordan Data is a material term of the Agreement. If Client or any of its permitted sublicensees (if any) fail to meet such requirement, HERE shall have the right to terminate Client’s license with respect to the Jordan Data.

B. Jordan Data. Client and its permitted sublicensees (if any) are restricted from licensing and/or otherwise distributing HERE’s database for the country of Jordan (“Jordan Data”) for use in Enterprise Applications to (i) non-Jordanian entities for use of the Jordan Data solely in Jordan or (ii) Jordan-based customers. In addition, Client, its permitted sublicensees (if any) and End-Users are restricted from using the Jordan Data in Enterprise Applications if such party is (i) a non-Jordanian entity using the Jordan Data solely in Jordan or (ii) a Jordan-based customer. For purposes of the foregoing, “Enterprise Applications” shall mean Geomarketing applications, GIS applications, mobile business asset management applications, call center applications, telematics applications, public organization Internet applications or for providing geocoding services.

Appendices

V. Europe Territory

A. Use of Certain Traffic Codes in Europe

1. General Restrictions Applicable to Traffic Codes. Client acknowledges and agrees that in certain countries of the Europe Territory, Client will need to obtain rights directly from third party RDS-TMC code providers to receive and use the Traffic Codes in the Data and to deliver to End-Users Transactions in any way derived from or based on such Traffic Codes. For such countries, HERE shall deliver the Data incorporating Traffic Codes to Client only after receiving certification from Client of its having obtained such rights.

2. Display of Third Party Rights Legends for Belgium. Client shall, for each Transaction that uses Traffic Codes for Belgium, provide the following notice to the End-User: "Traffic Codes for Belgium are provided by the Ministerie van de Vlaamse Gemeenschap and the Ministère de l'Équipement et des Transports."

B. Paper Maps. With respect to any license granted to Client relating to making, selling or distributing paper maps (i.e., a map fixed on a paper or paper-like medium): (a) such license with respect to Data for the Territory of Great Britain is conditioned on Client's entering into and complying with a separate written agreement with the Ordnance Survey ("OS") to create and sell paper maps, Client's paying to the OS any and all applicable paper map royalties, and Client's complying with the OS copyright notice requirements; (b) such license for selling or otherwise distributing for charge with respect to Data for the Territory of Czech Republic

is conditioned on Client's obtaining prior written consent from Kartografie a.s.; (c) such license for selling or distributing with respect to Data for the Territory of Switzerland is conditioned on Client's obtaining a permit from Bundesamt für Landestopografie of Switzerland; (d) Client is restricted from using Data for the Territory of France to create paper maps with a scale between 1:5,000 and 1:250,000; and (e) Client is restricted from using any Data to create, sell or distribute paper maps that are the same or substantially similar, in terms of data content and specific use of color, symbols and scale, to paper maps published by the European national mapping agencies, including without limitation, Landvermessungämter of Germany, Topografische Dienst of the Netherlands, Nationaal Geografisch Instituut of Belgium, Bundesamt für Landestopografie of Switzerland, Bundesamt für Eich-und Vermessungswesen of Austria, and the National Land Survey of Sweden.

C. OS Enforcement. Without limiting Section IV(B) above, with respect to Data for the Territory of Great Britain, Client acknowledges and agrees that the Ordnance Survey ("OS") may bring a direct action against Client to enforce compliance with the OS copyright notice (see Section IV(D) below) and paper map requirements (see Section IV(B) above) contained in this Agreement.

D. Third Party Notices. Any and all copies of the Data and/or packaging relating thereto shall include the respective Third Party Notices set forth below and used as described below corresponding to the Territory (or portion thereof) included in such copy:

Country(ies) Notice

Appendices

Austria	“© Bundesamt für Eich- und Vermessungswesen”	Spain	“Información geográfica propiedad del CNIG”
Croatia		Sweden	“Based upon electronic data © National Land Survey Sweden.”
Cyprus,		Switzerland	“Topografische Grundlage: © Bundesamt für Landestopographie.
Estonia,			E. Respective Country Distribution. Client acknowledges that HERE has not received approvals to distribute map data for the following countries in such respective countries: Albania, Belarus, Kyrgyzstan, Moldova and Uzbekistan. HERE may update such list from time to time. The license rights granted to Client under this TL with respect to the Data for such countries are contingent upon Client’s compliance with all applicable laws and regulations, including, without limitation, any required licenses or approvals to distribute the Application incorporating such Data in such respective countries.
Latvia,	“© EuroGeographics”		
Lithuania,			
Moldova,			
Poland,			
Slovenia			
and/or			
Ukraine			
France	“source: © IGN 2009 – BD TOPO ®”		
Germany	“Die Grundlagendaten wurden mit Genehmigung der zuständigen Behörden entnommen”		
Great Britain	“Contains Ordnance Survey data © Crown copyright and database right 2010 Contains Royal Mail data © Royal Mail copyright and database right 2010”		
Greece	“Copyright Geomatics Ltd.”	VI. Australia Territory	
Hungary	“Copyright © 2003; Top-Map Ltd.”		A. Third Party Notices. Any and all copies of the Data and/or packaging relating thereto shall include the respective Third Party Notices set forth below and used as described below corresponding to the Territory (or portion thereof) included in such copy:
Italy	“La Banca Dati Italiana è stata prodotta usando quale riferimento anche cartografia numerica ed al tratto prodotta e fornita dalla Regione Toscana.”		Copyright. Based on data provided under license from PSMA Australia Limited (www.pasma.com.au).
Norway	“Copyright © 2000; Norwegian Mapping Authority”		
Portugal	“Source: IgeoE – Portugal”		

Appendices

Product incorporates data which is © 20XX Telstra Corporation Limited, GM Holden Limited, Intelomatics Australia Pty Ltd and Continental Pty Ltd.

B. Third Party Notices for Australia. In addition to the foregoing, the End-User Terms for any Application containing RDS-TMC Traffic Codes for Australia shall contain the following notice: “Product incorporates traffic location codes which is © 20XX Telstra Corporation Limited and its licensors.”

VII. China Territory

Personal Use Only

You agree to use this Data together with [insert name of Client Application] for the solely personal, non-commercial purposes for which you were licensed, and not for service bureau, time-sharing or other similar purposes. Accordingly, but subject to the restrictions set forth in the following paragraphs, you may copy this Data only as necessary for your personal use to (i) view it, and (ii) save it, provided that you do not remove any copyright notices that appear and do not modify the Data in any way. You agree not to otherwise reproduce, copy, modify, decompile, disassemble or reverse engineer any portion of this Data, and may not transfer or distribute it in any form, for any purpose, except to the extent permitted by mandatory laws.

Restrictions

Except where you have been specifically licensed to do so by NAV2, and without limiting the preceding paragraph, you may not (a) use this Data with any products, systems, or applications installed or otherwise connected to or in communication with vehicles, capable of vehicle navigation, positioning, dispatch, real time route guidance, fleet management or similar applications; or (b)

with or in communication with any positioning devices or any mobile or wireless-connected electronic or computer devices, including without limitation cellular phones, palmtop and handheld computers, pagers, and personal digital assistants or PDAs. You agree to cease using this Data if you fail to comply with these terms and conditions.

Limited Warranty

NAV2 warrants that (a) the Data will perform substantially in accordance with the accompanying written materials for a period of ninety (90) days from the date of receipt, and (b) any support services provided by NAV2 shall be substantially as described in applicable written materials provided to you by NAV2, and NAV2's support engineers will make commercially reasonable efforts to solve any problem issues.

rigCustomer Remedies

NAV2 and its suppliers' entire liability and your exclusive remedy shall be, at NAV2's sole discretion, either (a) return of the price paid, if any, or (b) repair or replacement of the Data that do not meet NAV2's Limited Warranty and that are returned to NAV2 with a copy of your receipt. This Limited Warranty is void if failure of the Data has resulted from accident, abuse, or misapplication. Any replacement Data will be warranted for the remainder of the original warranty period or thirty (30) days, whichever is longer. Neither these remedies nor any product support services offered by NAV2 are available without proof of purchase from an authorized international source.

Appendices

No Other Warranty:

EXCEPT FOR THE LIMITED WARRANTY SET FORTH ABOVE AND TO THE EXTENT PERMITTED BY APPLICABLE LAW, NAV2 AND ITS LICENSORS (INCLUDING THEIR LICENSORS AND SUPPLIERS) DISCLAIM ANY WARRANTIES, EXPRESS OR IMPLIED, OF QUALITY, PERFORMANCE, MERCHANTABILITY, FITNESS FOR A PARTICULAR PURPOSE, OWNERSHIP OR NON-INFRINGEMENT. Certain warranty exclusions may not be permitted under applicable law, so to that extent the above exclusion may not apply to you.

Limited Liability:

TO THE EXTENT PERMITTED BY APPLICABLE LAW, NAV2 AND ITS LICENSORS (INCLUDING THEIR LICENSORS AND SUPPLIERS) SHALL NOT BE LIABLE TO YOU: IN RESPECT OF ANY CLAIM, DEMAND OR ACTION, IRRESPECTIVE OF THE NATURE OF THE CAUSE OF THE CLAIM, DEMAND OR ACTION ALLEGING ANY LOSS, INJURY OR DAMAGES, DIRECT OR INDIRECT, WHICH MAY RESULT FROM THE USE OR POSSESSION OF THE INFORMATION; OR FOR ANY LOSS OF PROFIT, REVENUE, CONTRACTS OR SAVINGS, OR ANY OTHER DIRECT, INDIRECT, INCIDENTAL, SPECIAL OR CONSEQUENTIAL DAMAGES ARISING OUT OF YOUR USE OF OR INABILITY TO USE THIS INFORMATION, ANY DEFECT IN THE INFORMATION, OR THE BREACH OF THESE TERMS OR CONDITIONS, WHETHER IN AN ACTION IN CONTRACT OR TORT OR BASED ON A WARRANTY, EVEN IF NAV2 OR ITS LICENSORS HAVE BEEN ADVISED OF THE POSSIBILITY OF SUCH DAMAGES. UNDER NO CIRCUMSTANCES SHALL NAV2'S OR ITS SUPPLIERS' LIABILITY HEREUNDER EXCEED THE PRICE PAID. Certain liability exclusions may not be permitted under applicable law, so to that extent the above exclusion may not apply to you.

Export Control

You agree not to export to anywhere any part of the Data provided to you or any direct product thereof except in compliance with, and with all licenses and approvals required under, applicable export laws, rules and regulations.

IP Protection

The Data are owned by NAV2 or its suppliers and are protected by applicable copyright and other intellectual property law and treaties. The Data are provided solely on the basis of a license to use, not sale.

Entire Agreement

These terms and conditions constitute the entire agreement between NAV2 (and its licensors, including their licensors and suppliers) and you pertaining to the subject matter hereof, and supersedes in their entirety any and all written or oral agreements previously existing between us with respect to such subject matter.

Governing Law.

The above terms and conditions shall be governed by the laws of the People's Republic of China, without giving effect to (i) its conflict of laws provisions, or (ii) the United Nations Convention for Contracts for the International Sale of Goods, which is explicitly excluded. Any dispute arising from or in connection with the Data provided to you hereunder shall be submitted to the Shanghai International Economic and Trade Arbitration Commission for arbitration.

Gracenote® Copyright

CD and music-related data from Gracenote, Inc., copyright©

Appendices

2000-2007 Gracenote. Gracenote Software, copyright © 2000-2007 Gracenote. This product and service may practice one or more of the following U.S. Patents 5,987,525; 6,061,680; 6,154,773; 6,161,132; 6,230,192; 6,230,207; 6,240,459; 6,330,593 and other patents issued or pending. Some services supplied under license from Open Globe, Inc. for U.S. Patent 6,304,523.

Gracenote and CDDB are registered trademarks of Gracenote. The Gracenote logo and logotype, and the "Powered by Gracenote™" logo are trademarks of Gracenote.

Gracenote® End User License Agreement (EULA)

This device contains software from Gracenote, Inc. of 2000 Powell Street Emeryville, California 94608 ("Gracenote").

The software from Gracenote (the "Gracenote Software") enables this device to do disc and music file identification and obtain music-related information, including name, artist, track, and title information ("Gracenote Data") from online servers ("Gracenote Servers"), and to perform other functions. You may use Gracenote Data only by means of the intended End User functions of this device. This device may contain content belonging to Gracenote's providers. If so, all of the restrictions set forth herein with respect to Gracenote Data shall also apply to such content and such content providers shall be entitled to all of the benefits and protections set forth herein that are available to Gracenote. You agree that you will use the content from Gracenote ("Gracenote Content"), Gracenote Data, the Gracenote Software, and Gracenote Servers for your own personal, non-commercial use only. You agree not to assign, copy, transfer or transmit the Gracenote Content, Gracenote Software

or any Gracenote Data (except in a Tag associated with a music file) to any third party. YOU AGREE NOT TO USE OR EXPLOIT GRACENOTE CONTENT, GRACENOTE DATA, THE GRACENOTE SOFTWARE, OR GRACENOTE SERVERS, EXCEPT AS EXPRESSLY PERMITTED HEREIN.

You agree that your non-exclusive licenses to use the Gracenote Content, Gracenote Data, the Gracenote Software, and Gracenote Servers will terminate if you violate these restrictions. If your licenses terminate, you agree to cease any and all use of the Gracenote Content, Gracenote Data, the Gracenote Software, and Gracenote Servers.

Gracenote, respectively, reserve all rights in Gracenote Data, the Gracenote Software, and the Gracenote Servers and Gracenote Content, including all ownership rights. Under no circumstances will either Gracenote become liable for any payment to you for any information that you provide, including any copyrighted material or music file information. You agree that Gracenote may enforce its respective rights, collectively or separately, under this agreement against you, directly in each company's own name.

Gracenote uses a unique identifier to track queries for statistical purposes. The purpose of a randomly assigned numeric identifier is to allow Gracenote to count queries without knowing anything about who you are. For more information, see the web page at www.gracenote.com for the Gracenote Privacy Policy.

THE GRACENOTE SOFTWARE, EACH ITEM OF GRACENOTE DATA AND THE GRACENOTE CONTENT ARE LICENSED TO YOU "AS IS". NEITHER GRACENOTE MAKES ANY REPRESENTATIONS OR WARRANTIES, EXPRESS OR IMPLIED, REGARDING THE ACCURACY OF ANY GRACENOTE DATA FROM THE

Appendices

GRACENOTE SERVERS OR GRACENOTE CONTENT. GRACENOTE COLLECTIVELY AND SEPARATELY RESERVE THE RIGHT TO DELETE DATA AND/OR CONTENT FROM THE COMPANIES' RESPECTIVE SERVERS OR, IN THE CASE OF GRACENOTE, CHANGE DATA CATEGORIES FOR ANY CAUSE THAT GRACENOTE DEEMS SUFFICIENT. NO WARRANTY IS MADE THAT EITHER GRACENOTE CONTENT OR THE GRACENOTE SOFTWARE OR GRACENOTE SERVERS ARE ERROR-FREE OR THAT THE FUNCTIONING OF THE GRACENOTE SOFTWARE OR GRACENOTE SERVERS WILL BE UNINTERRUPTED. GRACENOTE IS NOT OBLIGATED TO PROVIDE YOU WITH ANY ENHANCED OR ADDITIONAL DATA TYPES THAT GRACENOTE MAY CHOOSE TO PROVIDE IN THE FUTURE AND IS FREE TO DISCONTINUE ITS ONLINE SERVICES AT ANY TIME. GRACENOTE DISCLAIM ALL WARRANTIES EXPRESS OR IMPLIED, INCLUDING, BUT NOT LIMITED TO, IMPLIED WARRANTIES OF MERCHANTABILITY, FITNESS FOR A PARTICULAR PURPOSE, TITLE, AND NON-INFRINGEMENT. NEITHER GRACENOTE WARRANTS THE RESULTS THAT WILL BE OBTAINED BY YOUR USE OF THE GRACENOTE SOFTWARE OR ANY GRACENOTE SERVER. IN NO CASE WILL GRACENOTE BE LIABLE FOR ANY CONSEQUENTIAL OR INCIDENTAL DAMAGES OR FOR ANY LOST PROFITS OR LOST REVENUES FOR ANY REASON WHATSOEVER. © Gracernote 2007.

Radio Frequency Statement

FCC ID: ACJ-SYNCG3-L

IC: 216B-SYNCG3-L

This device complies with Part 15 of the FCC Rules and with RSS-210 of Industry Canada. Operation is subject to the following two conditions:

(1) This device may not cause harmful interference, and

(2) this device must accept any interference received, including interference that may cause undesired operation.

Note: *Changes or modifications not expressly approved by the party responsible for compliance could void the user's authority to operate the equipment. The term "IC" before the radio certification number only signifies that Industry Canada technical specifications were met.*

The antenna used for this transmitter must not be co-located or operating in conjunction with any other antenna or transmitter.

Taiwan Territory

Note: In accordance with the management approach of low-power radio wave radiation motors:

Article 12: For approved and certified low-power radiation motor models, companies, firms or users must not alter the frequency, increase the power or change the characteristics and functions of the original design without authorization.

Article 14: The usage of low-power radio-frequency motors must not affect aviation safety and interfere with legal telecommunications. Should interference be detected, immediately stop using the device and only resume usage after ensuring that there is no longer any interference. For the legal telecommunication and wireless telecommunication of the telco, the low-power radio frequency motor must be able to tolerate legal limits of interference from telecommunication, industrial, scientific and radio wave equipment.

Appendices

SUNA TRAFFIC CHANNEL – TERMS AND CONDITIONS

By activating, using and/or accessing the SUNA Traffic Channel, SUNA Predictive or other content or material provided by Intelematics (together, **SUNA Products and/or Services**), you must accept certain terms and conditions. The following is a brief summary of the terms and conditions that apply to you. To view the full terms and conditions relevant to your use of the SUNA Products and/or Services, please consult:

Website
www.sunattraffic.com.au/termsandconditions/

1. Acceptance

By using SUNA Products and/or Services, you will be deemed to have accepted and agreed to be bound by the terms and conditions fully detailed at:

Website
www.sunattraffic.com.au/termsandconditions/

2. Intellectual Property

SUNA Products and/or Services are for your personal use. You may not record, or retransmit the content, nor use the content in association with any other traffic information or route guidance service or device not approved by Intelematics. You obtain no right of ownership in any Intellectual Property Rights (including copyright) in the data that is used to provide SUNA Products and/or Services.

3. Appropriate Use

SUNA Products and/or Services are intended as an aid to personal motoring and travel planning, and do not provide comprehensive or accurate information on all occasions. On occasions, you may experience additional delay as a result of using SUNA Products and/or Services. You acknowledge that it is not intended, or suitable, for use in applications where time of arrival or driving directions may impact the safety of the public or yourself.

4. Use of SUNA Products and Services while driving

You, and other authorised drivers of the vehicle in which SUNA Products and/or Services are available or installed and active, remain at all times responsible for observing all relevant laws and codes of safe driving. In particular, you agree to only actively operate SUNA Products and/or Services when the Vehicle is at a complete stop and it is safe to do so.

5. Service Continuity and Reception of the SUNA Traffic Channel

We will use reasonable endeavours to provide the SUNA Traffic Channel 24 hours a day, 365 days a year. The SUNA Traffic Channel may occasionally be unavailable for technical reasons or for planned maintenance. We will try to perform maintenance at times when congestion is light. We reserve the right to withdraw SUNA Products and/or Services at any time.

Also, we cannot assure the uninterrupted reception of the SUNA Traffic Channel RDS-TMC signal at any particular location.

6. Limitation of Liability

Neither Intelematics (nor its suppliers or the manufacturer of your device (the **"Suppliers"**)) shall be liable to you or to any third party for any damages either direct, indirect, incidental, consequential or otherwise arising out of the use of or inability to use SUNA Products and/or

Appendices

Services even if Intelematics or a Supplier has been advised of the possibility of such damages. You also acknowledge that the neither Intelematics nor any Supplier guarantees nor make any warranties that relate to the availability, accuracy or completeness of SUNA Products and/or Services, and to the extent which it is lawful to do so, both Intelematics and each Supplier excludes any warranties which might otherwise be implied by any State or Federal legislation in relation to SUNA Products and/or Services.

7. Please Note

Great care has been taken in preparing this manual. Constant product development may mean that some information is not entirely up-to-date. The information in this document is subject to change without notice.

WARNING



Driving while distracted can result in loss of vehicle control, crash and injury. We strongly recommend that you use extreme caution when using any device that may take your focus off the road. Your primary responsibility is the safe operation of your vehicle. We recommend against the use of any hand-held device while driving and encourage the use of voice-operated systems when possible. Make sure you are aware of all applicable local laws that may affect the use of electronic devices while driving.

TYPE APPROVALS

RF Certification Logos for Tire Pressure Monitoring Sensor (s)



Schrader AG2SZ4 Numero de Registro
CNC: H-13498

E207816

Argentina



TRA
REGISTERED NO:ER0130238/14
DEALER NO:DA0047074/10

E207817

Abu Dhabi, Dubai



MODELO: AG2SZ3
2109-14-8001
ANATEL
(01)0789895330292

E197509

Appendices



E202555

Brazil



E197811

Moldova

Herby, Schrader Electronics UK Ltd., declares that this TPMS is in compliance with the essential requirements and other provisions of directive 1999/5/EC. The declaration of conformity may be consulted at emcteam@schrader.co.uk

E207818

European Union EU

AGREE PAR L'ANRT MAROC
Numéro d'agrément: MR9098
ANRT 2014
Date d'agrément: 14/03/2014

E207821

Morocco

Kingdom of Jordan Type approval for tyre pressure sensor.
Model: AG2SZ4
Manufacturer: Schrader Electronics
Type Approval Number: TRC/LPD/2014/56

E207819

Jordan



Type Approved

NTC

No:ESD-1408639C

E198001

Philippines

RAQP/33A/0514/S/(14-0847)

E207820

Malaysia



E197844

Serbia

Appendices

Complies with
IDA Standards
DA 00461



CCAM14LP0090T3

E207822

Singapore



TA-2014/064

Approved

E203679

Taiwan



E198002

South Africa



CCAM14LP0460T0

Schrader Electronics цім стверджує, що обладнання Радіопередавач моделі AG2S24 системи контролю тиску в шині автомобіля відповідає вимогам Технічного регламенту радіоблагоднання і телекомунікаційного кінцевого (термінального) обладнання (Постанова КМУ № 679 від 24 червня 2009 р.) Декларація відповідності знаходиться на сайті Schrader

Electronics та надається за запитом на електронну адресу doc.request@schrader.co.uk

E198009

Ukraine

E203899

Index

A

A/C	
See: Climate Control.....	102
About This Manual.....	7
ABS	
See: Brakes.....	142
ABS driving hints	
See: Hints on Driving With Anti-Lock Brakes.....	142
Accessories.....	418
Exterior Style.....	418
Interior Style.....	418
Lifestyle.....	418
Peace of Mind.....	418
Accessories	
See: Replacement Parts	
Recommendation.....	12
ACC	
See: Using Adaptive Cruise Control.....	156
Adjusting the Headlamps.....	224
Horizontal Aim Adjustment.....	225
Vertical Aim Adjustment.....	224
Adjusting the Steering Wheel.....	64
Airbag Disposal.....	45
Air Conditioning	
See: Climate Control.....	102
Air Filter	
See: Changing the Engine Air Filter.....	229
Alarm	
See: Anti-Theft Alarm.....	63
Ambient Lighting.....	72
Anti-Theft Alarm.....	63
Arming the Alarm.....	63
Disarming the Alarm.....	63
Appendices.....	440
Apps.....	390
.....	390
SiriusXM Traffic and Travel Link.....	392
At a Glance.....	16
Audible Warnings and Indicators.....	82
Headlamps On Warning Chime.....	82
Keyless Warning Alert.....	82
Parking Brake On Warning Chime.....	82
Audio Control.....	64
MEDIA.....	64
Seek, Next or Previous.....	64

Audio System.....	293
General Information.....	293
Audio Unit - Vehicles With: AM/FM/CD/ SYNC/Touchscreen Display.....	299
Audio Unit - Vehicles With: AM/FM/CD/ SYNC.....	294
Menu Structure.....	296
Autolamps.....	69
Windshield Wiper Activated	
Headlamps.....	69
Automatic Climate Control.....	103
Automatic Transmission.....	138
Automatic Transmission Adaptive Learning.....	140
Brake-Shift Interlock.....	139
If Your Vehicle Gets Stuck In Mud or Snow.....	140
SelectShift Automatic™	
Transmission.....	138
Understanding the Positions of Your Automatic Transmission.....	138
Automatic Transmission Fluid Check.....	220
Autowipers.....	66
Auxiliary Power Points.....	120
12 Volt DC Power Point.....	120
Locations.....	120

B

Battery	
See: Changing the 12V Battery.....	222
Blind Spot Information System.....	162
Switching the System Off and On.....	164
System Errors.....	163
Using the System.....	162
Bonnet Lock	
See: Opening and Closing the Hood.....	210
Booster Seats.....	25
Types of Booster Seats.....	26
Brake Fluid Check.....	221
Brakes.....	142
General Information.....	142
Breaking-In.....	185
Bulb Specification Chart.....	228

Index

C	
Cabin Air Filter.....	107
California Proposition 65.....	11
Capacities and Specifications - 2.3L	
EcoBoost™.....	278
Alternative Engine Oil for Extremely Cold	
Climates.....	282
Specifications.....	279
Capacities and Specifications -	
3.7L.....	283
Alternative Engine Oil for Extremely Cold	
Climates.....	287
Specifications.....	284
Capacities and Specifications -	
5.0L.....	288
Alternative Engine Oil for Extremely Cold	
Climates.....	292
Specifications.....	289
Capacities and Specifications.....	271
Car Wash	
See: Cleaning the Exterior.....	231
Center Console.....	121
Locking Storage Bin.....	121
Changing a Bulb.....	226
Accessing the Direction Indicator and Fog	
Lamp Bulbs.....	226
Lamp Assembly Condensation.....	226
Replacing Fog Lamp Bulbs (If	
Equipped).....	227
Replacing HID Headlamp Bulbs.....	226
Replacing LED Fog Lamp Bulbs (If	
Equipped).....	227
Replacing rear, Brake, High-Mount Brake,	
Rear Direction Indicator and License	
Plate Lamp Bulbs.....	227
Replacing Reverse Lamp Bulbs.....	227
Replacing the Direction Indicator	
Bulbs.....	227
Changing a Fuse.....	208
Fuses.....	208
Changing a Road Wheel.....	264
Dissimilar Spare Wheel and Tire Assembly	
Information.....	264
Tire Change Procedure.....	265
Changing the 12V Battery.....	222
Battery Management System.....	223
Changing the Engine Air Filter.....	229
Changing the Wiper Blades.....	224
Checking MyKey System Status.....	54
Checking the Wiper Blades.....	224
Child Restraint and Seatbelt	
Maintenance.....	35
Child Restraint Positioning.....	27
Child Safety.....	18
General Information.....	18
Cleaning Leather Seats.....	234
Cleaning Products.....	230
Cleaning the Convertible Top.....	237
Cleaning the Engine.....	232
Cleaning the Exterior.....	231
Exterior Chrome Parts.....	231
Exterior Plastic Parts.....	231
Stripes or Graphics.....	231
Underbody.....	232
Under Hood.....	232
Cleaning the Instrument Panel and	
Instrument Cluster Lens.....	234
Cleaning the Interior.....	233
Cleaning the Wheels.....	235
Cleaning the Windows and Wiper	
Blades.....	233
Clearing All MyKeys.....	53
Climate.....	373
Climate Control.....	102
Climate Controlled Seats.....	114
Cooled Seats.....	114
Closing the Convertible Top.....	183
Clutch Fluid Check.....	221
Collision Warning System.....	168
PRINCIPLE OF OPERATION.....	168
Convertible Top.....	182
Coolant Check	
See: Engine Coolant Check.....	216
Crash Sensors and Airbag Indicator.....	44
Creating a MyKey.....	52
Programming/Changing Configurable	
Settings.....	52
Cross Traffic Alert.....	164
False Alerts.....	166
Switching the System Off and On.....	167
System Errors.....	167
System Lights, Messages and Audible	
Alerts.....	166
System Limitations.....	166
Using the System.....	164

Index

Cruise Control.....65	Engine Block Heater.....125
Principle of Operation.....155	Using the Engine Block Heater.....126
Type 1.....65	Engine Coolant Check.....216
Type 2.....65	Adding Coolant.....217
Cruise control	Coolant Change.....218
See: Using Cruise Control.....155	Engine Coolant Temperature
Customer Assistance.....194	Management.....219
D	Fail-Safe Cooling.....218
Data Recording.....9	Recycled Coolant.....218
Event Data Recording.....10	Severe Climates.....218
Service Data Recording.....9	Engine Immobilizer
Daytime Running Lamps.....70	See: Passive Anti-Theft System.....62
Type 1 - Conventional	Engine Oil Check.....215
(Non-Configurable).....70	Adding Engine Oil.....215
Type 2 - Configurable.....71	Engine Oil Dipstick.....215
Digital Radio.....300	Engine Specifications - 2.3L
HD Radio Reception and Station	EcoBoost™.....271
Troubleshooting.....301	Drivebelt Routing.....271
Direction Indicators.....71	Engine Specifications - 3.7L.....271
Doors and Locks.....56	Drivebelt Routing.....272
Drive Control.....170	Engine Specifications - 5.0L.....272
Selectable Drive Modes.....170	Drivebelt Routing.....272
Selectable Steering.....171	Entertainment.....363
Driver and Passenger Airbags.....38	AM/FM Radio.....364
Children and Airbags.....38	Apps.....372
Proper Driver and Front Passenger Seating	Bluetooth Stereo or USB.....371
Adjustment.....38	CD (If equipped).....370
Driver and Passenger Knee Airbags.....43	HD Radio™ Information (If
Driving Aids.....162	Available).....367
Driving at High Speed.....269	SIRIUS® Satellite Radio (If
Driving Hints.....185	Activated).....365
Driving Through Water.....185	Sources.....363
DRL	Supported Media Players, Formats and
See: Daytime Running Lamps.....70	Metadata Information.....372
E	USB Ports.....372
Economical Driving.....185	Environment.....15
Emission Control System.....133	Essential Towing Checks.....179
On-Board Diagnostics (OBD-II).....134	Before Towing a Trailer.....179
Readiness for Inspection and Maintenance	Hitches.....179
(I/M) Testing.....134	Launching or Retrieving a Boat or Personal
End User License Agreement.....440	Watercraft (PWC).....180
VEHICLE SOFTWARE END USER LICENSE	Safety Chains.....179
AGREEMENT (EULA)440	Trailer Brakes.....179
	Trailer Lamps.....179
	When Towing a Trailer.....180
	Event Data Recording
	See: Data Recording.....9
	Export Unique Options.....14

Index

Exterior Mirrors.....	74
Blind Spot Monitor.....	75
Fold-Away Exterior Mirrors.....	74
Heated Exterior Mirrors.....	74
Integrated Blind Spot Mirrors.....	74
Memory Mirrors.....	74
Pony Projection Lights.....	74
Power Exterior Mirrors.....	74
Signal Indicator Mirrors.....	74

F

Fastening the Seatbelts.....	30
Seatbelt Locking Modes.....	32
Using Seatbelts During Pregnancy.....	31
Flat Tire Inflation	
See: Tire Sealant and Inflator Kit.....	238
Floor Mats.....	186
Fog Lamps - Front	
See: Front Fog Lamps.....	71
Ford Credit.....	11
US Only.....	11
Ford Protect.....	420
Ford Protect Extended Service Plan (CANADA ONLY).....	421
Ford Protect Extended Service Plans (U.S. Only).....	420
Front Fog Lamps.....	71
Front Passenger Sensing System.....	39
Fuel and Refueling.....	127
Fuel Consumption.....	132
Calculating Fuel Economy.....	132
Filling the Fuel Tank.....	132
Fuel Filler Funnel Location.....	128
Fuel Filter.....	222
Fuel Quality.....	128
Choosing the Right Fuel.....	128
Octane Recommendations.....	128
Fuel Shutoff.....	189
Fuses.....	201
Fuse Specification Chart.....	201
Passenger Compartment Fuse Panel.....	206
Power Distribution Box.....	201

G

Garage Door Opener	
See: Universal Garage Door Opener.....	116
Gauges.....	77
Engine Coolant Temperature Gauge.....	78
Fuel Gauge.....	78
Gauge Package.....	79
Information Display.....	77
Gearbox	
See: Transmission.....	136
General Information on Radio	
Frequencies.....	46
Intelligent Access.....	46
General Maintenance Information.....	422
Multi-Point Inspection.....	425
Owner Checks and Services.....	424
Protecting Your Investment.....	422
Why Maintain Your Vehicle?.....	422
Why Maintain Your Vehicle at Your Dealership?.....	422
Getting Assistance Outside the U.S. and Canada.....	197
Getting the Services You Need.....	194
Away From Home.....	194
Glasses Holder.....	121
Global Opening.....	73
Opening the Windows.....	74

H

Handbrake	
See: Parking Brake.....	143
Hazard Flashers.....	189
Headlamp Adjusting	
See: Adjusting the Headlamps.....	224
Headlamp Exit Delay.....	70
Head Restraints.....	109
Adjusting the Head Restraint.....	110
Front Seat Non-Adjustable Head Restraints	110
Tilting Head Restraints	110
Heated Windows and Mirrors.....	107
Heated Exterior Mirror.....	107
Heated Rear Window.....	107
Heating	
See: Climate Control.....	102

Index

Hill Start Assist.....	143	Tire Pressure Monitoring System.....	100
Switching the System On and Off.....	144	Traction Control.....	100
Using Hill Start Assist.....	144	Transmission.....	100
Hints on Controlling the Interior		Installing Child Restraints.....	19
Climate.....	105	Child Seats.....	19
Defogging the Side Windows in Cold		Using Lap and Shoulder Belts.....	20
Weather.....	107	Using Lower Anchors and Tethers for	
General Hints.....	105	CHildren (LATCH).....	22
Quickly Cooling the Interior.....	106	Using Tether Straps.....	23
Quickly Heating the Interior.....	105	Instrument Cluster.....	77
Recommended Settings for Cooling.....	106	Instrument Lighting Dimmer.....	69
Recommended Settings for Heating.....	106	Vehicles With Front Fog Lamps.....	70
Hints on Driving With Anti-Lock		Vehicles Without Front Fog Lamps.....	70
Brakes.....	142	Interior Panel Overview.....	16
Home Screen.....	355	Interior Lamps.....	72
Hood Lock		Interior Luggage Compartment	
See: Opening and Closing the Hood.....	210	Release.....	61
I		Interior Mirror.....	75
In California (U.S. Only).....	195	Auto-Dimming Mirror.....	75
Information Display Control.....	65	Introduction.....	7
Information Displays.....	83	J	
General Information.....	83	Jump Starting the Vehicle.....	190
Information Messages.....	91	Connecting the Jumper Cables.....	190
Adaptive Cruise Control.....	91	Jump Starting.....	191
AdvanceTrac™.....	92	Preparing Your Vehicle.....	190
Airbag.....	92	Removing the Jumper Cables.....	191
Alarm.....	93	K	
Battery and Charging System.....	93	Keyless Starting.....	122
Blind Spot Information and Cross Traffic		Ignition Modes.....	122
Alert System.....	94	Keys and Remote Controls.....	46
Collision Warning System.....	94	L	
Doors and Locks.....	94	Lighting Control.....	68
Engine.....	95	Headlamp Flasher.....	69
Fuel.....	95	High Beams.....	68
Hill Start Assist.....	95	Lighting.....	68
Keys and Intelligent Access.....	95	General Information.....	68
Maintenance.....	96	Limited Slip Differential.....	141
MyKey.....	97	Traction-Lok™ and TORSEN™ Axles.....	141
Park Aid.....	97	Load Carrying.....	172
Park Brake.....	98		
Rear Axle.....	98		
Remote Start.....	98		
Seats.....	98		
Starting System.....	99		
Steering System.....	99		
Tire Mobility Kit.....	99		

Index

Load Limit.....	172
Special Loading Instructions for Owners of Pick-up Trucks and Utility-type Vehicles.....	176
Vehicle Loading - with and without a Trailer.....	172
Locking and Unlocking.....	56
Activating Intelligent Access	57
Autolock Feature.....	58
Auto Relock.....	58
Battery Saver.....	60
Illuminated Entry.....	60
Illuminated Exit.....	60
Key Blade.....	59
Luggage Compartment.....	60
Power Door Locks.....	56
Remote Control.....	56
Smart Unlocks	58
Lug Nuts	
See: Changing a Road Wheel.....	264

M

Maintenance.....	210
General Information.....	210
Manual Climate Control.....	102
Manual Seats.....	111
Manual Transmission Fluid Check.....	220
Manual Transmission.....	136
Parking Your Vehicle.....	137
Recommended Shift Speeds.....	136
Reverse.....	137
Using the Clutch.....	136
Memory Function.....	112
Easy Entry and Exit Feature.....	113
Linking a PreSet Position to your Remote Control or Intelligent Access Key Fob.....	113
Saving a PreSet Position.....	112
Message Center	
See: Information Displays.....	83
Mirrors	
See: Heated Windows and Mirrors.....	107
See: Windows and Mirrors.....	73
Mobile Communications Equipment.....	14
Motorcraft Parts - 2.3L EcoBoost™	273
Motorcraft Parts - 3.7L.....	274

Motorcraft Parts - 5.0L.....	275
MyKey Troubleshooting.....	55
MyKey™	51
Principle of Operation.....	51

N

Navigation.....	382
cityseeker.....	389
Destination Mode.....	384
Map Mode.....	382
Navigation Map Updates.....	390
Navigation Menu.....	387
SiriusXM Traffic and Travel Link.....	390
Waypoints.....	388
Normal Scheduled Maintenance.....	425
Intelligent Oil-Life Monitor™	425
Normal Maintenance Intervals.....	426

O

Oil Check	
See: Engine Oil Check.....	215
Opening and Closing the Hood.....	210
Closing the Hood.....	211
Opening the Hood.....	210
Opening the Convertible Top.....	182
Using the Tonneau Caps.....	183
Ordering Additional Owner's Literature.....	198
Obtaining a French Owner's Manual.....	199

P

Parking Aids.....	150
Principle of Operation.....	150
Parking Brake.....	143
All Vehicles.....	143
Vehicles With Automatic Transmission.....	143
Vehicles with Manual Transmission.....	143
Passive Anti-Theft System.....	62
SecuriLock.....	62
PATS	
See: Passive Anti-Theft System.....	62
Perchlorate.....	11

Index

Personal Safety System™.....	36	Remote Start.....	108
How Does the Personal Safety System		Automatic Settings.....	108
Work?.....	36	Repairing Minor Paint Damage.....	235
Phone.....	377	Replacement Parts	
During a Phone Call.....	380	Recommendation.....	12
Making Calls.....	379	Collision Repairs.....	12
Pairing Your Cell Phone for the First		Scheduled Maintenance and Mechanical	
Time.....	377	Repairs.....	12
Phone Menu.....	378	Warranty on Replacement Parts.....	12
Receiving Calls.....	380	Replacing a Lost Key or Remote	
Smartphone Connectivity.....	381	Control.....	50
Text Messaging.....	381	Reporting Safety Defects (Canada	
Post-Crash Alert System.....	192	Only).....	199
Power Door Locks		Reporting Safety Defects (U.S.	
See: Locking and Unlocking.....	56	Only).....	199
Power Seats.....	111	Roadside Assistance.....	188
Power Lumbar.....	112	Vehicles Sold in Canada: Getting Roadside	
Power Steering Fluid Check.....	221	Assistance.....	189
Power Windows.....	73	Vehicles Sold in Canada: Roadside	
Accessory Delay.....	73	Assistance Program Coverage.....	189
Bounce-Back.....	73	Vehicles Sold in Canada: Using Roadside	
One-Touch Down.....	73	Assistance.....	189
One-Touch Up.....	73	Vehicles Sold in the United States: Getting	
Protecting the Environment.....	15	Roadside Assistance.....	188
R		Vehicles Sold in the United States: Using	
Rear Axle.....	141	Roadside Assistance.....	188
Rear Parking Aid.....	150	Roadside Emergencies.....	188
Obstacle Distance Indicator.....	151	Running-In	
Rear Seats.....	113	See: Breaking-In.....	185
Accessing the Rear Seats.....	113	Running Out of Fuel.....	128
Second Row Split-Folding Rear Seat	114	Adding Fuel From a Portable Fuel	
Rear View Camera.....	151	Container.....	129
Using the Rear View Camera System.....	152	Filling a Portable Fuel Container.....	129
Rear View Camera		S	
See: Rear View Camera.....	151	Safety Canopy™ - Coupe.....	43
Recommended Towing Weights.....	178	Safety Precautions.....	127
Refueling.....	130	Satellite Radio.....	302
System Warnings.....	131	Satellite Radio Electronic Serial Number	
Remote Control.....	47	(ESN).....	303
Car Finder.....	49	Satellite Radio Reception Factors.....	303
Intelligent Access Key.....	47	SIRIUS® Satellite Radio Service.....	303
Memory Feature.....	50	Troubleshooting.....	304
Remote Start.....	49	Scheduled Maintenance Record.....	430
Replacing the Battery.....	48	Scheduled Maintenance.....	422
Sounding a Panic Alarm.....	49	Seatbelt Extension.....	35
Using the Key Blade.....	47		

Index

Seatbelt Reminder.....	33
Belt-Minder™.....	33
Seatbelts.....	29
Principle of Operation.....	29
Seatbelt Warning Lamp and Indicator	
Chime.....	32
Conditions of operation.....	33
Seats.....	109
Security.....	62
Settings.....	393
911 Assist.....	398
Bluetooth.....	395
Clock.....	394
Display.....	404
General.....	402
Media Player.....	394
Mobile Apps.....	401
Navigation.....	399
Phone.....	395
Radio.....	398
Sound.....	393
Valet Mode.....	405
Vehicle.....	403
Voice Control.....	405
Wi-Fi.....	403
Side Airbags.....	41
Sitting in the Correct Position.....	109
Snow Chains	
See: Using Snow Chains.....	259
Special Notices.....	12
Additional Warranty Information.....	12
New Vehicle Limited Warranty.....	12
On Board Diagnostics Data Link	
Connector.....	13
Special Instructions.....	13
Special Operating Conditions Scheduled	
Maintenance.....	428
Exceptions.....	429
Speed Control	
See: Cruise Control.....	155
Stability Control.....	146
Principle of Operation.....	146
Starting a Gasoline Engine.....	123
Automatic Engine Shutdown.....	124
Failure to Start.....	124
Fast Restart.....	124
Guarding Against Exhaust Fumes.....	125
Important Ventilating Information.....	125
Stopping the Engine When Your Vehicle is	
Moving.....	125
Stopping the Engine When Your Vehicle is	
Stationary.....	125
Starting and Stopping the Engine.....	122
General Information.....	122
Steering.....	167
Electric Power Steering.....	167
Steering Wheel Lock.....	123
Steering Wheel.....	64
Storage Compartments.....	121
Sun Visors.....	76
Illuminated Vanity Mirror.....	76
Supplementary Restraints System.....	37
Principle of Operation.....	37
Symbols Glossary.....	7
SYNC™ 3.....	344
General Information.....	344
SYNC™ 3 Troubleshooting.....	405
SYNC™ Applications and Services.....	322
911 Assist.....	322
SYNC Mobile Apps.....	324
SYNC™.....	306
General Information.....	306
SYNC™ Troubleshooting.....	336

T

Technical Specifications	
See: Capacities and Specifications.....	271
The Better Business Bureau (BBB) Auto	
Line Program (U.S. Only).....	196
Tire Care.....	244
Glossary of Tire Terminology.....	246
Information About Uniform Tire Quality	
Grading.....	244
Information Contained on the Tire	
Sidewall.....	247
Temperature A B C.....	245
Traction AA A B C.....	245
Treadwear.....	245
Tire Inflation When Punctured	
See: Tire Sealant and Inflator Kit.....	238
Tire Pressure Monitoring System.....	260
Changing Tires With a Tire Pressure	
Monitoring System.....	261
Understanding Your Tire Pressure	
Monitoring System.....	261

Index

Tire Repair Kit	
See: Tire Sealant and Inflator Kit.....	238
Tire Sealant and Inflator Kit.....	238
First Stage: Inflating the Tire with Sealing Compound and Air.....	240
General Information.....	239
Second Stage: Checking Tire Pressure.....	242
Tips for Use of the Kit.....	239
What to Do After the Tire has Been Sealed.....	242
What to do When a Tire Is Punctured.....	240
Tires	
See: Wheels and Tires.....	238
Towing a Trailer.....	177
Load Placement.....	177
Towing the Vehicle on Four Wheels.....	180
Emergency Towing.....	180
Recreational Towing.....	181
Towing.....	177
Traction Control.....	145
Principle of Operation.....	145
Transmission Code Designation.....	277
Transmission.....	136
Transporting the Vehicle.....	192
Type Approvals.....	464
RF Certification Logos for Tire Pressure Monitoring Sensor(s).....	464
U	
Under Hood Overview - 2.3L EcoBoost™.....	212
Under Hood Overview - 3.7L.....	213
Under Hood Overview - 5.0L.....	214
Universal Garage Door Opener.....	116
HomeLink Wireless Control System.....	116
USB Port.....	305
Using Adaptive Cruise Control.....	156
Automatic Cancellation.....	159
Blocked Sensor.....	160
Canceling the Set Speed.....	158
Changing the Set Speed.....	158
Detection Issues.....	159
Following a Vehicle.....	157
Hilly Condition Usage.....	159
Overriding the Set Speed.....	158
Resuming the Set Speed.....	158
Setting the Adaptive Cruise Speed.....	156
Setting the Gap Distance.....	157
Switching Adaptive Cruise Control Off.....	159
Switching Adaptive Cruise Control On.....	156
Switching to Normal Cruise Control.....	161
System Not Available.....	160
Using Cruise Control.....	155
Switching Cruise Control Off.....	155
Switching Cruise Control On.....	155
Using MyKey With Remote Start Systems.....	55
Using Snow Chains.....	259
Using Stability Control.....	147
Electronic Stability Control	147
Line Lock.....	148
Using Summer Tires.....	259
Using SYNC™ With Your Media Player.....	327
Accessing Your USB Song Library.....	331
Bluetooth Devices and System Settings.....	333
Connecting Your Digital Media Player to the USB Port.....	327
Media Menu Features.....	330
Media Voice Commands.....	328
USB 2.....	333
Voice Commands for Audio Sources.....	334
Using SYNC™ With Your Phone.....	310
Accessing Features through the Phone Menu.....	315
Accessing Your Phone Settings.....	318
Bluetooth Devices.....	319
Making Calls.....	314
Pairing a Phone for the First Time.....	311
Pairing Subsequent Phones.....	312
Phone Options during an Active Call.....	314
Phone Voice Commands.....	312
Receiving Calls.....	314
System Settings.....	320
Text Messaging.....	316
Using Traction Control.....	145
Switching the System Off	145
System Indicator Lights and Messages.....	145

Index

Using Voice Recognition.....	308	Engine Coolant Temperature.....	80
Audio Voice Commands.....	357	Engine Oil.....	80
Climate Voice Commands.....	358	Fasten Safety Belt.....	80
Initiating a Voice Session.....	308	Front Airbag.....	80
Mobile App Voice Commands.....	360	Front Fog Lamps.....	80
Navigation Voice Commands.....	359	Heads Up Display.....	80
Phone Voice Commands.....	358	High Beam.....	81
SiriusXM Traffic and Travel Link Voice Commands.....	361	Low Fuel Level.....	81
System Interaction and Feedback.....	309	Low Tire Pressure Warning.....	81
Voice Settings Commands.....	361	Parking Lamps.....	81
Utilizing the Mediation/Arbitration Program (Canada Only).....	197	Service Engine Soon.....	81
V		Stability Control.....	81
Vehicle Care.....	230	Stability Control Off.....	82
General Information.....	230	Washer Fluid Check.....	222
Vehicle Certification Label.....	277	Washers	
Vehicle Identification Number.....	276	See: Cleaning the Exterior.....	231
Vehicle Storage.....	235	See: Wipers and Washers.....	66
Battery.....	236	Waxing.....	232
Body.....	236	Welcome Lighting.....	71
Brakes.....	236	Pony Projection Lights.....	71
Cooling system.....	236	Wheel Nuts	
Engine.....	236	See: Changing a Road Wheel.....	264
Fuel system.....	236	Wheels and Tires.....	238
General.....	236	Technical Specifications.....	270
Miscellaneous.....	237	Windows and Mirrors.....	73
Removing Vehicle From Storage.....	237	Windshield Washers.....	67
Tires.....	236	Windshield Wipers.....	66
Ventilation		Intermittent Wipe.....	66
See: Climate Control.....	102	Speed Dependent Wipers.....	66
VIN		Wiper Blades	
See: Vehicle Identification Number.....	276	See: Checking the Wiper Blades.....	224
Voice Control.....	65	Wipers and Washers.....	66
W			
Warning Lamps and Indicators.....	79		
Adaptive Cruise Control.....	79		
Anti-Lock Braking System.....	79		
Battery.....	79		
Blind Spot Monitor.....	79		
Brake System.....	79		
Cruise Control.....	80		
Direction Indicator.....	80		
Door Ajar.....	80		