

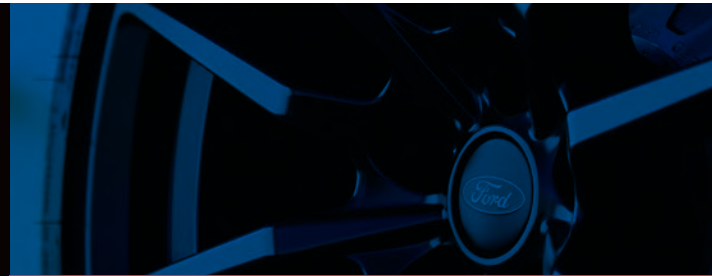

This Supplement is not intended to replace your vehicle Owner's Manual which contains more detailed information concerning the features of your vehicle, as well as important safety warnings designed to help reduce the risk of injury to you and your passengers. Please read your entire Owner's Manual carefully as you begin learning about your new vehicle and refer to the appropriate sections when questions arise.

All information contained in this supplement was accurate at the time of duplication. We reserve the right to change features, operation and/or functionality of any vehicle specification at any time. Your Ford dealer is the best source for the most current information. For detailed operating and safety information, please consult your Owner's Manual.



FORD PERFORMANCE



March 2017
Third Printing
Mustang Supplement
Shelby GT350
Litho in USA



HR3J 19A285 AC



owner.ford.com (U.S.)



ford.ca (Canada)



**2017 SHELBY GT350®
MUSTANG SUPPLEMENT**

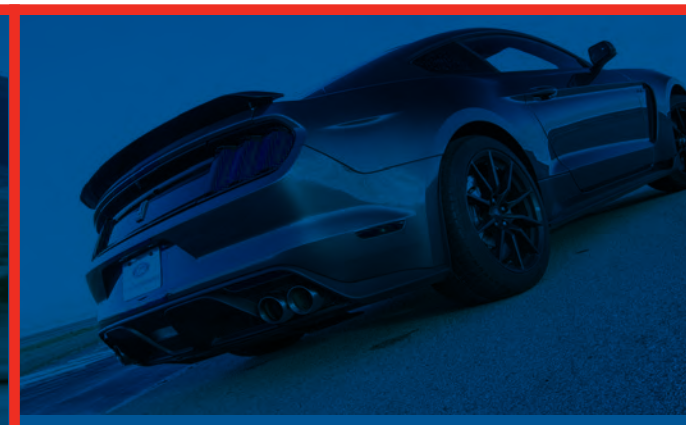
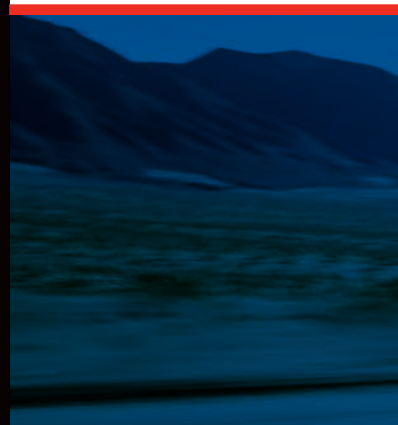

The information contained in this publication was correct at the time of going to print. In the interest of continuous development, we reserve the right to change specifications, design or equipment at any time without notice or obligation. No part of this publication may be reproduced, transmitted, stored in a retrieval system or translated into any language in any form by any means without our written permission. Errors and omissions excepted.

© Ford Motor Company 2017

All rights reserved.

Part Number: 201603 20170106204517

Table of Contents

Introduction

About This Supplement.....3

At a Glance

At a Glance.....6

Child Safety

Installing Child Restraints.....10

Steering Wheel

Audio Control.....12

Voice Control.....12

Lighting

Daytime Running Lamps.....13

Instrument Cluster

Gauges.....14

Information Displays

General Information.....15

Fuel and Refueling

Fuel Quality.....23

Refueling.....23

Transmission

Manual Transmission.....24

Brakes

General Information.....26

Stability Control

Using Stability Control.....27

Towing

Towing a Trailer.....29

Transporting the Vehicle.....29

Driving Hints

Breaking-In.....33

Driving Through Water.....33

Fuses

Fuse Specification Chart.....34

Maintenance

Under Hood Overview.....35

Engine Oil Check.....36

Changing the Engine Oil and Oil
Filter.....36

Engine Coolant Check.....36

Changing the Wiper Blades.....38

Changing the Engine Air Filter.....38

Vehicle Care

Cleaning the Exterior.....40

Cleaning the Engine.....40

Cleaning the Windows and Wiper
Blades.....40

Wheels and Tires

Wheels.....41

Tires.....42

Using Winter Tires.....43

Capacities and Specifications

Motorcraft Parts.....44

Technical Specifications.....44

Warranty Terms and Conditions

Base Warranty.....46

Scheduled Maintenance

General Maintenance Information.....47

Normal Scheduled Maintenance.....50

Table of Contents

Special Operating Conditions Scheduled Maintenance.....	53
Scheduled Maintenance Record.....	55

Introduction

ABOUT THIS SUPPLEMENT

Congratulations on your decision to purchase or lease the latest from Ford Performance. If you have owned or leased a Ford Performance product in the past, we are glad you are back. If this is your first

Ford Performance vehicle, welcome to the Ford Performance family! We are confident that our dedication to performance, quality, craftsmanship and customer service will provide many miles of exhilarating, safe and comfortable driving in your new vehicle.



E211568

Your choice of a Ford Performance product is an intelligent and informed one. Ford Performance strives to build engaging vehicles that involve the driver in every aspect of the driving experience. Although performance is at the heart of every Ford Performance vehicle, we go much further. Our goal is to deliver a comprehensive, complete vehicle, sweating the details such as the sound of the exhaust, the quality of the interior materials, and the functionality and the comfort of the seats, to make sure that the driver enjoys not only exceptional performance, but an

outstanding driving environment as well. In your Ford Performance vehicle, that philosophy is expressed by a sophisticated powertrain, outstanding chassis dynamics and significant interior and exterior enhancements.

This supplement complements your Mustang Owner's Manual and provides information specific to your Ford Performance vehicle. By referring to the pages listed in this supplement, you can identify those features, recommendations

Introduction

and specifications unique to your new vehicle. If there are any discrepancies between this supplement and the Mustang Owner's Manual, this supplement shall supersede the information found in the Mustang Owner's Manual.

If you have any questions or concerns regarding your Ford Performance vehicle, please call the Ford Performance Info Center at 1-800-367-3788.

SVT History

The Ford Special Vehicle Team (SVT) was established in 1991 to polish the Ford Oval by creating low-volume, factory-produced vehicles designed for those select few whose idea of driving is a high-powered, passionate experience – not just a means of getting from point A to point B.

In a move to support this spirited enthusiasm, Ford Motor Company carefully integrated the wide array of talent in the company into a small, cross-functional group of engineers and product planners, housed together under one roof with a common mission: to create vehicles specifically designed to meet the unique needs and desires of the knowledgeable driving enthusiast.

More than 250,000 SVT vehicles were produced since the 1993 model year. These include the SVT Mustang Cobra and the Cobra R, the SVT F-150 Lightning, the SVT Contour, the SVT Focus, Ford GT, Shelby GT500, GT500KR and the F-150 SVT Raptor.

Team RS History

TeamRS traces its roots back nearly 60 years from the Lotus Ford Cortina and Twin Cam Escorts of the mid 1960's, through the first RS branded Escorts of the 1970's to the founding of Special Vehicle Engineering (SVE) in 1980. Through the 1980s and 90s, SVE delivered a breadth of vehicles from exciting XR and RS branded road going performance cars through homologation specials such as the iconic Sierra Cosworth RS500. The first ST (Sport Technology) vehicle appeared in 1996 as the ST24 Mondeo. The first collaboration between Ford's European and North American performance teams appeared in 2002 as the ST170 in Europe and SVT Focus in North America. In 2003, TeamRS replaced SVE in Europe as performance car and motorsport personnel were brought together as one team. TeamRS subsequently created the 2004 Fiesta ST, 2005 Focus ST and 2009 Focus RS.

Ford Performance

SVT and Team RS officially began working together as one team in 2009. In 2015, these two teams, along with Ford Racing, were formally combined establishing Ford Performance as a single team responsible for all performance and racing oriented products and activities worldwide at Ford Motor Company. Your Ford Performance vehicle represents the best of what Ford Performance has to offer from around the globe. Your vehicle has been designed and developed with the four hallmarks of Ford Performance in mind: Performance, Substance, Exclusivity and Value. We are proud and passionate about what we do, and we are glad you have made us your choice.

Introduction



E211570

At a Glance

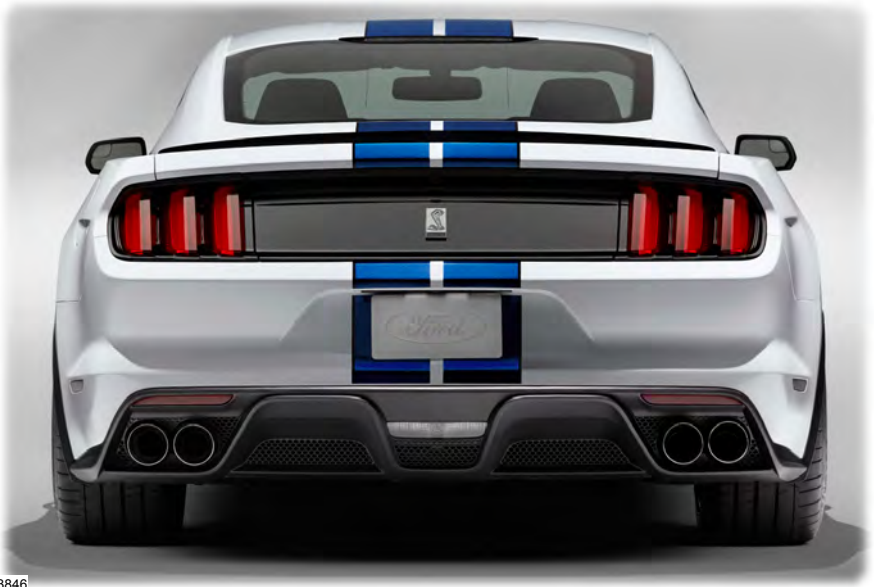

E193846

Powertrain

- 5.2L Flat Plane Crank engine.
- Large bore electronic throttle body.
- Cold air intake and filter.
- Tubular exhaust manifolds.
- High flow dual exhaust with X-pipe and dual mode mufflers.
- Unique R exhaust with reduced back pressure and lighter weight.
- Tremec 3160 6-speed manual transmission.
- Dual disc clutch.
- Dual mass flywheel.
- 3.73 Torsen differential with GT350 specific bias ratios.
- Transmission, differential and engine oil coolers.

Chassis

- Electric power assisted steering
- 6-piston front, 4-piston rear Brembo calipers, and front cooling ducts.
- Two-piece front and rear rotors.
- MagneRide dampers and sensors.
- Lightweight tower to tower brace.

Exterior

- Unique aero (splitter, grilles, underbody shield, diffuser, spoiler, air curtains).
- Aluminum hood with center air extractor.
- Aluminum front fenders with air extractors.
- Aluminum front bumper.
- Lightweight aluminum wheels.
- Carbon fiber wheels (R model only).

At a Glance

- Michelin Super Sport tires.
 - Michelin Pilot Sport Cup 2 tires (R model only).
 - Optional over the top stripes.
- Interior**
- SYNC with MyFord (4 inch screen).
 - SYNC 3 (8 inch screen) with navigation (if equipped).
 - Launch Control.
 - Drive Modes Control (Normal, Sport, Weather, Track, Dragstrip).
 - Performance Shift Indicator.
 - Driver and steering mode control.
 - Unique instrument panel and gauges.
 - 9-speaker system with satellite radio (if equipped).
 - Dual zone electronic climate control (if equipped).
 - Recaro seats.
 - Optional 6-way power climate controlled leather seats (Convenience package only).
 - Rear seat delete (R model only).
 - Lightweight battery.

Vehicle Specifications

Item	Description	
Transmission	Tremec 6-speed manual with 215 millimeter dual clutch and dual mass flywheel	
Driveshaft rear axle	3.73	
Gear ratios	Gear	Ratio
	1st	3.25
	2nd	2.23
	3rd	1.61
	4th	1.24
	5th	1.00
	6th	0.63
	Reverse	2.95

At a Glance

Engine Specifications

Item	Description
Configuration	90 degree V8
Bore x stroke	94mm bore x 93mm stroke (3.70 in. x 3.66 in.)
Displacement	5163 cubic centimeters (315 cubic inches)
Compression ratio	12:1
Horsepower	526
Torque	429 ft-lbs
Redline	8250 RPM*
Valvetrain	Overhead cams - roller finger followers
Ignition	Coil on plug
Throttle body	87 mm (3.4 in.)
Pistons	Forged aluminum
Crankshaft	Forged steel flat plane
Connecting rods	Forged steel I-beam
Induction	Naturally aspirated cold air induction
Exhaust system	High flow dual exhaust with X-pipe and dual mode mufflers.

*Redline is limited to 8000 RPM until the engine oil temperature exceeds 190°F (88°C).

Suspension Specifications

Item	Description
Front suspension	MacPherson strut, double ball-joint
Rear suspension	Multi-link
Front spring rate	GT350 34 N/mm (194 lb/in)
	GT350R 42 N/mm (240 lb/in)

At a Glance

Item	Description
Rear spring rate	GT350 160 N/mm (914 lb/in)
	GT350R 160 N/mm (914 lb/in)
Front stabilizer bar	GT350 34mm DIA x 5.7mm wall (1.34 x 0.22 in)
	GT350R 34mm DIA x 5.7mm wall (1.34 x 0.22 in)
Rear stabilizer bar	GT350 22.2mm DIA x 3.9mm wall (0.87 x 0.15 in)
	GT350R 24mm DIA x 3.6mm wall (0.94 x 0.14 in) with 8mm (0.31 in) shorter arms than GT350

Child Safety

INSTALLING CHILD RESTRAINTS

Rear Seat Delete (If Equipped)

WARNING



In a crash, passengers who are unbelted are significantly more likely to be seriously injured or killed. Do not allow people to ride in any area of your vehicle that is not equipped with seats and seatbelts. Be sure everyone in your vehicle is in a seat and using a seatbelt properly.

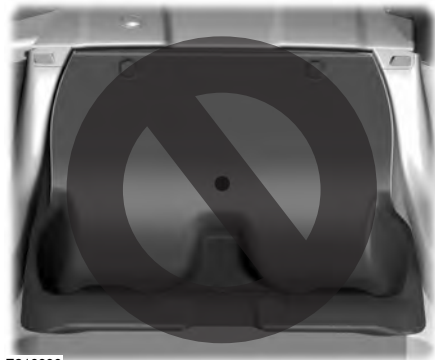

E216990

This is not a seating position. Persons or child restraints cannot be placed in the rear of the vehicle with the rear seat delete option.

Vehicles Without Rear Seats

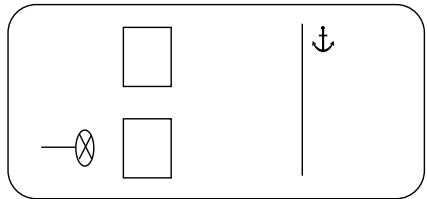

E216824

Once the child restraint has been installed using the seatbelt, you can attach the top tether strap.

Attach the tether strap only to the appropriate tether anchor as shown. The tether strap may not work properly if attached somewhere other than the correct tether anchor.

Perform the following to attach a child restraint to the tether anchor.

Route the tether strap as follows:

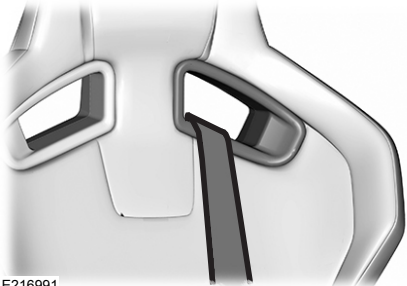

E216991

For coupe without rear seats, route the tether strap through the inboard slot of the front passenger seatback or route the tether strap over the top of the seat. A tether strap extension may be needed to reach the tether anchor.

Child Safety

If you install a child restraint and have attached the top tether strap to the proper top tether anchor, do not tighten the tether strap enough to lift the child restraint off the vehicle seat cushion when the child is seated in it. Keep the tether strap just snug without lifting the front of the child restraint. Keeping the child restraint just touching the vehicle seat gives the best protection in a severe crash.

See the Child Safety chapter in your Owner's Manual for more information.

Steering Wheel

AUDIO CONTROL (If Equipped)

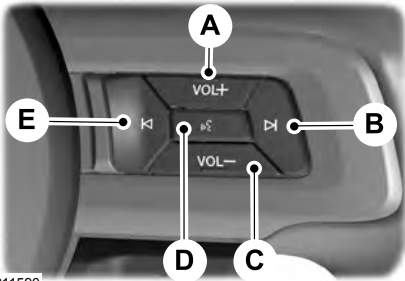

E211590

- A Volume up.
- B Seek up or next.
- C Volume down.
- D Voice recognition.
- E Seek down or previous.

- E Cruise control resume/cancel.
- F Cruise control set/decrease.

Drive Mode Control

Press any of the buttons to display a menu screen. Press the button a second time to toggle between the options.

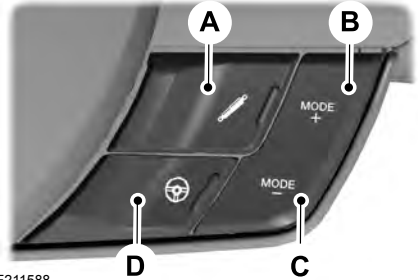

E211588

- A Damper.
- B Drive Mode +.
- C Drive Mode -.
- D Steering Effort.

VOICE CONTROL (If Equipped)

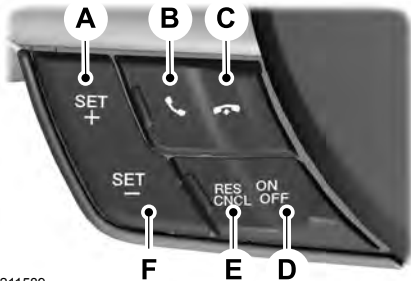

E211589

- A Cruise control set/increase.
- B Answer call.
- C End call.
- D Cruise control on/off.

Lighting

DAYTIME RUNNING LAMPS (If Equipped)

The daytime running lamps activate the headlamps, taillamps, side-marker, license plate and parking lamps at all times when the vehicle is running and the parking brake is not applied, regardless of the headlamp switch position.

Instrument Cluster

GAUGES (If Equipped)

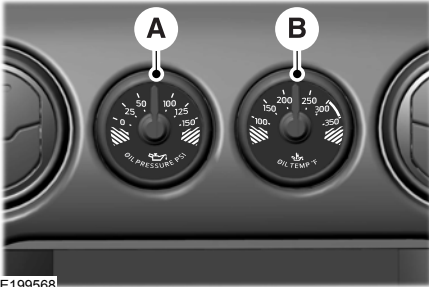

E199568

- A Oil pressure gauge - Indicates the engine oil pressure.
- B Oil temperature gauge - Indicates the engine oil temperature.

Information Displays

GENERAL INFORMATION

Drive Modes

Normal



E216082

Sport



E216083

Weather



E216084

Track



E216085

Drag Strip



E216086

Track Apps

Track Apps is a menu option accessible from the main menu in the instrument cluster and consists of the following features.

Information Displays

Status screen

Status Screen provides a snapshot of current status of Drive Mode, AdvanceTrac, Exhaust Mode, Steering Effort, Launch Control, and Dampers

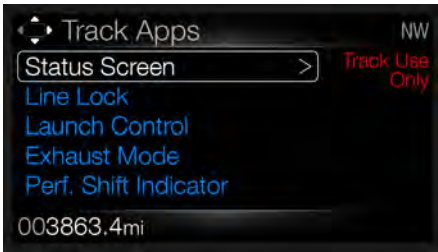

E212279



E212280

Line lock

Line Lock locks front wheels while allowing the rear brakes to spin freely. Line Lock is automatically selected when Drag Strip Drive mode is selected.

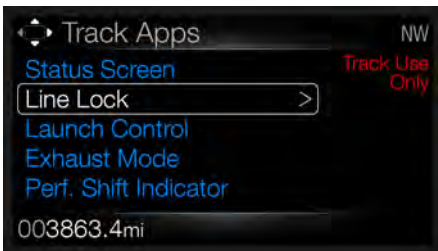

E212281

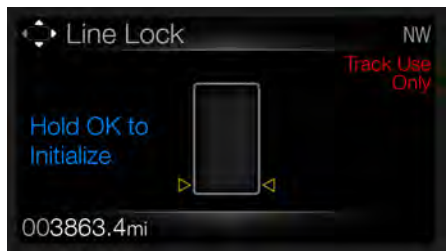

E212282

Launch control (LC)

Minimizes wheel slip during standing start. Feature is enabled or disabled using the 5-way switches or through the LC button on the center stack. RPM setting allows user to set the Launch RPM value within the allowable range.

Information Displays

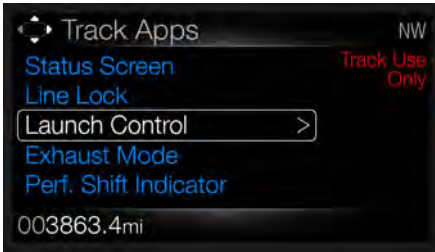

E212283

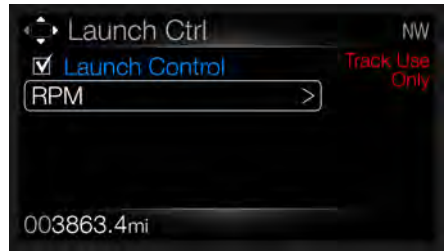

E212284

Exhaust mode

Exhaust mode is defaulted between Normal or Sport based on the selected Drive mode. The user can override the default setting using the menu option or using the toggle switch on premium models.

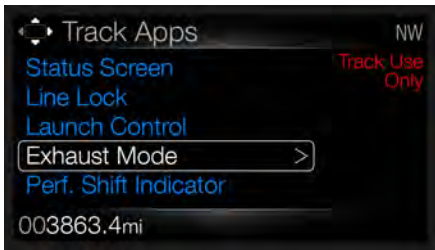

E212286



E212287

Performance shift Indicator

The performance shift Indicator consists of a light bar located on the dash that reflects an image onto the windshield displaying a row of LEDs representing engine RPM. Allows user to set shift point within allowable RPM range in increments of 100 RPM. Allows user to enable or disable associated shift tone (based on set shift point). Allows user to set mode between Off, Tach, Track, & Drag (changes the way the LEDs light up). Allows user to set the light intensity (intensity also automatically adjusts between day time and night time).

Information Displays

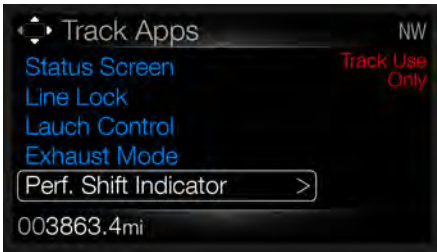

E212288



E212289

Accelerometer

Displays your vehicle's rate of acceleration or deceleration (see the main owner manual for more detail).

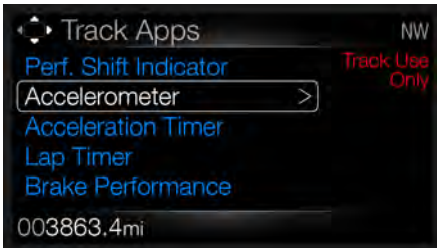

E212290



E212428

Acceleration timer

Displays your vehicle's straight line performance.

Information Displays



E212291



E212292

Lap timer

Allows up to three different track lengths to be set and have lap times recorded for each.
Calculates average speed based on driver-entered track distance and driver-measured lap times.
Allows data to be saved for each track that has times recorded.
Saves All Time Best lap time & Average speed for each Track that has times recorded.

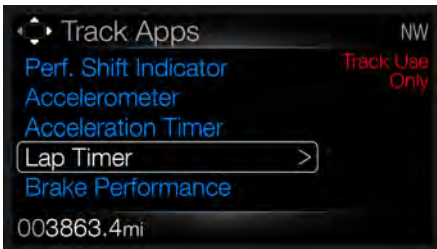

E212293



E212294

Brake performance

Displays your vehicle's rate of deceleration (see the main owner's manual for more detail).

Information Displays

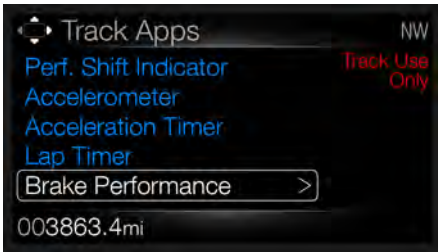

E212295

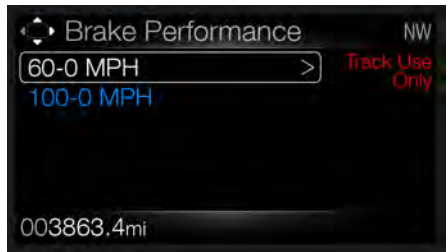

E212296

View/Clear results

View and clear the last and saved results of the acceleration timer, brake performance and all-time best.

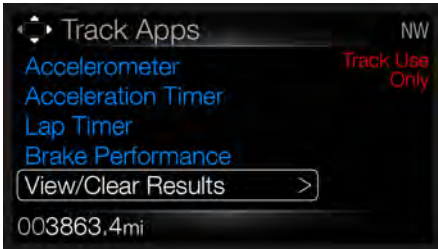

E212297



E212298

Virtual Gauges

Virtual Gauges consist of the following gauges that are available in digital display mode or Analog display mode (if equipped).

Information Displays

Digital speedometer



E212299

Displays vehicle speed in mph or km/h.

Tire pressure



E212300

Displays tire pressure by location in psi, bar, or kPa.

Air inlet temperature



E212429

Displays the temperature of the air in the cold air inlet tube.

Air/Fuel ratio



E212430

Displays the current air to fuel mixture in the engine.

Voltage



E212431

Displays the vehicle battery voltage.

Information Displays

Cylinder head temperature



E224200

Displays the engine cylinder head temperature.

Engine oil temperature



E212301

Displays the engine oil temperature.

Engine oil pressure



E212302

Displays the engine oil pressure.

Transmission oil temperature



E212303

Displays the transmission oil temperature.

Axle oil temperature



E212304

Displays the axle oil temperature.

Fuel and Refueling

FUEL QUALITY

Choosing the Right Fuel

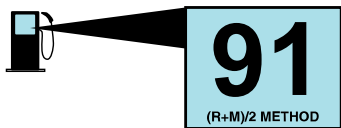

E185193

Use only premium unleaded gasoline with a minimum pump (R+M)/2 octane rating of 91. For optimal performance, use premium unleaded gasoline with an octane rating of 93 or higher.

The use of the correct fuel is an important part of the proper maintenance of your vehicle, and a condition of the vehicle Warranty. For this vehicle, the use of gasoline with an octane level of 91 or higher is required. The use of gasoline with an octane rating lower than 91 will invalidate the vehicle Warranty. It can degrade vehicle performance and lead to severe mechanical damage.

Note: *Use of any fuel other than those recommended can impair the emission control system and cause a loss of vehicle performance.*

Do not use:

- Diesel fuel.
- Fuels containing kerosene or paraffin.
- Fuel containing more than 15% ethanol or E85 fuel.
- Fuels containing methanol.
- Fuels containing metallic-based additives, including manganese-based compounds.

- Fuels containing the octane booster additive, methylcyclopentadienyl manganese tricarbonyl (MMT).
- Leaded fuel (using leaded fuel is prohibited by law).

The use of fuels with metallic compounds such as methylcyclopentadienyl manganese tricarbonyl (commonly known as MMT), which is a manganese-based fuel additive, will impair engine performance and affect the emission control system.

Do not be concerned if the engine sometimes knocks lightly. However, if it knocks heavily under most driving conditions while you are using fuel with the recommended octane rating, contact an authorized dealer to prevent any engine damage.

REFUELING

Octane Recommendations

Premium unleaded gasoline with an (R+M)/2 octane rating of 91 or higher is required. Ford Performance recommends using unleaded gasoline with octane rating of 93 or higher for optimal performance of this vehicle.

Recommended fuel is an important part of the proper maintenance and optimal performance of this vehicle. The use of gasoline with an octane rating lower than 91 can lead to severe mechanical damage to your vehicle, may degrade vehicle performance, and may affect your warranty coverage.

Note: *This vehicle is not E85 compatible. Use only premium unleaded fuel.*

Transmission

MANUAL TRANSMISSION



E193849

Using the Clutch

The manual transmission has a starter interlock that prevents cranking the engine unless the clutch pedal is fully pressed.

To start the vehicle:

1. Make sure the parking brake is fully set.
2. Press the clutch pedal to the floor, then put the gearshift lever in the neutral position.
3. Start the engine, then press the brake pedal and release the parking brake.
4. Move the gearshift lever to first gear, then slowly release the clutch pedal while slowly pressing on the accelerator.

Note: *During each shift, the clutch pedal must be fully pressed to the floor and the accelerator fully released. Failure to follow this may cause increased shift efforts, prematurely wear transmission components, or cause gear clash or damage to the transmission. Make sure the floor mat is properly positioned so it does not interfere with the full extension of the clutch pedal.*

Note: *If you attempt to shift when the drive wheels are spinning with a loss of traction, it is possible to cause damage to the transmission. Do not attempt to shift when the drive wheels do not have traction.*

Do not drive with your foot resting on the clutch pedal or use the clutch pedal to hold your vehicle at a standstill while waiting on a hill. These actions will reduce the life of the clutch.

Your vehicle is equipped with a twin disc clutch. Due to the high performance of the powertrain, a certain amount of noise from the transmission is normal.

Clutch Protection

Your vehicle is equipped with an electronic powertrain feature to reduce clutch damage. When excessive clutch slip is detected at a high power level, the powertrain control module will limit torque to reduce damage to the clutch. Full power is restored as soon as the clutch is fully engaged. This feature is calibrated in a way that does not interfere with normal driving and does not impede maximum acceleration capability.

Recommended Shift Speeds for Maximum Fuel Economy

Upshift according to the following chart:

Shift from	Recommended speed
1 - 2	13 mph (21 km/h)
2 - 3	24 mph (39 km/h)
3 - 4	31 mph (50 km/h)
4 - 5	39 mph (63 km/h)
5 - 6	43 mph (69 km/h)

Transmission

Operating at High Speeds and on Track Days

Your vehicle is capable of sustained high speeds and track day driving.

Note: *Obey all traffic laws and only operate your vehicle at locations designed to do so safely.*

Before operating your vehicle at high speeds, follow these guidelines.

- Verify your tires have the correct tire pressures (see Tires in this supplement).
- Inspect wheels and tires for wear and damage. Replace any damaged wheels or tires.
- Do not operate your vehicle at high speeds with more than two passengers or while carrying cargo.
- Your vehicle has electronic controls to reduce power and/or limit RPM to reduce powertrain temperatures if required.

Brakes

GENERAL INFORMATION

Your vehicle has a brake system designed for high speed and superior fade resistance. You may notice occasional brake squeal and elevated levels of brake dust. This is normal and does not affect brake system performance.

Front Brake System

SHW® Multi-piece brake disc with the following features:

- Cross-drilled iron brake ring with directional vent design, including a large effective radius and swept area. Specially designed for storing and dissipating braking energy during track usage.
- Aluminum hat for significant weight savings.
- Floating stainless steel pin design maintains excellent on-road performance while allowing radial expansion during track usage.

Aluminum Knuckle with Heavy-Duty Wheel Bearing

- Aluminum knuckle designed for high stiffness while reducing weight.
- Heavy-duty front wheel bearing designed for track usage.

Six-Piston Monobloc Brembo® caliper with the following features:

- Large pad area maintains excellent on-road performance while providing fade-free performance on the track, without the need for special friction materials.
- Staggered piston design provides even pad wear on the street and track.
- Fixed bridge and radial mount provides maximum caliper stiffness for excellent pedal feel at minimum weight.

Rear Brake System

SHW® Multi-piece brake disc with the following features:

- Cross-drilled iron brake ring with vented design and large effective radius. Specially designed for storing and dissipating braking energy during track usage.
- Aluminum hat for significant weight savings with iron lining for parking brake function.
- Floating stainless steel pin design maintains excellent on-road performance while allowing radial expansion during track usage.

Four-Piston Monobloc Brembo® caliper with the following features:

- Staggered piston design provides even pad wear on the street and track.
- Reduced drag compared to sliding calipers, especially during track usage.
- Consistent appearance theme with front caliper.

Drum-In-Hat Parking Brake

- Decouples parking brake function from rear caliper, eliminating caliper design compromises.
- Provides superior parking brake performance and feel for hand brake lever.

Stability Control

USING STABILITY CONTROL

The traction and stability control enhancement system provides different modes of operation for various driving conditions. The system integrates braking, steering and powertrain systems using anti-lock brakes, traction control, electric power-assisted steering and Launch Control to optimize the performance for all driving conditions.

Integrated Driver Control

There are five drive modes that are accessed by Mode + and Mode – buttons located on the steering wheel.

Each mode sets predefined defaults for:

- Engine controls.
- Brake controls.
- Steering effort.
- Exhaust mode.
- Dampers.
- Launch control.

Control Mode Selector Switch	
Normal	Used for normal on road driving.
Sport	Used for spirited on road driving. Vehicle response tuned for on road performance.
Weather	Used for lower traction, wet conditions on public roads. The traction and stability control systems are extremely sensitive to low traction situations. This helps reduce wheel spin and side to side vehicle movement.
Track	Used by skilled drivers for spirited and aggressive driving while at a track. The traction and stability control system intervention is reduced to not interfere with a skilled driver while retaining some system aids.
Drag Strip	Used at a drag strip. You can use in conjunction with launch control. Allows for optimum traction at low speeds, transitioning to enhanced stability at high speeds.

You can enable launch control on your vehicle only when:

- Your vehicle is in Drag Strip mode.
- Your vehicles coolant temperature is more than 170°F (77°C).

Note: *Line lock can only be enabled if Launch Control is available. See the Stability Control chapter in your Owner's Manual for more information.*

Stability Control

Launch Control Switch	
On	Off
Manages brakes and electronic throttle to optimize launch performance.	Default at start-up

Traction Control Off	
On	Off
Default at start-up	Traction and stability control button pressed momentarily. Turns off engine and brake traction control. Stability control remains enabled.

Stability and Traction Control Off	
On	Off
Default at start-up	Traction and stability control button pressed and held more than five seconds. Attributes of active mode remain except for traction and stability control which are disabled.

Towing

TOWING A TRAILER

WARNING



Your vehicle is not approved for trailer towing. Never tow a trailer with your vehicle.

TRANSPORTING THE VEHICLE

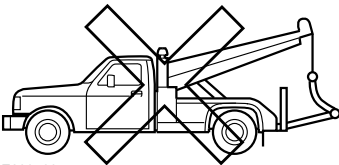
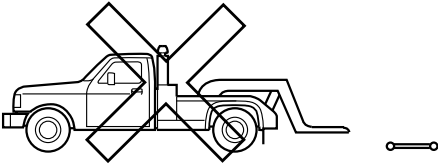
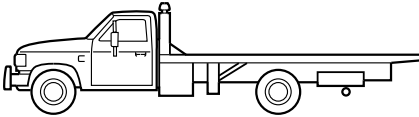

E203788

If you need to have your vehicle towed, contact your roadside assistance center or a professional towing service.

We recommend that your vehicle be towed with flatbed equipment only. When towing with a flatbed, race ramps or wood ramps must be used when loading or unloading your vehicle. Wheel baskets are required when flat bed towing.

Note: Do not tow with a slingbelt or wheel lift equipment.

Note: If the vehicle is towed by other means or incorrectly, vehicle damage may occur.

Towing

Transportation Instructions

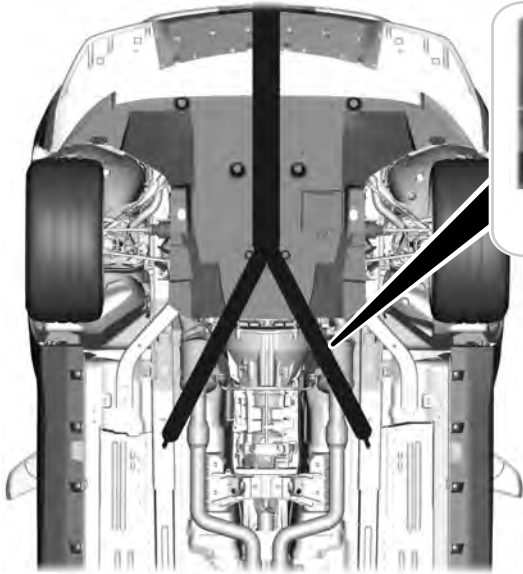

E201704

Two mini J hooks should be used when the vehicle is towed. The hooks should be attached to the oblong holes in rails as shown to winch the vehicle onto the flatbed. Use tire slings only to tie the vehicle down to the flatbed. Other methods may damage the vehicle.

Towing

Preferred Flatbed Method

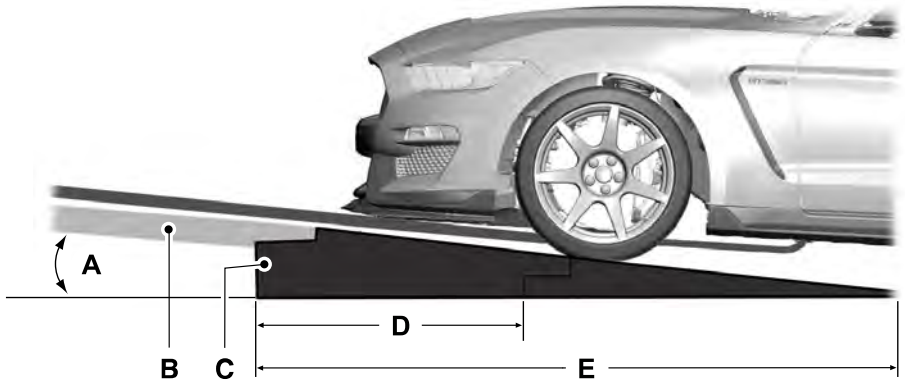

E213831

- A Seven degrees maximum.
- B Tow vehicle ramp.
- C Race ramps.
- D 30 inches (76 centimeters) minimum.
- E 70 inches (178 centimeters) minimum.

Use race ramps to load the vehicle.

The diagram illustrates the maximum ramp angle allowable to load your vehicle on a flatbed. Vehicle damage may occur with greater angles.

Ramps must be used to achieve appropriate undercarriage clearances.

Towing

Alternate Flatbed Method

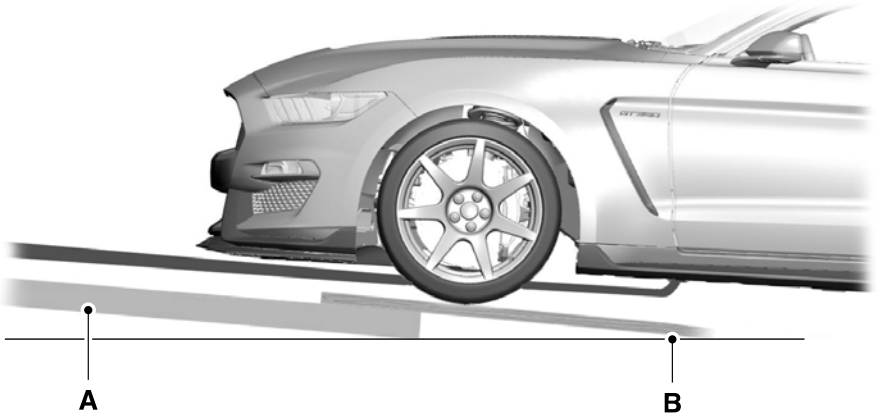

E196912

- A Tow vehicle ramp.
- B Wooden ramp.

Use 2 inch x 8 inch x 8 foot wooden ramps to load the vehicle.

The diagram illustrates the maximum ramp angle allowable to load your vehicle on a flatbed. Vehicle damage may occur with greater angles.

Blocks must be used to achieve appropriate undercarriage clearances.

Driving Hints

BREAKING-IN

Your vehicle requires a break-in period. Drive your new vehicle at least 100 mi (160 km) before performing extended wide open throttle maneuvers and at least 1,000 mi (1,600 km) before performance or competition conditions.

Note: *Vary your speed frequently in order to give the moving parts a chance to break in.*

Ground Clearance

Since ground clearance is reduced, use caution when approaching curbs or curb stops from the front and rear as vehicle damage will occur. Additionally, when crossing speed bumps or driveway curbs, Ford Performance recommends approaching at a 45 degree angle to reduce the risk of vehicle damage.

Your vehicle carries the same warranty as other Ford models. Damage caused by accidents, crashes or objects striking the vehicle (including driving through a car wash) or misuse of the vehicle, such as driving over curbs, overloading or racing is not covered under the new vehicle limited warranty. See the Warranty Guide for complete information.

DRIVING THROUGH WATER

The GT350 has aerodynamic devices attached to the underbody designed to help control airflow for superior performance. Therefore, the driver must be especially careful to avoid driving through deep or standing water. If driving through deep or standing water is unavoidable, do not exceed 10 mph (16 km/h). Never drive through water that

is higher than the bottom of the wheel rims. Water may enter through the air intake due to the vacuum generated in the engine. Damage caused by the intake of water in the engine is not covered by the warranty.

Fuses

FUSE SPECIFICATION CHART

See the Owner's Manual for your vehicle's fuse information.

Maintenance

UNDER HOOD OVERVIEW

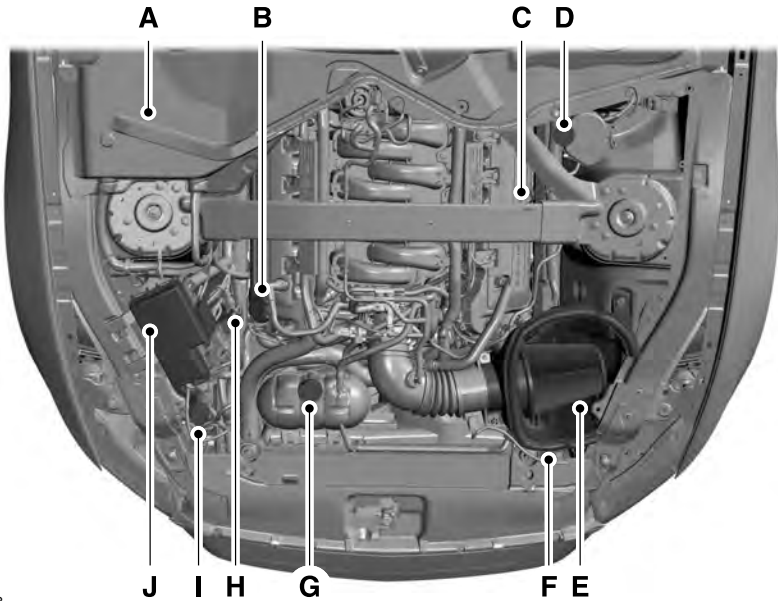

E193853

- A Battery.
- B Engine oil filler cap.
- C Engine oil dipstick.
- D Brake fluid reservoir.
- E Air filter assembly.
- F Cold air induction system.
- G Engine coolant reservoir.
- H Powertrain control module.
- I Windshield washer reservoir.
- J Power distribution box.

Maintenance

ENGINE OIL CHECK

See the scheduled maintenance information (including the "Protecting Your Investment" section) for the appropriate intervals for checking the engine oil.

1. Make sure the vehicle is on level ground.
 2. Turn the engine off and wait 15 minutes for the oil to drain into the oil pan.
 3. Set the parking brake and make sure the gearshift is securely latched in first gear.
 4. Open the hood. Protect yourself from engine heat.
 5. Locate and carefully remove the engine oil level dipstick.
 6. Wipe the dipstick clean. Insert the dipstick fully, then remove it again.
 7. Put the dipstick back in and make sure it is fully seated.
- If the oil level is between the lower and upper holes, the oil level is acceptable. **DO NOT ADD OIL.**
 - If the oil level is below the lower hole, add enough oil to raise the level within the lower and upper holes.

Engine Oil Recommendation

Use Motorcraft SAE 5W-50 full synthetic or an equivalent SAE 5W-50 full synthetic oil meeting Ford specification WSS-M2C931-B.

Do not use supplemental engine oil additives, cleaners or other engine treatments. They are unnecessary and could lead to engine damage that is not covered by Ford warranty.

Change your engine oil and filter according to the appropriate schedule listed in the scheduled maintenance information.

CHANGING THE ENGINE OIL AND OIL FILTER

1. Remove the old oil filter and dispose of properly.
2. Wipe the engine seal surface and threads with a clean rag.
3. Apply oil to the new oil filter seal.
4. Install the oil filter and torque to 22-24 Nm (16-18 ft-lb).

Note: Use only a Motorcraft FL-2069-ST oil filter for maximum performance, reliability and durability. This filter was specifically engineered for this vehicle.

Note: The use of any oil filter other than the dealer supplied oil filter may cause engine damage.

See the Engine Oil Check section in the Maintenance chapter of your Owner's Manual for information on changing the engine oil.

ENGINE COOLANT CHECK

The concentration and level of engine coolant should be checked at the mileage intervals listed in the scheduled maintenance information.

Note: Make sure that the level is between the MIN and MAX marks on the engine and coolant reservoirs.

Note: Coolant expands when it is hot. The level may extend beyond the MAX mark. If the level is at the MIN mark, add coolant immediately.

The coolant concentration should be maintained within 48% to 50%, which equates to a freeze point between -29°F (-34°C) and -35°F (-37°C).

Maintenance

Note: For best results, coolant concentration should be tested with a refractometer such as Rotunda tool 300-ROB75240 available from your dealer. Ford does not recommend the use of hydrometers or coolant test strips for measuring coolant concentrations.

Be sure to read and understand Precautions in your Owner's Manual. If the coolant has not been checked at the recommended interval, the engine coolant reservoir may become low or empty. If the reservoir is low or empty, add coolant to the reservoir. See Adding Engine Coolant in this chapter.

Note: Automotive fluids are not interchangeable. Do not use engine coolant, antifreeze or windshield washer fluid outside of its specified function and vehicle location. For more information about engine coolant, see the Maintenance chapter of the Owner's Manual.

Adding Engine Coolant

WARNINGS



Do not add coolant when the engine is hot. Steam and scalding liquids released from a hot cooling system can burn you badly. Also, you can be burned if you spill coolant on hot engine parts.



Do not put coolant in the windshield washer fluid container. If sprayed on the windshield, coolant could make it difficult to see through the windshield.



To reduce the risk of personal injury, make sure the engine is cool before unscrewing the coolant pressure relief cap. The cooling system is under pressure; steam and hot liquid can come out forcefully when the cap is loosened slightly.



Do not add coolant further than the MAX mark.

Note: Do not use stop leak pellets, cooling system sealants, or additives as they can cause damage to the engine cooling or heating systems. This damage would not be covered under your vehicle's warranty.

Note: During normal vehicle operation, the engine coolant may change color from orange to pink or light red. As long as the engine coolant is clear and uncontaminated, this color change does not indicate the engine coolant has degraded nor does it require the engine coolant to be drained, the system to be flushed, or the engine coolant to be replaced.

- DO NOT MIX different colors or types of coolant in your vehicle. Make sure the correct coolant is used. Mixing of engine coolants may harm your engine's cooling system. The use of an improper coolant may harm engine and cooling system components and may void the warranty.
- In case of emergency, a large amount of water without engine coolant may be added in order to reach a vehicle service location. In this instance, the cooling system must be drained, chemically cleaned with Motorcraft® Premium Cooling System Flush, and refilled with prediluted coolant as soon as possible. Water alone (without engine coolant) can cause engine damage from corrosion, overheating or freezing.

Note: Do not use alcohol, methanol or brine or any engine coolants mixed with alcohol or methanol antifreeze (coolant). Alcohol and other liquids can cause engine damage from overheating or freezing.

Note: Do not add extra inhibitors or additives to the coolant. These can be harmful and compromise the corrosion protection of the engine coolant.

Unscrew the cap slowly. Any pressure will escape as you unscrew the cap.

Maintenance

Add prediluted engine coolant meeting the Ford specification. See Capacities and Specifications for more information. Whenever coolant has been added, the coolant level in the coolant reservoir should be checked the next few times you drive the vehicle. If necessary, add enough prediluted coolant to bring the coolant level to the proper level.

Coolant Refill Procedure

The following procedure should be used when refilling the cooling system after it has been drained or become extremely low.

1. Remove the pressure relief cap from the coolant reservoir as previously outlined.
2. Slowly add prediluted coolant to the coolant reservoir until the coolant level is between the MIN and MAX marks on the reservoir.
3. Reinstall the pressure relief cap.
4. Start and idle the engine until the upper radiator hose is warm (this indicates the thermostat is open and coolant is flowing through the entire system).
5. Shut the engine off and let it cool.
6. Remove the pressure relief cap from the coolant reservoir as previously outlined.
7. Add prediluted coolant to the coolant reservoir until the coolant level is between the MIN and MAX marks on the reservoir.
8. Reinstall the pressure relief cap.
9. Check the coolant level in the reservoir before you drive your vehicle the next few times (with the engine cool).
10. If necessary, add prediluted coolant to the coolant reservoir until the coolant level is between the MIN and MAX marks on the reservoir.

Whenever coolant has been added, the coolant level in the coolant reservoir should be checked the next few times you drive the vehicle. If necessary, add prediluted coolant to bring the coolant level to the proper level.

If you have to add more than 1.0 quart (1.0 liter) of coolant per month, have your dealer check the cooling system. Your cooling system may have a leak. Operating an engine with a low level of coolant can result in engine overheating and possible engine damage.

CHANGING THE WIPER BLADES

To service the windshield wipers, we recommend the following for easier access to the wiper blades.

1. Switch the ignition to accessory mode.
2. Switch the wipers on and switch the ignition off when the wiper blades are in the middle of the windshield.
3. Service the wiper blades. See the Changing Wiper Blades section in the Mustang Owner's Manual for more information.
4. Switch the ignition to accessory mode and switch the wipers off.
5. Switch the ignition off.

CHANGING THE ENGINE AIR FILTER

WARNING



To reduce the risk of vehicle damage or personal burn injuries, do not start your engine with the air cleaner removed and do not remove it while the engine is running.

Maintenance

See the scheduled maintenance information for the appropriate intervals for changing the air filter element.

When changing the air filter element, use only the Motorcraft™ air filter element listed. See the Motorcraft part numbers in the Capacities and Specifications chapter.



E193856

1. Loosen the air filter clamp bolt enough to allow the air filter to slip off the air filter housing easily.
2. Slip the air filter off from the air filter housing.
3. Wipe the air filter housing clean to remove any dirt or debris.
4. Install the new air filter taking care not to damage the air filter element. Align the tab on the closed end of the filter with the notch in the air filter housing.
5. Tighten the air filter clamp bolt.

Vehicle Care

CLEANING THE EXTERIOR

Washing Your Vehicle

Do not drive your vehicle through an automated, commercial car wash due to the vehicle's low ground clearance and tire width. Wash your vehicle by hand, or by using a touchless commercial wash with no mechanical tracks on the floor. Do not use a power washer or high pressure wand. See the Owner's Manual for information on cleaning products and vehicle care.

To maintain proper cooling and aerodynamics at high speeds, your vehicle has heat exchangers integrated with the front fascia designed to maximize performance. Do not use a power washer or high powered spray nozzle as damage to the cooling fins could occur.

Note: For heavy accumulation of debris or dirt, clean with a non-metallic soft bristle car wash brush and warm soapy water as needed.

CLEANING THE ENGINE

Note: Do not allow water or cleaning solutions to contact the exposed air filter element. Cover the air filter assembly and avoid spraying water at it.

CLEANING THE WINDOWS AND WIPER BLADES

Note: Pulling the wiper blade and arm away from the windshield when it is in the park position could cause damage to the hood.

To clean the windshield and wiper blades:

1. Switch the ignition on.
2. Switch the wipers on. When the wiper blades reach the middle of the windshield, switch the ignition off.
3. Pull the wiper blade and arm away from the glass.
4. Clean the wiper blades and windshield with washer fluid or water applied with a soft sponge or cloth.
5. Lower the wiper blade and arm back to its normal position.

Wheels and Tires

WHEELS

Your vehicle has unique wheels matched to the tires. These wheels are more susceptible to damage due to their diameter, width and low profile tires.

To avoid damage to your wheels:

- Maintain proper tire pressure (see Tires in this supplement).
- When installing wheels, always torque lug nuts to specification with a torque wrench.
- Inspect your wheels for damage on a regular basis. If a wheel is damaged, replace it immediately.
- In the event that you encounter an abnormally harsh impact, inspect the outer diameter of your wheels, both inside and out, for damage.

Use Motorcraft™ Wheel and Tire Cleaner to maintain your wheels. See your Owner's Manual for information on other cleaning products and vehicle care.

Wheel Lug Nut Torque Specifications

WARNING



When you install a wheel, always remove any corrosion, dirt or foreign materials present on the mounting surfaces of the wheel or the surface of the wheel hub, brake drum or brake disc that contacts the wheel. Make sure to secure any fasteners that attach the rotor to the hub so they do not interfere with the mounting surfaces of the wheel. Installing wheels without correct metal-to-metal contact at the wheel mounting surfaces can cause the wheel nuts to loosen and the wheel to come off while your vehicle is in motion, resulting in loss of vehicle control, personal injury or death.

Retighten the lug nuts to the specified torque at 500 mi (800 km) after any wheel disturbance (tire rotation, changing a flat tire or wheel removal).

Lug nut size	lb-ft (Nm)*
M14 x 1.5	150 ± 15 (200 ± 20)

*Torque specifications are for nut and bolt threads free of dirt and rust. Use only Ford recommended replacement fasteners.

Carbon Fiber Wheels

The GT350R comes standard with carbon fiber wheels. These wheels offer significant weight savings, while maintaining the structural integrity of aluminum or steel wheels. These wheels have been specifically designed for the R package, and are not recommended for use on other vehicles or Mustang variants. Due care should be taken when mounting and balancing new tires to avoid damage. Ford Performance recommends only using your Ford authorized dealer for service.

The front carbon fiber wheels have a thermal barrier coating on the back of the spokes and on the inner rim barrel. The coating works best when clean. Maintain these areas with Motorcraft Tire and Wheel Cleaner and warm soapy water.

Wheels and Tires

TIRES

WARNING



Only replace the wheels and tires with the tire combinations that Ford has tested and approved for your particular vehicle. Variations in factors such as manufacturing tolerances mean that use of any other wheel and tire combinations, even with identical size ratings, may result in insufficient running clearances, tire rubbing, and eventually puncture. Loss of tire pressure could lead to loss of vehicle control, serious injury or death.

Your vehicle is equipped with low profile, high performance tires that are designed to optimize the driving dynamics you expect in a Ford Performance vehicle. These tires are not optimized for off-road or winter (snow or cold weather) performance, and their ride, noise and wear characteristics are different than non-performance tires. Also, because of their lower profile, the tires are more susceptible to damage due to potholes and rough roads.

Tires	Wheels
GT350 295/35R19 front, 305/35R19 rear	19 in. x 10.5 in. front, 19 in. x 11 in. rear
GT350R 305/30R19 front, 315/30R19 rear	19 in. x 11 in. front, 19 in. x 11.5 in. rear

To make sure that your tires perform as intended, it is important that you maintain your tires properly:

- Your original equipment tires are optimized for performance in both wet and dry conditions. We do not recommend using the original equipment tires when temperatures drop to about 45°F (7°C) or below (depending on tire wear and environmental conditions) or in snow and ice conditions.
- The tires were designed for track use and may exhibit significantly reduced tread life and increased tire noise compared to the standard equipment tires under normal driving conditions. Increasing the front camber settings beyond the factory settings may further accelerate tread wear and induce tire noise.

- For tire pressures, see the placard located on the B-pillar inside the driver door.
- Always maintain your tire pressures according to the tire information placard on the driver door jamb, using an accurate gauge.
- Tire pressures are specified cold and should be checked after the vehicle has been parked for at least three hours. Do not reduce pressure of warm tires.
- Check your tire pressure often to maintain it properly. Tire pressure can diminish over time and fluctuate with temperature.
- Do not overload your vehicle. Maximum vehicle and axle weights are listed on the tire information placard.

Wheels and Tires

- Extra caution should be taken when operating the vehicle near its maximum load, including assuring proper tire pressure and reducing speeds.
- Extra caution should be taken when operating on rough roads to avoid impacts that could cause tire damage.
- In the event that you encounter an abnormally harsh impact, inspect your tires for damage.
- Inspect your tires for damage on a regular basis. If a tire is damaged, replace it immediately.
- Proper suspension alignment is critical for maximum performance and optimal tire wear. If you notice uneven tire wear, have your alignment checked.
- Rotate tires as recommended in the tire rotation information.
- When replacing tires, the only way to maintain original performance is to use the original equipment tire. If a different tire is used, it should be the same size, speed rating and load rating and be replaced as a set of four. Never mix tire brands.
- Use winter tires with the same load index as the summer tires originally equipped with your vehicle.
- Do not operate your vehicle above posted speed limits while using winter tires. Never perform high speed driving with winter tires.
- Do not exceed the speed rating of your tire.

Please call the Ford Performance Info Center at 1-800-367-3788 for specific winter tire recommendations.

Note: *Do not use tire chains on your vehicle. The use of any type of tire chain on these tires may damage your vehicle.*

USING WINTER TIRES

The original equipment tires on your Ford Performance vehicle are designed for maximum performance in dry and wet summer conditions. They are not designed for winter use on ice or snow and cannot be used with tire chains. If you will be operating your vehicle in these conditions, winter or all-season tires must be used.

Capacities and Specifications

MOTORCRAFT PARTS

Component	5.2L engine
Air filter element	FA-1922
Fuel filter	FG-1083
Battery	BXT-99RT4-A
Oil filter	FL-2069-ST
Spark plugs	SP-519 / CYFS-12Y

Note: The use of any oil filter other than the dealer supplied oil filter may cause engine damage.

Note: Use only a Motorcraft FL-2069-ST oil filter for maximum performance, reliability and durability. This filter was specifically engineered for this vehicle.

TECHNICAL SPECIFICATIONS

Item	Capacity	Ford part name or equivalent	Ford part number / Ford specification
Brake fluid ¹	Between MAX and MIN on reservoir	Motorcraft DOT 4 LV High Performance Motor Vehicle Brake Fluid	PM-20 / WSS-M6C65-A2
Rear axle fluid (with external axle lube cooler)	4.1 pints (1.9L)	Motorcraft SAE 75W85 Premium Synthetic Hypoid Gear Lubricant	XY-75W85QL WSS-M2C942-A
Rear axle friction modifier (with external axle lube cooler)	4.25 fl oz (125ml)	Motorcraft Additive Friction Modifier	XL-3 EST-M2C118-A
Engine oil ²	10.0 quarts (9.5L) (with filter change)	Motorcraft SAE 5W-50 Full Synthetic Motor Oil	XO-5W50-QGT WSS-M2C931-B
Engine coolant ³	15.2 quarts (14.4L)	Motorcraft Orange Antifreeze/Coolant Prediluted	VC-3DIL-B

Capacities and Specifications

Item	Capacity	Ford part name or equivalent	Ford part number / Ford specification
			WSS-M97B44-D2
Transmission fluid	2.5 quarts (2.4L)	Motorcraft Mercon LV Automatic Transmission Fluid	XT-10-QLVC

¹Use only Motorcraft DOT 4 LV High Performance Brake Fluid or equivalent meeting WSS-M6C65-A2 and ISO 4925 Class 6. Use of any fluid other than the recommended fluid may cause brake system damage.

²Your engine has been designed to use engine oil that meets Ford specification or an equivalent engine oil of the recommended viscosity grade that displays the API Certification Mark for gasoline engines. Do not use supplemental engine oil additives, cleaners or other engine treatments. They are unnecessary and could lead to engine damage that is not covered by Ford warranty.

³Add the coolant type originally equipped in your vehicle.

Warranty Terms and Conditions

BASE WARRANTY

The GT350 carries the same warranty as other Ford Mustang models. This information is covered in its entirety in the warranty information.

Warranty service for the GT350 or any Ford Performance vehicle can be obtained at any Ford dealer nationwide.

We do not recommend modifying or racing (for competition or time) Ford Performance vehicles, as they are designed and built to be driven as delivered from the factory. The warranty information discusses vehicle usage and the installation of aftermarket parts and their effect on warranty coverage.

Additionally, perform multi-point inspection and the maintenance outlined in the 150000 mile (240000 kilometer) normal maintenance schedule of the scheduled maintenance before and after track use. See the vehicle service manual for removal and installation procedures. Replace with Genuine Ford and Motorcraft® service parts as needed.

These modifications may not necessarily protect your engine from damage in competition conditions. Subjecting your vehicle to competition conditions even with these proposed modifications may render repairs non-reimbursable under the warranty.

Scheduled Maintenance

GENERAL MAINTENANCE INFORMATION

Why Maintain Your Vehicle?

Carefully following the maintenance schedule helps protect against major repair expenses resulting from neglect or inadequate maintenance and may help to increase the value of your vehicle when you sell or trade it. Keep all receipts for completed maintenance with your vehicle.

We have established regular maintenance intervals for your vehicle based upon rigorous testing. It is important that you have your vehicle serviced at the proper times. These intervals serve two purposes; one is to maintain the reliability of your vehicle and the second is to keep your cost of owning your vehicle down.

It is your responsibility to have all scheduled maintenance performed and to make sure that the materials used meet the specifications identified in this owner's manual. See **Capacities and Specifications** (page 44).

Failure to perform scheduled maintenance invalidates warranty coverage on parts affected by the lack of maintenance.

Why Maintain Your Vehicle at Your Dealership?

Factory-Trained Technicians

Service technicians participate in extensive factory-sponsored certification training to help them become experts on the operation of your vehicle. Ask your dealership about the training and certification their technicians have received.

Genuine Ford and Motorcraft® Replacement Parts

Dealerships stock Ford, Motorcraft and Ford-authorized branded re-manufactured replacement parts. These parts meet or exceed our specifications. Parts installed at your dealership carry a nationwide 24-month or unlimited mile (kilometer) parts and labor limited warranty.

If you do not use Ford authorized parts they may not meet our specifications and depending on the part, it could affect emissions compliance.

Convenience

Many dealerships have extended evening and Saturday hours to make your service visit more convenient and they offer one stop shopping. They can perform any services that are required on your vehicle, from general maintenance to collision repairs.

Note: *Not all dealers have extended hours or body shops. Please contact your dealer for details.*

Protecting Your Investment

Maintenance is an investment that pays dividends in the form of improved reliability, durability and resale value. To maintain the proper performance of your vehicle and its emission control systems, make sure you have scheduled maintenance performed at the designated intervals.

Your vehicle is equipped with an intelligent oil-life monitor that determines oil life based on engine operating conditions.

Scheduled Maintenance

- Under normal operating conditions, a message appears in the information display to indicate the regular oil change interval.
- Under severe operating conditions, the oil change intervals reduce, and the message interval adjusts accordingly.

You can drive high performance vehicles in such a way that may lead to higher oil consumption (this includes extended time at high engine speeds, high loads, engine braking, hard cornering maneuvers, and track use). Under these conditions, oil consumption of approximately 1 quart per 500 miles (1 liter per 800 km) is possible. As a result, you need to check the engine oil level at every refueling and adjust to maintain proper levels to avoid engine damage.

Note: *Oil level should not exceed the maximum mark on the indicator. See **Engine Oil Check** (page 36).*

When the oil change message appears in the information display, it is time for an oil change. Make sure you perform the oil change within two weeks or 500 mi (800 km) of the message appearing. Make sure you reset the Intelligent Oil-Life Monitor after each oil change. See (page 15).

If your information display resets prematurely or becomes inoperative, you should perform the oil change interval at six months or 5,000 mi (8,000 km) from your last oil change. Never exceed one year or 10,000 mi (16,000 km) between oil change intervals.

Your vehicle is very sophisticated and built with multiple, complex, performance systems. Every manufacturer develops these systems using different specifications and performance features. That is why it is important to rely upon your dealership to properly diagnose and repair your vehicle.

Ford Motor Company has recommended maintenance intervals for various parts and component systems based upon engineering testing. Ford Motor Company relies upon this testing to determine the most appropriate mileage for replacement of oils and fluids to protect your vehicle at the lowest overall cost to you and recommends against maintenance schedules that deviate from the scheduled maintenance information.

We strongly recommend the use of only genuine Ford, Motorcraft or Ford-authorized re-manufactured replacement parts engineered for your vehicle.

Additives and Chemicals

This owner's manual and the Ford Workshop Manual list the recommended additives and chemicals for your vehicle. We do not recommend using chemicals or additives not approved by us as part of your vehicle's normal maintenance. Please consult your warranty information.

Oils, Fluids and Flushing

In many cases, fluid discoloration is a normal operating characteristic and, by itself, does not necessarily indicate a concern or that the fluid needs to be changed. However, a qualified expert, such as the factory-trained technicians at your dealership, should inspect discolored fluids that also show signs of overheating or foreign material contamination immediately.

Scheduled Maintenance

Make sure to change your vehicle's oils and fluids at the specified intervals or in conjunction with a repair. Flushing is a viable way to change fluid for many vehicle sub-systems during scheduled maintenance. It is critical that systems are flushed only with new fluid that is the same as that required to fill and operate the

system or using a Ford-approved flushing chemical.

Owner Checks and Services

Make sure you perform the following basic maintenance checks and inspections every month or at six-month intervals.

Check every month
Engine oil level (normal vehicle use).
For severe use, (high engine speed and engine loads, engine braking and track use) check engine oil level every fuel fill-up.
Function of all interior and exterior lights.
Tires; for wear and proper pressure.
Windshield washer fluid level.

Check every six months
Battery connections. Clean if necessary.
Body and door drain holes for obstructions. Clean if necessary.
Cooling system fluid level and coolant strength.
Door weatherstrips for wear. Lubricate if necessary.
Hinges, latches and outside locks for proper operation. Lubricate if necessary.
Parking brake for proper operation.
Safety belts and seat latches for wear and function.
Safety warning lamps (brake, ABS, airbag and safety belt) for operation.
Washer spray and wiper operation. Clean or replace blades as necessary.

Scheduled Maintenance

Multi-Point Inspection

In order to keep your vehicle running right, it is important to have the systems on your vehicle checked regularly. This can help identify potential issues and prevent major

problems. We recommend having the following multi-point inspection performed at every scheduled maintenance interval to help make sure your vehicle keeps running great.

Multi-Point inspection	
Accessory drive belt(s)	Hazard warning system operation
Battery performance	Horn operation
Engine air filter	Radiator, cooler, heater and air conditioning hoses
Exhaust system	Suspension components for leaks or damage
Exterior lamps operation	Steering and linkage
Fluid levels*; fill if necessary	Tires; for wear and proper pressure**
For oil and fluid leaks	Windshield for cracks, chips or pits
Half-shaft dust boots	Washer spray and wiper operation

* Brake, coolant recovery reservoir and window washer

**If your vehicle is equipped with a temporary mobility kit, check the tire sealant expiration Use By date on the canister. Replace as needed.

Be sure to ask your dealership service advisor or technician about the multi-point vehicle inspection. It is a comprehensive way to perform a thorough inspection of your vehicle. Your checklist gives you immediate feedback on the overall condition of your vehicle.

NORMAL SCHEDULED MAINTENANCE

Intelligent Oil-Life Monitor®

Your vehicle is equipped with an Intelligent Oil-Life Monitor that determines when you should change the engine oil based on how your vehicle is used. By using several important factors in its calculations, the monitor helps reduce the cost of owning your vehicle and reduces environmental waste at the same time.

Scheduled Maintenance

This means you do not have to remember to change the oil on a mileage-based schedule. Your vehicle lets you know when an oil change is due by displaying a message in the information display.

The following table provides examples of vehicle use and its impact on oil change intervals. It is a guideline only. Actual oil change intervals depend on several factors and generally decrease with severity of use.

When to expect the OIL CHANGE REQUIRED message	
Interval	Vehicle use and example
8,000–12,000 km (5,000–7,500 mi)	Normal
	Normal commuting with highway driving Normal to moderate load Flat to moderately hilly roads No extended idling
4,800–8,000 km (3,000–5,000 mi)	Severe or Extreme
	Moderate to heavy load Mountainous conditions Extended idling Extended hot or cold operation Maximum load or track use Extreme hot or cold operation High engine speed

Normal Maintenance Intervals

At every oil change interval as indicated by the information display*
Change engine oil and filter.**
Rotate tires, inspect tire wear and measure tread depth.
Perform a multi-point inspection (recommended).
Inspect the brake pads, shoes, rotors, brake linings, hoses and parking brake.
Inspect the engine cooling system strength and hoses.
Inspect the exhaust system and heat shields.
Inspect rear axle and U-joints. Lubricate if equipped with grease fittings.

Scheduled Maintenance

At every oil change interval as indicated by the information display*
Inspect the half-shaft boots.
Inspect the steering linkage, ball joints, suspension, tie-rod ends, driveshaft and U-joints. Lubricate any areas with grease fittings.
Inspect the wheels and related components for abnormal noise, wear, looseness or drag.

* Do not exceed one year or 10,000 mi (16,000 km) between service intervals.

** Reset the Intelligent Oil-Life Monitor after engine oil and filter changes.

Other maintenance items¹	
Every 20,000 mi (32,000 km)	Replace cabin air filter.
Every 30,000 mi (48,000 km)	Replace engine air filter.
	Replace fuel filter.
At 100,000 mi (160,000 km)	Change engine coolant. ²
Every 100,000 mi (160,000 km)	Replace spark plugs.
	Inspect accessory drive belt(s). ³
Every 150,000 mi (240,000 km)	Change manual transmission fluid.
	Change differential fluid.
	Replace accessory drive belt(s).

¹ Perform these maintenance items within 3,000 mi (4,800 km) of the last engine oil and filter change. Do not exceed the designated distance for the interval.

² Initial replacement at six years or 100,000 mi (160,000 km), then every three years or 50,000 mi (80,000 km).

³ After initial inspection, inspect every other oil change until replaced.

Scheduled Maintenance

SPECIAL OPERATING CONDITIONS SCHEDULED MAINTENANCE

If you operate your vehicle **primarily** in any of the following conditions, you need to perform extra maintenance, as indicated. If you operate your vehicle **occasionally** under any of these conditions, it is not necessary to perform the extra maintenance. For specific recommendations, see your dealership service advisor or technician.

Perform the services shown in the following tables when specified or within 3,000 mi (4,800 km) of a message appearing in the information display prompting you to change your oil.

- **Example 1:** The message comes on at 28,751 mi (46,270 km). Perform the 30,000 mi (48,000 km) automatic transmission fluid replacement.
- **Example 2:** The message has **not** come on, but the odometer reads 30,000 mi (48,000 km) (for example, the Intelligent Oil-Life Monitor was reset at 25,000 mi (40,000 km)). Perform the engine air filter replacement.

Extensive idling or low-speed driving for long distances

As required	Change engine oil and filter as indicated by the information display and perform services listed in the Normal Scheduled Maintenance chart.
Inspect frequently, service as required	Replace cabin air filter.
Every 15,000 mi (24,000 km)	Inspect engine air filter. Replace as required.
Every 60,000 mi (96,000 km)	Replace spark plugs.

Operating in dusty or sandy conditions (such as unpaved or dusty roads)

Inspect frequently, service as required	Replace cabin air filter.
Every 15,000 mi (24,000 km)	Inspect engine air filter. Replace as required.
Every 5,000 mi (8,000 km)	Inspect the wheels and related components for abnormal noise, wear, looseness or drag.
	Rotate tires, inspect tires for wear and measure tread depth.

Scheduled Maintenance

Operating in dusty or sandy conditions (such as unpaved or dusty roads)	
Every 5,000 mi (8,000 km) or six months	Change engine oil and filter.*
Every 50,000 mi (80,000 km)	Change manual transmission fluid.

*Reset your Intelligent Oil-Life Monitor after each engine oil and filter change.

Exceptions

There are several exceptions to the Normal Schedule:

Axle Maintenance

Change the axle fluid anytime an axle is submerged in water.

Timing Chain

If you use your vehicle extensively at a race track or at high rpm, it is possible to exceed the service life of the engine timing chain. A wrench indicator light will illuminate when it is time for you to replace your chain. See an authorized dealer.

California Fuel Filter Replacement

If you register your vehicle in California, the California Air Resources Board has determined that the failure to perform this maintenance item does not nullify the emission warranty or limit recall liability before the completion of your vehicle's useful life. Ford Motor Company, however, urges you to have all recommended maintenance services performed at the specified intervals and to record all vehicle service.

Hot Climate Oil Change Intervals

Vehicles operating in the Middle East or locations with similar climates using an American Petroleum Institute (API) Certified for Gasoline Engines (Certification mark) oil of SM or SN quality, the normal oil change interval is 3,000 mi (4,800 km).

If the available API SM or SN oils are not available, then the oil change interval is 1,800 mi (2,900 km).

Engine Air Filter and Cabin Air Filter Replacement

The life of the engine air filter and cabin air filter is dependent on exposure to dusty and dirty conditions. Vehicles operated in these conditions require frequent inspection and replacement of the engine air filter and cabin air filter.

Scheduled Maintenance

SCHEDULED MAINTENANCE RECORD

<input type="radio"/> Repair Order #:	<p>Dealer stamp</p>
<input type="radio"/> Distance:	
<input type="radio"/> Engine hours (optional):	
<input type="radio"/> Multi-point inspection (recommended): <input type="checkbox"/>	
<input type="radio"/> Signature:	

<input type="radio"/> Repair Order #:	<p>Dealer stamp</p>
<input type="radio"/> Distance:	
<input type="radio"/> Engine hours (optional):	
<input type="radio"/> Multi-point inspection (recommended): <input type="checkbox"/>	
<input type="radio"/> Signature:	

Scheduled Maintenance

<input type="radio"/> Repair Order #:	Dealer stamp
<input type="radio"/> Distance:	
<input type="radio"/> Engine hours (optional):	
<input type="radio"/> Multi-point inspection (recommended): <input type="checkbox"/>	
<input type="radio"/> Signature:	

<input type="radio"/> Repair Order #:	Dealer stamp
<input type="radio"/> Distance:	
<input type="radio"/> Engine hours (optional):	
<input type="radio"/> Multi-point inspection (recommended): <input type="checkbox"/>	
<input type="radio"/> Signature:	

Scheduled Maintenance

<input type="radio"/> Repair Order #:	<p>Dealer stamp</p>
<input type="radio"/> Distance:	
<input type="radio"/> Engine hours (optional):	
<input type="radio"/> Multi-point inspection (recommended): <input type="checkbox"/>	
<input type="radio"/> Signature:	

<input type="radio"/> Repair Order #:	<p>Dealer stamp</p>
<input type="radio"/> Distance:	
<input type="radio"/> Engine hours (optional):	
<input type="radio"/> Multi-point inspection (recommended): <input type="checkbox"/>	
<input type="radio"/> Signature:	

Scheduled Maintenance

<input type="radio"/> Repair Order #:	Dealer stamp
<input type="radio"/> Distance:	
<input type="radio"/> Engine hours (optional):	
<input type="radio"/> Multi-point inspection (recommended): <input type="checkbox"/>	
<input type="radio"/> Signature:	

<input type="radio"/> Repair Order #:	Dealer stamp
<input type="radio"/> Distance:	
<input type="radio"/> Engine hours (optional):	
<input type="radio"/> Multi-point inspection (recommended): <input type="checkbox"/>	
<input type="radio"/> Signature:	

Scheduled Maintenance

<input type="radio"/> Repair Order #:	<p>Dealer stamp</p>
<input type="radio"/> Distance:	
<input type="radio"/> Engine hours (optional):	
<input type="radio"/> Multi-point inspection (recommended): <input type="checkbox"/>	
<input type="radio"/> Signature:	

<input type="radio"/> Repair Order #:	<p>Dealer stamp</p>
<input type="radio"/> Distance:	
<input type="radio"/> Engine hours (optional):	
<input type="radio"/> Multi-point inspection (recommended): <input type="checkbox"/>	
<input type="radio"/> Signature:	

Scheduled Maintenance

<input type="radio"/> Repair Order #:	Dealer stamp
<input type="radio"/> Distance:	
<input type="radio"/> Engine hours (optional):	
<input type="radio"/> Multi-point inspection (recommended): <input type="checkbox"/>	
<input type="radio"/> Signature:	

<input type="radio"/> Repair Order #:	Dealer stamp
<input type="radio"/> Distance:	
<input type="radio"/> Engine hours (optional):	
<input type="radio"/> Multi-point inspection (recommended): <input type="checkbox"/>	
<input type="radio"/> Signature:	

Scheduled Maintenance

<input type="radio"/> Repair Order #:	<p>Dealer stamp</p>
<input type="radio"/> Distance:	
<input type="radio"/> Engine hours (optional):	
<input type="radio"/> Multi-point inspection (recommended): <input type="checkbox"/>	
<input type="radio"/> Signature:	

<input type="radio"/> Repair Order #:	<p>Dealer stamp</p>
<input type="radio"/> Distance:	
<input type="radio"/> Engine hours (optional):	
<input type="radio"/> Multi-point inspection (recommended): <input type="checkbox"/>	
<input type="radio"/> Signature:	

Scheduled Maintenance

<input type="radio"/> Repair Order #:	<p>Dealer stamp</p>
<input type="radio"/> Distance:	
<input type="radio"/> Engine hours (optional):	
<input type="radio"/> Multi-point inspection (recommended): <input type="checkbox"/>	
<input type="radio"/> Signature:	

<input type="radio"/> Repair Order #:	<p>Dealer stamp</p>
<input type="radio"/> Distance:	
<input type="radio"/> Engine hours (optional):	
<input type="radio"/> Multi-point inspection (recommended): <input type="checkbox"/>	
<input type="radio"/> Signature:	

Scheduled Maintenance

<input type="radio"/> Repair Order #:	<p>Dealer stamp</p>
<input type="radio"/> Distance:	
<input type="radio"/> Engine hours (optional):	
<input type="radio"/> Multi-point inspection (recommended): <input type="checkbox"/>	
<input type="radio"/> Signature:	

<input type="radio"/> Repair Order #:	<p>Dealer stamp</p>
<input type="radio"/> Distance:	
<input type="radio"/> Engine hours (optional):	
<input type="radio"/> Multi-point inspection (recommended): <input type="checkbox"/>	
<input type="radio"/> Signature:	

Scheduled Maintenance

<input type="radio"/> Repair Order #:	<p>Dealer stamp</p>
<input type="radio"/> Distance:	
<input type="radio"/> Engine hours (optional):	
<input type="radio"/> Multi-point inspection (recommended): <input type="checkbox"/>	
<input type="radio"/> Signature:	

<input type="radio"/> Repair Order #:	<p>Dealer stamp</p>
<input type="radio"/> Distance:	
<input type="radio"/> Engine hours (optional):	
<input type="radio"/> Multi-point inspection (recommended): <input type="checkbox"/>	
<input type="radio"/> Signature:	

Index

A

About This Supplement.....	3
Ford Performance.....	4
SVT History.....	4
Team RS History.....	4
ABS	
See: Brakes.....	26
Air Filter	
See: Changing the Engine Air Filter.....	38
At a Glance.....	6
Engine Specifications.....	8
Suspension Specifications.....	8
Vehicle Specifications.....	7
Audio Control.....	12

B

Base Warranty.....	46
Brakes.....	26
General Information.....	26
Breaking-In.....	33
Ground Clearance.....	33

C

Capacities and Specifications.....	44
Technical Specifications.....	44
Car Wash	
See: Cleaning the Exterior.....	40
Changing the Engine Air Filter.....	38
Changing the Engine Oil and Oil Filter.....	36
Changing the Wiper Blades.....	38
Child Safety.....	10
Cleaning the Engine.....	40
Cleaning the Exterior.....	40
Washing Your Vehicle.....	40
Cleaning the Windows and Wiper Blades.....	40
Coolant Check	
See: Engine Coolant Check.....	36

D

Daytime Running Lamps.....	13
Driving Hints.....	33
Driving Through Water.....	33

DRL

See: Daytime Running Lamps.....	13
---------------------------------	----

E

Engine Coolant Check.....	36
Adding Engine Coolant.....	37
Engine Oil Check.....	36
Engine Oil Recommendation.....	36

F

Fuel and Refueling.....	23
Fuel Quality.....	23
Choosing the Right Fuel.....	23
Fuses.....	34
Fuse Specification Chart.....	34

G

Gauges.....	14
Gearbox	
See: Transmission.....	24
General Maintenance Information.....	47
Multi-Point Inspection.....	50
Owner Checks and Services.....	49
Protecting Your Investment.....	47
Why Maintain Your Vehicle?.....	47
Why Maintain Your Vehicle at Your Dealership?.....	47

I

Information Displays.....	15
General Information.....	15
Installing Child Restraints.....	10
Rear Seat Delete.....	10
Instrument Cluster.....	14
Introduction.....	3

L

Lighting.....	13
---------------	----

M

Maintenance.....	35
------------------	----

Index

Manual Transmission.....	24
Using the Clutch.....	24
Message Center	
See: Information Displays.....	15
Motorcraft Parts.....	44

N

Normal Scheduled Maintenance.....	50
Intelligent Oil-Life Monitor®.....	50
Normal Maintenance Intervals.....	51

O

Oil Check	
See: Engine Oil Check.....	36

R

Refueling.....	23
Octane Recommendations.....	23
Running-In	
See: Breaking-In.....	33

S

Scheduled Maintenance Record.....	55
Scheduled Maintenance.....	47
Special Operating Conditions Scheduled	
Maintenance.....	53
Exceptions.....	54
Stability Control.....	27
Steering Wheel.....	12

T

Technical Specifications	
See: Capacities and Specifications.....	44
Tires.....	42
Tires	
See: Wheels and Tires.....	41
Towing a Trailer.....	29
Towing.....	29
Transmission.....	24
Transporting the Vehicle.....	29
Transportation Instructions.....	30

U

Under Hood Overview.....	35
Using Stability Control.....	27
Integrated Driver Control	27
Using Winter Tires.....	43

V

Vehicle Care.....	40
Voice Control.....	12
Drive Mode Control.....	12

W

Warranty Terms and Conditions.....	46
Washers	
See: Cleaning the Exterior.....	40
Wheels and Tires.....	41
Wheels.....	41
Wheel Lug Nut Torque Specifications.....	41
Winter Tires	
See: Using Winter Tires.....	43
Wrecker Towing	
See: Transporting the Vehicle.....	29

