

Jeep®

# User Guide

2012

# Wrangler

Includes Wrangler Unlimited



**If you are the first registered retail owner of your vehicle, you may obtain a complimentary printed copy of the Owner's Manual, Navigation/Media Center Manuals or Warranty Booklet by calling 1-877-426-5337 (U.S.) or 1-800-387-1143 (Canada) or by contacting your dealer.**

The driver's primary responsibility is the safe operation of the vehicle. Driving while distracted can result in loss of vehicle control, resulting in a collision and personal injury. Chrysler Group LLC strongly recommends that the driver use extreme caution when using any device or feature that may take their attention off the road. Use of any electrical devices such as cell phones, computers, portable radios, vehicle navigation or other devices by the driver while the

vehicle is moving is dangerous and could lead to a serious collision. Texting while driving is also dangerous and should never be done while the vehicle is moving. If you find yourself unable to devote your full attention to vehicle operation, pull off the road to a safe location and stop your vehicle. Some States or Provinces prohibit the use of cellular telephones or texting while driving. It is always the driver's responsibility to comply with all local laws.

## **Important:**

This User Guide is intended to familiarize you with the important features of your vehicle. The DVD enclosed contains your Owner's Manual, Navigation/Media Center Manuals, Warranty Booklets, Tire Warranty and 24-Hour Towing Assistance (new vehicles purchased in the U.S.) or Roadside Assistance (new vehicles purchased in Canada) in electronic format. We hope you find it useful. Replacement DVD kits may be purchased by visiting [www.techauthority.com](http://www.techauthority.com). Jeep® is a registered trademark of Chrysler Group LLC. Copyright 2011 Chrysler Group LLC.

# TABLE OF CONTENTS

## **INTRODUCTION/WELCOME**

Welcome From Chrysler Group LLC . . . 2

## **CONTROLS AT A GLANCE**

Driver Cockpit . . . . . 4  
Instrument Cluster . . . . . 6

## **GETTING STARTED**

Key Fob . . . . . 8  
Remote Start . . . . . 8  
Theft Alarm . . . . . 9  
Seat Belt . . . . . 9  
Supplemental Restraint System  
(SRS) — Air Bags . . . . . 10  
Child Restraints . . . . . 11  
Front Seats . . . . . 13  
Rear Seats . . . . . 15  
Tilt Steering Column . . . . . 16  
Heated Seats . . . . . 16

## **OPERATING YOUR VEHICLE**

Engine Break-In Recommendations . . . 18  
Turn Signal/Lights Lever . . . . . 18  
Wiper/Washer Lever . . . . . 19  
Speed Control . . . . . 20  
Manual Climate Controls . . . . . 21  
Automatic Temperature Controls  
(ATC) . . . . . 22  
Soft Top And Sunrider® . . . . . 23  
Hard Top And Freedom Top® . . . . . 27  
Wind Buffeting . . . . . 29

## **ELECTRONICS**

Your Vehicle's Sound System . . . . . 30  
Media Center 130 (Sales Code RES) . . . 32  
Media Center 130 With Satellite Radio  
(Sales Code RES + RSC) . . . . . 34  
Media Center 230  
(Sales Code REQ) . . . . . 36  
Media Center 430/430N (Sales  
Code RBZ/RHB) . . . . . 39  
Media Center 730N  
(Sales Code RHR) . . . . . 48  
Sirius Travel Link (Media Center  
730N (RHR) & Media Center 430N  
(RHB) Only) . . . . . 58  
Steering Wheel Audio Controls . . . . . 59  
iPod®/USB/MP3 Control . . . . . 60  
Uconnect™ Phone . . . . . 60  
Uconnect™ Voice Command . . . . . 63  
Bluetooth® Streaming Audio . . . . . 66  
Electronic Vehicle Information  
Center (EVIC) . . . . . 66  
Programmable Features . . . . . 67  
Power Inverter . . . . . 68

Power Outlets . . . . . 68

## **OFF-ROAD CAPABILITIES**

Command-Trac®/Rock-Trac® . . . . . 70  
Axle Lock (Tru-Lok®) Rubicon Only . . 70  
Electronic Sway Bar Disconnect -  
Rubicon Only . . . . . 71

## **UTILITY**

Trailer Towing Weights (Maximum  
Trailer Weight Ratings) . . . . . 72  
Recreational Towing (Behind  
Motorhome, Etc.) . . . . . 74

## **WHAT TO DO IN EMERGENCIES**

24-Hour Towing Assistance . . . . . 77  
Instrument Cluster Warning Lights . . 77  
If Your Engine Overheats . . . . . 81  
Jacking And Tire Changing . . . . . 82  
Jump-Starting . . . . . 86  
Emergency Tow Hooks . . . . . 88  
Shift Lever Override . . . . . 89  
Towing A Disabled Vehicle . . . . . 89  
Freeing A Stuck Vehicle . . . . . 89  
Event Data Recorder (EDR) . . . . . 91

## **MAINTAINING YOUR VEHICLE**

Opening The Hood . . . . . 92  
Engine Compartment . . . . . 93  
Fluids And Capacities . . . . . 94  
Maintenance Chart . . . . . 96  
Fuses . . . . . 99  
Tire Pressures . . . . . 103  
Wheel And Wheel Trim Care . . . . . 104  
Exterior Bulbs . . . . . 104

## **CONSUMER ASSISTANCE**

Chrysler Group LLC Customer  
Center . . . . . 105  
Chrysler Canada Inc. Customer  
Center . . . . . 105  
Assistance For The Hearing  
Impaired . . . . . 105  
Publications Ordering . . . . . 105  
Reporting Safety Defects In The  
50 United States And  
Washington, D.C. . . . . 106

## **MOPAR ACCESSORIES**

Authentic Accessories By MOPAR® . 107

## **INDEX**

. . . . . 109

## **FAQ (How To?)**

Frequently Asked Questions . . . . . 112

# INTRODUCTION/WELCOME

## **WELCOME FROM CHRYSLER GROUP LLC**

Congratulations on selecting your new Chrysler Group LLC vehicle. Be assured that it represents precision workmanship, distinctive styling, and high quality - all essentials that are traditional to our vehicles.

Your new Chrysler Group LLC vehicle has characteristics to enhance the driver's control under some driving conditions. These are to assist the driver and are never a substitute for attentive driving. They can never take the driver's place. Always drive carefully.

Your new vehicle has many features for the comfort and convenience of you and your passengers. Some of these should not be used when driving because they take your eyes from the road or your attention from driving. Never text while driving or take your eyes more than momentarily off the road.

This guide illustrates and describes the operation of features and equipment that are either standard or optional on this vehicle. This guide may also include a description of features and equipment that are no longer available or were not ordered on this vehicle. Please disregard any features and equipment described in this guide that are not available on this vehicle. Chrysler Group LLC reserves the right to make changes in design and specifications and/or make additions to or improvements to its products without imposing any obligation upon itself to install them on products previously manufactured.

This User Guide has been prepared to help you quickly become acquainted with the important features of your vehicle. It contains most things you will need to operate and maintain the vehicle, including emergency information.

The DVD includes a computer application containing detailed owner's information which can be viewed on a personal computer or MAC computer. The multimedia DVD also includes videos which can be played on any standard DVD player (including the Media Center Touch-Screen Radios). Additional DVD operational information is located on the back of the DVD sleeve.

For complete owner information, refer to your Owner's Manual on the DVD in the owner's kit provided at the time of new vehicle purchase. For your convenience, the information contained on the DVD may also be printed and saved for future reference.

Chrysler Group LLC is committed to protecting our environment and natural resources. By converting from paper to electronic delivery for the majority of the user information for your vehicle, together we greatly reduce the demand for tree-based products and lessen the stress on our environment.



This is a specialized utility vehicle designed for both on-road and off-road use. It can go places and perform tasks for which conventional two-wheel drive enclosed vehicles were not intended. It handles and maneuvers differently from many passenger cars both on-road and off-road, so take time to become familiar with your vehicle.

### **Vehicles Sold In Canada**

With respect to any vehicles sold in Canada, the name Chrysler Group LLC shall be deemed to be deleted and the name Chrysler Canada Inc. used in substitution therefore.

# INTRODUCTION/WELCOME

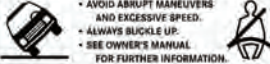
## Rollover Warning

<p><b>▲ WARNING</b> <b>EVEN WITH ADVANCED AIR BAGS</b></p>  <ul style="list-style-type: none"><li>• CHILDREN CAN BE KILLED OR SERIOUSLY INJURED BY THE AIR BAG.</li><li>• THE BACK SEAT IS THE SAFEST PLACE FOR CHILDREN.</li><li>• NEVER PUT A REAR-FACING CHILD SEAT IN THE FRONT.</li><li>• ALWAYS USE SEAT BELTS AND CHILD RESTRAINTS.</li><li>• SEE OWNER'S MANUAL FOR MORE INFORMATION ABOUT AIR BAGS.</li></ul>	<p><b>▲ WARNING</b> <b>HIGHER ROLLOVER RISK</b></p>  <ul style="list-style-type: none"><li>• AVOID ABRUPT MANEUVERS AND EXCESSIVE SPEED.</li><li>• ALWAYS BUCKLE UP.</li><li>• SEE OWNER'S MANUAL FOR FURTHER INFORMATION.</li></ul>
<p><b>▲ MISE EN GARDE</b> <b>MÊME AVEC DES SACS GONFLABLES PERFECTIONNÉS</b></p> <ul style="list-style-type: none"><li>• LES ENFANTS PEUVENT ÊTRE TUÉS OU GRAVEMENT BLESSÉS PAR UN SAC GONFLABLE.</li><li>• LA BANQUETTE ARRIÈRE EST LA PLACE LA PLUS SÛRITAIRE POUR LES ENFANTS.</li><li>• NE JAMAIS PLACER UN SIÈGE POUR ENFANT ORIENTÉ VERS L'ARRIÈRE À L'AVANT DU VÉHICULE.</li><li>• UTILISEZ TOUJOURS LA CEINTURE DE SÛRITÉ ET LE SYSTÈME DE RETENUE POUR ENFANT.</li><li>• CONSULTEZ LE GUIDE DE L'AUTOMOBILISTE POUR OBTENIR PLUS DE RENSEIGNEMENTS SUR LES SACS GONFLABLES.</li></ul>	<p><b>▲ MISE EN GARDE</b> <b>PLUS GRAND RISQUE DE CAPOTAGE</b></p> <ul style="list-style-type: none"><li>• ÉVITER LES MANŒUVRES ABRUPTES ET LA VITESSE EXCESSIVE.</li><li>• PORTER TOUJOURS LES CEINTURES DE SÛRITÉ.</li><li>• CONSULTER LE GUIDE DE L'AUTOMOBILISTE POUR DE PLUS AMPLES RENSEIGNEMENTS.</li></ul>
<p><b>▲ ADVERTENCIA</b> <b>AUN CON SISTEMAS AVANZADOS DE BOLSA DE AIRE</b></p> <ul style="list-style-type: none"><li>• LA BOLSA DE AIRE PUEDE CAUSAR SERIOS DAÑOS O LA MUERTE A LOS NIÑOS.</li><li>• EL ASIENTO DE ATRAS ES EL LUGAR MÁS SEGURO PARA LOS NIÑOS.</li><li>• NUNCA PONGA UN ASIENTO DE NIÑO CON LA CARA HACIA ATRAS, EN EL ASIENTO DELANTERO.</li><li>• SIEMPRE USE LOS CINTURONES DE SEGURIDAD Y SISTEMAS DE SEGURIDAD PARA NIÑOS.</li><li>• PARA MÁS INFORMACIÓN SOBRE BOLSA DE AIRE, CONSULTE EL MANUAL DEL PROPIETARIO.</li></ul>	<p><b>▲ ADVERTENCIA</b> <b>ALTO RIESGO DE VOLCAMIENTO</b></p> <ul style="list-style-type: none"><li>• EVITE MANIOBRAS ABRUPTAS Y VELOCIDAD EXCESIVA.</li><li>• USE SIEMPRE EL CINTURÓN DE SEGURIDAD.</li><li>• PARA MAYOR INFORMACIÓN VER MANUAL DEL PROPIETARIO.</li></ul> <p> ©2011 CHRYSLER GROUP LLC</p>

## WARNING!

- Pedals that cannot move freely can cause loss of vehicle control and increase the risk of serious personal injury.
- Always make sure that objects cannot fall into the driver foot well while the vehicle is moving. Objects can become trapped under the brake pedal and accelerator pedal causing a loss of vehicle control.
- Failure to properly follow floor mat installation or mounting can cause interference with the brake pedal and accelerator pedal operation causing loss of control of the vehicle.
- Refer to your Owner's Manual on the DVD for further details.
- Never use the 'PARK' position as a substitute for the parking brake. Always apply the parking brake fully when parked to guard against vehicle movement and possible injury or damage.

## USE OF AFTERMARKET PRODUCTS (ELECTRONICS)

The use of aftermarket devices including cell phones, MP3 players, GPS systems, or chargers may affect the performance of on-board wireless features including Keyless Enter-N-Go and Remote Start range. If you are experiencing difficulties with any of your wireless features, try disconnecting your aftermarket devices to see if the situation improves. If your symptoms persist, please see an authorized dealer.

CHRYSLER, JEEP, MOPAR, ATF+4, COMMAND-TRAC, FREEDOM TOP, ROCK-TRAC, RUBICON, SAHARA, TRU-LOK, Uconnect and WRANGLER are registered trademarks of Chrysler Group LLC.

**COPYRIGHT ©2011 CHRYSLER GROUP LLC**



# CONTROLS AT A GLANCE

## DRIVER COCKPIT

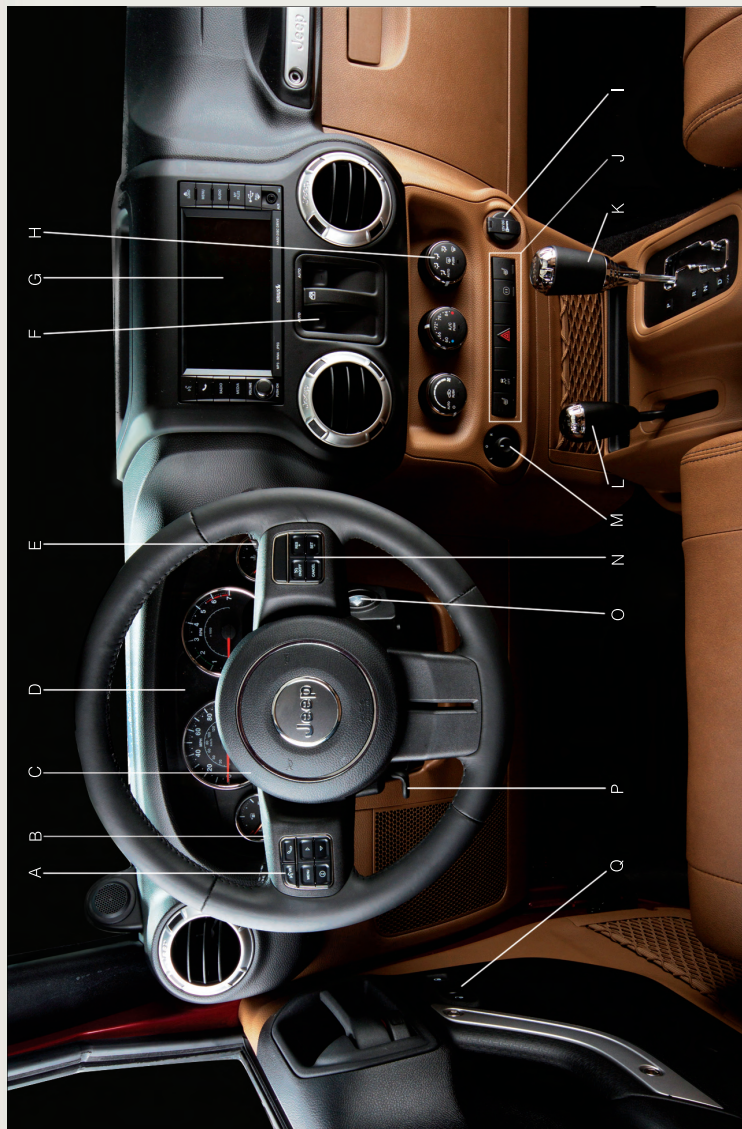

# CONTROLS AT A GLANCE









- A. Electronic Vehicle Information Center (EVIC) Controls pg. 66
- B. Turn Signal/Lights Lever (behind steering wheel) pg. 18
- C. Electronic Vehicle Information Center (EVIC) Display (behind steering wheel) pg. 66
- D. Instrument Cluster pg. 6
- E. Wiper/Washer Lever (behind steering wheel) pg. 19
- F. Power Windows
- G. Audio System (touch-screen-radio shown) pg. 30
- H. Climate Controls pg. 21
- I. Power Outlet/Cigar Lighter pg. 68
- J. SWITCH PANEL
  - Heated Seat Switches pg. 16
    - Electronic Stability Control pg. 77
    - Hill Descent
    - Hazard Switch
- K. Transmission Gear Selector
- L. Transfer Case Gear Selector
- M. Power Mirrors
- N. Speed Control pg. 20
- O. Ignition Switch
- P. Hood Release pg. 92
- Q. Power Door Locks



# CONTROLS AT A GLANCE



## INSTRUMENT CLUSTER

### Warning Lights

-  - Low Fuel Warning Light
-  - Charging System Light\*\*
-  - Oil Pressure Warning Light\*\*
-  - Anti-Lock Brake (ABS) Light\*\*
-  - Air Bag Warning Light\*\*
-  - Electronic Throttle Control (ETC) Light
-  - Tire Pressure Monitoring System (TPMS) Light
-  - Engine Temperature Warning Light
-  - Seat Belt Reminder Light

- BRAKE**  - Brake Warning Light\*\*
-  - Malfunction Indicator Light (MIL)\*\*
-  - Electronic Stability Control (ESC) Activation/Malfunction Indicator Light\*\*

(See page 77 for more information.)



# CONTROLS AT A GLANCE



## Indicators



- Turn Signal Indicators



- High Beam Indicator



- Front Fog Light Indicator



- Front Axle Lock Indicator\*



- Rear Axle Lock Indicator\*



- Vehicle Security Indicator\*



- O/D (Overdrive) Off Indicator

**4WD**

- 4WD Indicator\*

**SWAY  
BAR**

- Sway Bar Indicator\*

**OFF**

- Electronic Stability Control (ESC) Off Indicator

**CRUISE**

- Cruise Indicator

## Odometer Messages

ECO - Fuel Saver Indicator  
door - Door Ajar

gASCAP - Fuel Cap Fault  
gATE\* - Swing Gate Ajar  
noFUSE\* - Fuse Fault

LoW tirE\* - Low Tire Pressure  
HOTOIL\* - Transmission Temperature  
Warning Message  
CHAngE OIL\* - Change Engine Oil  
ESPOFF\* - ESP Deactivated

\* If equipped

\*\* Bulb Check with Key On

# GETTING STARTED

## KEY FOB



### Locking And Unlocking The Doors/Swing Gate

- Press the LOCK button once to lock all the doors and swing gate. Press the UNLOCK button once to unlock the driver's door only and twice within five seconds to unlock all the doors and swing gate.

- All doors can be programmed to unlock on the first press of the UNLOCK button. Refer to Programmable Features in this guide.

### Panic Alarm

- Press the PANIC button once to turn the panic alarm on.
- Wait approximately three seconds and press the button a second time to turn the panic alarm off.

## WARNING!

- Leaving unattended children in a vehicle is dangerous for a number of reasons. A child or others could be severely injured or killed. Children should be warned not to touch the parking brake, brake pedal, or the shift lever. Do not leave the Key Fob inside the vehicle or in the ignition. A child could start the vehicle, operate power windows, other controls, or move the vehicle.
- Do not leave children or animals inside parked vehicles in hot weather. Interior heat build-up may cause them to be severely injured or killed.

## REMOTE START

- Press the REMOTE START button  twice within five seconds. Pressing the REMOTE START button a third time shuts the engine off.
- To drive the vehicle, press the UNLOCK button, insert the key in the ignition and turn to the ON/RUN position.
- With remote start, the engine will only run for 15 minutes (timeout) unless the ignition key is placed in the ON/RUN position.
- The vehicle must be started with the key after two consecutive timeouts.

# GETTING STARTED

## WARNING!

- Do not start or run an engine in a closed garage or confined area. Exhaust gas contains Carbon Monoxide (CO) which is odorless and colorless. Carbon Monoxide is poisonous and can cause you or others to be severely injured or killed when inhaled.
- Keep Key Fob transmitters away from children. Operation of the Remote Start System, windows, door locks or other controls could cause you and others to be severely injured or killed.

## THEFT ALARM

### To Arm

- Press the Key Fob LOCK button or the power door lock switch while the door is open.

### To Disarm

- Press the Key Fob UNLOCK button and turn the ignition to the ON/RUN position.

## SEAT BELT

- Be sure everyone in your vehicle is in a seat and using a seat belt properly.
- Position the lap belt across your thighs, below your abdomen. To remove slack in the lap portion, pull up a bit on the shoulder belt. To loosen the lap belt if it is too tight, tilt the latch plate and pull on the lap belt. A snug belt reduces the risk of sliding under the belt in a collision.
- Position the shoulder belt on your chest so that it is comfortable and not resting on your neck. The retractor will withdraw any slack in the belt.
- A shoulder belt placed behind you will not protect you from injury during a collision. You are more likely to hit your head in a collision if you do not wear your shoulder belt. The lap and shoulder belt are meant to be used together.
- A belt that is too loose will not protect you properly. In a sudden stop you could move too far forward, increasing the possibility of injury. Wear your seat belt snugly.
- A frayed or torn belt could rip apart in a collision and leave you with no protection. Inspect the belt system periodically, checking for cuts, frays, or loose parts. Damaged parts must be replaced immediately. Do not disassemble or modify the system. Seat belt assemblies must be replaced after a collision if they have been damaged (bent retractor, torn webbing, etc.).
- The seat belts for both front seating positions are equipped with pretensioning devices that are designed to remove slack from the seat belt in the event of a collision.

# GETTING STARTED

- A deployed pretensioner or a deployed air bag must be replaced immediately.

## WARNING!

In a collision, you and your passengers can suffer much greater injuries if you are not buckled up properly. You can strike the interior of your vehicle or other passengers, or you can be thrown out of the vehicle. Always be sure you and others in your vehicle are buckled up properly.

## SUPPLEMENTAL RESTRAINT SYSTEM (SRS) — AIR BAGS

- This vehicle has Advanced Front Air Bags for both the driver and right front passenger as a supplement to the seat belt restraint system. The Advanced Front Air Bags will not deploy in every type of collision.
- Advanced Front Air Bags are designed to provide additional protection by supplementing the seat belts in certain frontal collisions depending on the severity and type of collision. Advanced Front Air Bags are not expected to reduce the risk of injury in rear, side, or rollover collisions.
- This vehicle may be equipped with Supplemental Seat-Mounted Side Air Bags to provide enhanced protection to help protect an occupant during a side impact.
- If the Air Bag Warning Light  is not on during starting, stays on, or turns on while driving, have the vehicle serviced by an authorized service center immediately.
- Refer to the Owner's Manual on the DVD for further details regarding the Supplemental Restraint System (SRS).

## WARNING!

- Relying on the air bags alone could lead to more severe injuries in a collision. The air bags work with your seat belt to restrain you properly. In some collisions, the air bags won't deploy at all. Always wear your seat belts even though you have air bags.
- Being too close to the steering wheel or instrument panel during Advanced Front Air Bag deployment could cause serious injury, including death. Air bags need room to inflate. Sit back, comfortably extending your arms to reach the steering wheel or instrument panel.
- Supplemental Seat-Mounted Side Air Bags need room to inflate. Do not lean against the door or window. Sit upright in the center of the seat.

*(Continued)*

# GETTING STARTED

## **WARNING!** *(Continued)*

- Being too close to the Seat-Mounted Side Air Bag during deployment could cause you to be severely injured or killed.
- Do not drive your vehicle after the air bags have deployed. If you are involved in another collision, the air bags will not be in place to protect you.
- After any collision, the vehicle should be taken to an authorized dealer immediately.

## **CHILD RESTRAINTS**

- Children 12 years and under should ride properly buckled up in a rear seat, if available. According to crash statistics, children are safer when properly restrained in the rear seats rather than in the front.
- Every state in the United States and all Canadian provinces require that small children ride in proper restraint systems. This is the law, and you can be prosecuted for ignoring it.

### **Installing The LATCH - Compatible Child Restraint System**

- Your vehicle's second row passenger seats are equipped with the child restraint anchorage system called LATCH, which stands for Lower Anchors and Tether for Children.
- **Four-Door** models: The rear outboard seating positions have lower anchors, and all three rear seating positions have top tether anchors. Child seats with fixed lower attachments must be installed in the outboard positions only. Child seats with flexible lower attachments can be used in all three seating positions. **Never** install LATCH-compatible child seats such that two seats share a common lower anchorage.
- **Two-door** models can accommodate flexible LATCH-compatible child seats in the two outboard seating positions only. Both rear seating positions have lower anchors and top tether anchors. Child seats with fixed or flexible LATCH-compatible attachments can be installed in either outboard seating position.



- Loosen the child seat adjusters on the lower straps and tether straps so that you can attach the hook or connector to the lower and tether anchorages more easily.
- Attach the lower hooks or connectors over the top of the anchorage bars, pushing aside the seat cover material. You will easily feel the anchorage bars if you run your finger along the intersection of the seatback and seat cushion surfaces.

# GETTING STARTED

- The tether strap should be attached to the tether anchor on the rear of the seatback using the most direct path. For the outboard seating positions, route the tether underneath the head rest and attach the hook to the tether anchor located on the back of the seat.

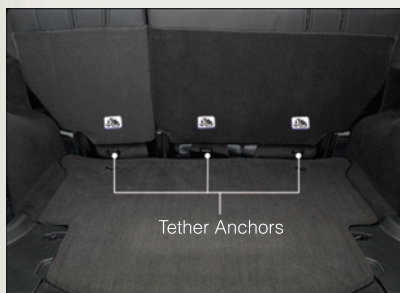

**Four-Door Model**



**Two-Door Model**

- Tighten all three straps as you push the child restraint rearward and downward into the seat.

## Installing The Child Restraint Using The Vehicle Seat Belts

- To install a child restraint, first, pull enough of the seat belt webbing from the retractor to route it through the belt path of the child restraint and slide the latch plate into the buckle.
- Next, extract all the seat belt webbing out of the retractor and then allow the belt to retract into the retractor. Finally, pull on any excess webbing to tighten the lap portion around the child restraint. Any seat belt system will loosen with time, so check the belt occasionally, and pull it tight if necessary.
- Once you have completed securing the child restraint with the seat belt, secure the top tether strap. The tether strap should be attached to the tether anchor on the rear of the seatback using the most direct path. For the outboard seating positions, route the tether underneath the head rest and attach the hook to the tether anchor located on the back of the seat.

# GETTING STARTED

## WARNING!

- In a collision, an unrestrained child, even a tiny baby, can become a projectile inside the vehicle. The force required to hold even an infant on your lap could become so great that you could not hold the child, no matter how strong you are. The child and others could be severely injured or killed. Any child riding in your vehicle should be in a proper restraint for the child's size.
- Improper installation of a child restraint to the LATCH anchorages can lead to failure of an infant or child restraint. The child could be severely injured or killed. Follow the manufacturer's directions exactly when installing an infant or child restraint.
- An incorrectly anchored tether strap could lead to increased head motion and possible injury to the child. Use only the anchor positions directly behind the child seat to secure a child restraint top tether strap.
- Rearward-facing child seats must never be used in the front seat of a vehicle with a front passenger air bag. An air bag deployment could cause infants in this position to be severely injured or killed.

## FRONT SEATS

### Manual Seat Adjustment

#### Forward/Rearward



- Lift up on the adjusting bar located at the front of the seat near the floor and release at the desired position.

# GETTING STARTED

## Height Adjustment



- Ratchet the front lever, located on the outboard side of the seat, upward to raise the seat height.
- Ratchet the lever downward to lower the seat height.

## Recliner

- Lift the recliner lever located on the outboard side of the seat, lean back and release at the desired position.

## Driver's and Passenger Easy Entry Seats (Two-Door)

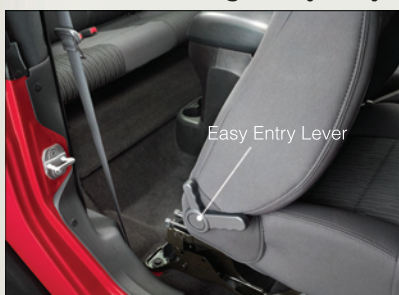

- Push the lever on the seatback rearward (toward the rear of the vehicle) to tilt the entire seat forward.
- To return the seat to a sitting position, rotate the seatback upright until it locks. Push the seat rearward until the track locks.

## NOTE:

- If equipped with a combination lever, the seatback will return to its first locked position. The recliner handle will have to be actuated to adjust the seatback to the desired reclined position.
- The front passenger seats have a track memory which returns the seat to just past the halfway point of the track, regardless of its original position.
- The recliner and easy entry levers should not be used during the automatic returning of the seat to its fully upright position.

## WARNING!

- Adjusting a seat while the vehicle is moving is dangerous. The sudden movement of the seat could cause you to lose control. The seat belt might not be properly adjusted, and you could be severely injured or killed. Only adjust a seat while the vehicle is parked.
- Do not ride with the seatback reclined so that the seat belt is no longer resting against your chest. In a collision, you could slide under the seat belt and be severely injured or killed. Use the recliner only when the vehicle is parked.



# GETTING STARTED

## REAR SEATS

### Folding Rear Seat

- Be sure that the front seats are fully upright and positioned forward. This will allow the rear seat to fold down easily.

#### To Fold The Rear Seat

- Lift the seatback release lever and fold the seatback forward (two-door models).

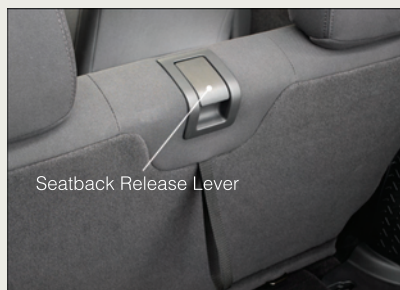

- Slowly flip the entire seat (two-door models) forward.
- Locate the pull strap, located on the outboard side of the seat, and pull it toward you until the seatback releases (four-door models).



#### To Raise The Rear Seat

- Lift up on the seatback to return it to the upright position.

### WARNING!

- It is extremely dangerous to ride in a cargo area, inside or outside of a vehicle. In a collision, people riding in these areas are more likely to be severely injured or killed. Do not allow people to ride in any area of your vehicle that is not equipped with seats and seat belts. Be sure everyone in your vehicle is in a seat and using a seat belt properly.
- Be certain that the seatback is securely locked into position. If the seatback is not securely locked into position, the seat will not provide the proper stability for child seats and/or passengers. An improperly latched seat could cause you or others to be severely injured or killed.

# GETTING STARTED

## TILT STEERING COLUMN



- The tilt lever is located on the steering column, below the turn signal lever.
- Push down on the lever to unlock the steering column.
- With one hand firmly on the steering wheel, move the steering column up or down as desired.
- Pull upward on the lever to lock the column firmly in place.

### WARNING!

Do not adjust the steering column while driving. Adjusting the steering column while driving, or driving with the steering column unlocked, could cause the driver to lose control of the vehicle. Be sure the steering column is locked before driving your vehicle. Failure to follow this warning may result in you or others being severely injured or killed.

## HEATED SEATS

### Front Heated Seats



- The controls for front heated seats are located near the bottom center of the instrument panel (below the heater/air conditioning controls).
  - Press the switch once to select High-level heating. Press the switch a second time to select Low-level heating. Press the switch a third time to shut the heating elements Off.
- If the High-level setting is selected, the system will automatically switch to Low-level after approximately 30 minutes. The Low-level setting will turn Off automatically after approximately 30 minutes.

# GETTING STARTED

## **WARNING!**

- Persons who are unable to feel pain to the skin because of advanced age, chronic illness, diabetes, spinal cord injury, medication, alcohol use, exhaustion or other physical conditions must exercise care when using the seat heater. It may cause burns even at low temperatures, especially if used for long periods of time.
- Do not place anything on the seat that insulates against heat, such as a blanket or cushion. This may cause the seat heater to overheat. Sitting in a seat that has been overheated could cause serious burns due to the increased surface temperature of the seat.

# OPERATING YOUR VEHICLE



## ENGINE BREAK-IN RECOMMENDATIONS

- A long break-in period is not required for the engine and drivetrain (transmission and axle) in your vehicle.
- Drive moderately during the first 300 miles (500 km). After the initial 60 miles (100 km), speeds up to 50 or 55 mph (80 or 90 km/h) are desirable.
- While cruising, brief full-throttle acceleration within the limits of local traffic laws contributes to a good break-in. Wide-open throttle acceleration in low gear can be detrimental and should be avoided.
- The engine oil installed in the engine at the factory is a high-quality energy conserving type lubricant. Oil changes should be consistent with anticipated climate conditions under which vehicle operations will occur. For the recommended viscosity and quality grades, refer to “Maintaining Your Vehicle”. NON-DETERGENT OR STRAIGHT MINERAL OILS MUST NEVER BE USED.
- A new engine may consume some oil during its first few thousand miles (kilometers) of operation. This should be considered a normal part of the break-in and not interpreted as an indication of difficulty.

## TURN SIGNAL/LIGHTS LEVER



### Headlights/Parking Lights/Automatic Headlights

- Rotate the end of the lever to the first detent for parking lights , the second detent for headlights  and the third detent for AUTO.
- When set to AUTO, the system automatically turns the headlights on or off based on ambient light levels.

### Instrument Panel Dimmer

- Rotate the center portion of the lever to the extreme bottom position to fully dim the instrument panel lights and prevent the interior lights from illuminating when a door is opened.

# OPERATING YOUR VEHICLE

- Rotate the center portion of the lever up to increase the brightness of the instrument panel lights when the parking lights or headlights are on.
- Rotate the center portion of the lever upward to the next detent position to brighten the odometer and radio controls when the parking lights or headlights are on.
- Rotate the center portion of the lever upward to the last detent to turn on the interior lighting.

## Flash To Pass

- Pull the lever toward you to activate the high beams. The high beams will remain on until the lever is released.

## High Beam Operation

- Push the lever forward to activate the high beams.

**NOTE:** For safe driving, turn off the high beams when oncoming traffic is present to prevent headlight glare and as a courtesy to other motorists.

## Fog Lights

- Turn on the parking lights or low beam headlights and pull out the end of the lever.

## Turn Signals/Lane Change Assist

- Tap the lever up or down once and the turn signal (right or left) will flash three times and automatically turn off.

## WIPER/WASHER LEVER



## Front Wipers

### Intermittent, Low And High Operation

- Rotate the end of the lever to the first detent position for one of five intermittent settings, the second detent for low wiper operation and the third detent for high wiper operation.

### Washer Operation

- Pull the lever toward you and hold for as long as spray is desired.

# OPERATING YOUR VEHICLE

## Mist

- Pull down on the lever and release when a single wipe is desired.

**NOTE:** The mist feature does not activate the washer pump; therefore, no washer fluid will be sprayed on the windshield. The wash function must be used in order to spray the windshield with washer fluid.

## Rear Wiper

### Wiper Operation

- Rotate the center portion of the lever forward to the first detent for rear wiper operation.

### Washer Operation

- Rotate the center portion of the lever past the first detent to activate the rear washer.

## SPEED CONTROL

- The speed control switches are located on the steering wheel.



### Cruise ON/OFF

- Push the ON/OFF switch to activate the Speed Control.
- The cruise symbol  will appear on the instrument cluster to indicate the Speed Control is on.
- Push the ON/OFF switch a second time to turn the system off.

### Set

- With the Speed Control on, push and release the SET - button to set a desired speed.

### Accel/Decel

- Once a speed is set, pushing the RES + button once or the SET - button once will increase or decrease the set speed approximately 1 mph (2 km/h).
- Push and hold the RES + button to accelerate in 5mph (8 km/h) increments or push and hold the SET - button to decelerate in 5mph (8 km/h) increments; release the button to save the new set speed.

### Resume

- To resume a previously selected set speed in memory, push the RES + button and release.

# OPERATING YOUR VEHICLE

## Cancel

- Push the CANCEL switch, or apply the brakes or clutch, to cancel the set speed and maintain the set speed memory.
- Push the ON/OFF switch to turn the system off and erase the set speed memory.

## MANUAL CLIMATE CONTROLS



## Air Recirculation

- Use recirculation for maximum A/C operation.
- For window defogging, turn the recirculation button off.
- Recirculation is not allowed in defrost, floor, defrost/floor (mix) modes.

## Heated Mirrors

- The mirrors are heated to melt frost or ice. This feature is activated whenever you turn on the rear window defroster.

# OPERATING YOUR VEHICLE

## AUTOMATIC TEMPERATURE CONTROLS (ATC)

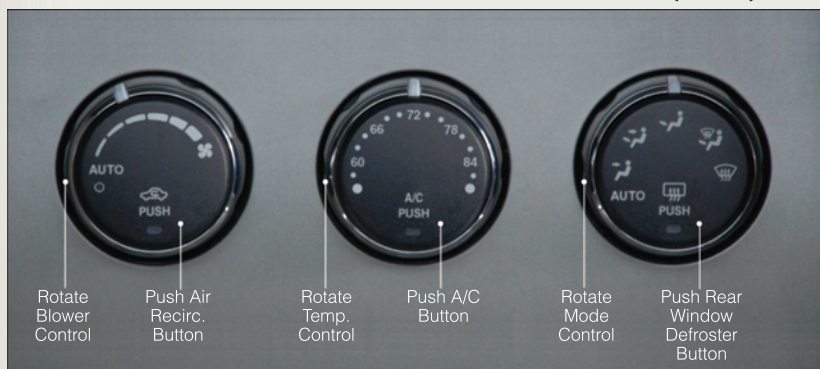

### Automatic Operation

- Turn the Mode and Blower Controls to the AUTO position.
- Select the desired temperature by rotating the Temperature Control.
- The system will maintain the set temperature automatically.

### Air Conditioning (A/C)

- If the air conditioning button is pressed while in the AUTO mode, the indicator light may flash three times to indicate the cabin air is being controlled automatically.

### Air Recirculation

- Use recirculation for maximum A/C operation.
- For window defogging, turn the air recirculation button off.
- If the recirculation button is pressed while in the AUTO mode, the indicator light may flash three times to indicate the cabin air is being controlled automatically.

### Heated Mirrors

- The mirrors are heated to melt frost or ice. This feature is activated whenever you turn on the rear window defroster.



# OPERATING YOUR VEHICLE

## SOFT TOP AND SUNRIDER®



\*Refer to your Owner's Manual on the DVD for complete instructions.

# OPERATING YOUR VEHICLE

## 2-DOOR SOFT TOP DOWN

5) Release body side retainer and door panel retainer – remove quarter window.

6) Un-tuck sail panels and fold up so they are resting on top of the vehicle.

7) Unlatch the side bows from the door panel by pressing on the latch panel from behind.

NOTE: Make sure the plastic sleeve is in place over the Sunrider® link.

1) Unclip sun visors and move out of the way. Release header latches from the windshield frame.

8) Lower the top so the sides form a “V” shape.

2) Open swing gate and pull open the first three inches of the sail panel on both sides.

3) Partially unzip rear window on the passenger side and pull the tailgate bar straight back. Finish unzipping rear window. Remove rear window.

4) Release Velcro® flaps and unzip quarter window from lower rear corner.



\*Refer to your Owner's Manual on the DVD for complete instructions.

# OPERATING YOUR VEHICLE

## 4-DOOR SUNRIDER® DOWN

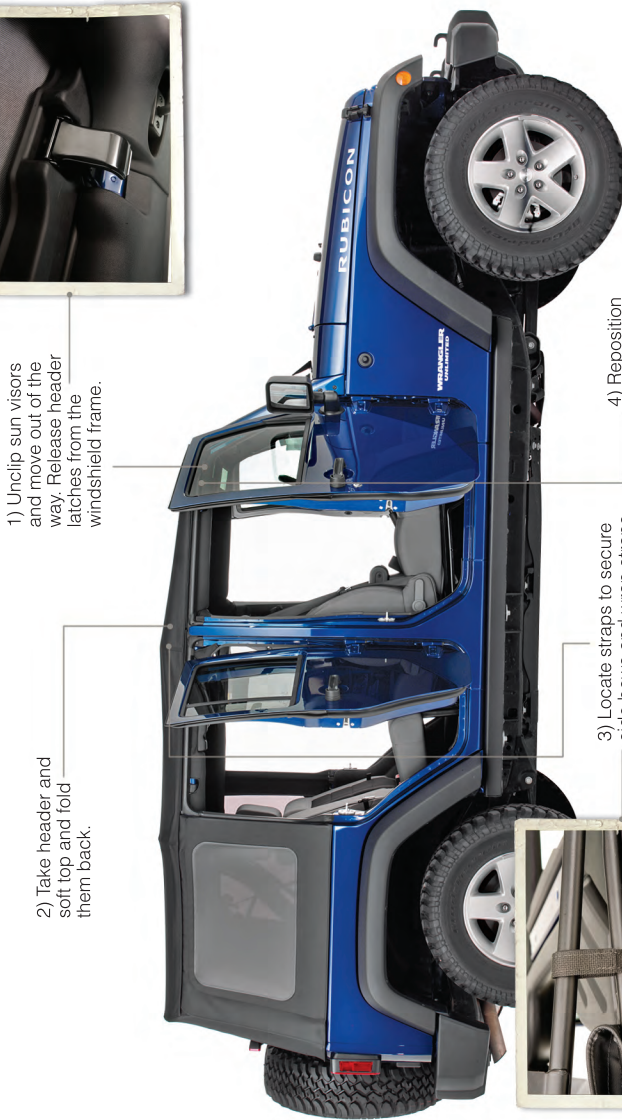

1) Unclip sun visors and move out of the way. Release header latches from the windshield frame.

2) Take header and soft top and fold them back.

3) Locate straps to secure side bows and wrap straps around bows on both sides.

4) Reposition the sun visors.

\*Refer to your Owner's Manual on the DVD for complete instructions.

# OPERATING YOUR VEHICLE

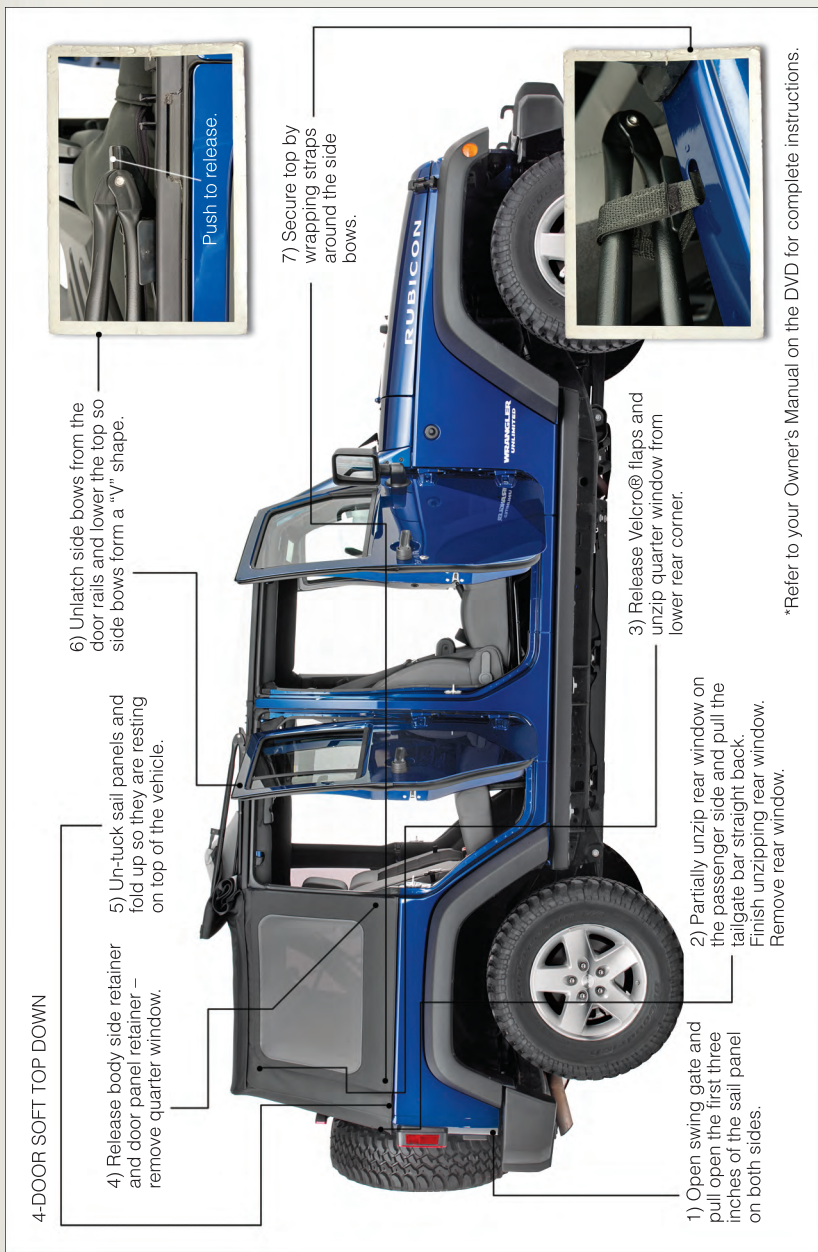

4-DOOR SOFT TOP DOWN

4) Release body side retainer and door panel retainer – remove quarter window.

5) Un-tuck sail panels and fold up so they are resting on top of the vehicle.

6) Unlatch side bows from the door rails and lower the top so side bows form a "V" shape.

7) Secure top by wrapping straps around the side bows.



1) Open swing gate and pull open the first three inches of the sail panel on both sides.

2) Partially unzip rear window on the passenger side and pull the tailgate bar straight back. Finish unzipping rear window. Remove rear window.

3) Release Velcro® flaps and unzip quarter window from lower rear corner.



\*Refer to your Owner's Manual on the DVD for complete instructions.

# OPERATING YOUR VEHICLE

## HARD TOP AND FREEDOM TOP®

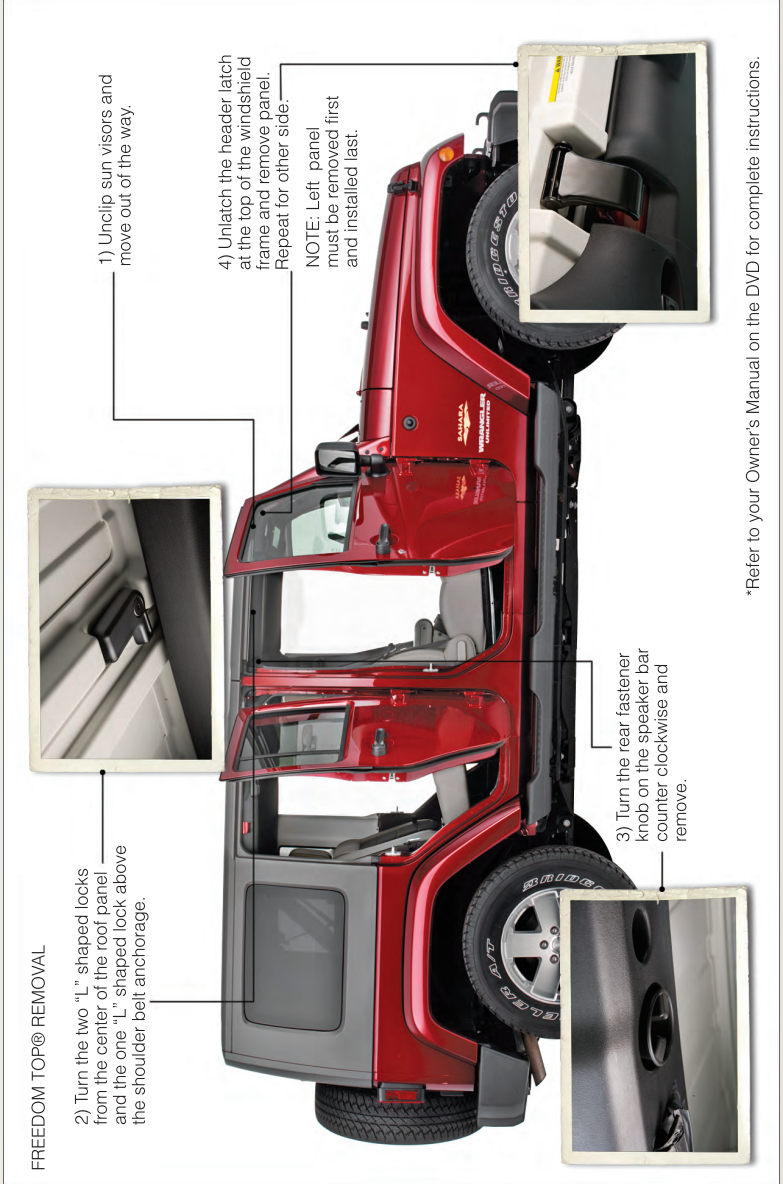

# OPERATING YOUR VEHICLE

## FREEDOM TOP® REMOVAL

2) Turn the two "L" shaped locks from the center of the roof panel and the one "L" shaped lock above the shoulder belt anchorage.



1) Unclip sun visors and move out of the way.

4) Unlatch the header latch at the top of the windshield frame and remove panel. Repeat for other side.

NOTE: Left panel must be removed first and installed last.



3) Turn the rear fastener knob on the speaker bar counter clockwise and remove.



\*Refer to your Owner's Manual on the DVD for complete instructions.

# OPERATING YOUR VEHICLE

## **WIND BUFFETING**

- Wind buffeting can be described as a helicopter-type percussion sound. If buffeting occurs with the rear windows open, adjust the front and rear windows together.

# ELECTRONICS

## YOUR VEHICLE'S SOUND SYSTEM



Bluetooth Streaming Audio – allows you to control your Bluetooth device through the radio, steering wheel audio controls or voice commands. See Uconnect™ Phone in this section for more details.

Also, Bluetooth device must be compatible. Refer to your Bluetooth device's manual to see if it supports A2DP+AVCRP 1.3 protocol.



# ELECTRONICS



USB Port on Radio – for copying files from a memory stick to your radio's hard drive.

Audio Jack – works with iPod® devices or other players with a headphones jack and a 3.5mm cable.

Your Radio Sales Code

USB Port (located inside center console) – when connected, allows you to control your iPod® or memory stick using the radio or steering wheel audio controls.

# ELECTRONICS

## Media Center 130 (Sales Code RES)

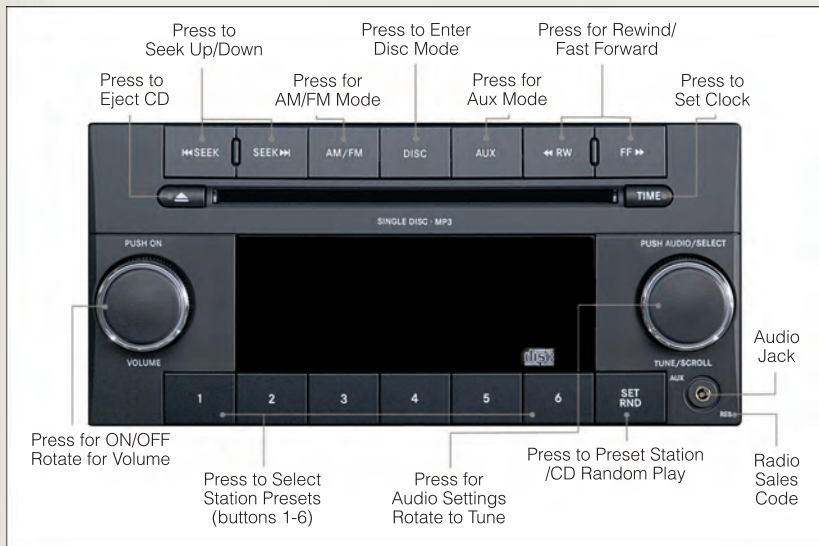

### NOTE:

- Your radio has many features that add to the comfort and convenience of you and your passengers. Some of these radio features should not be used when driving because they take your eyes from the road or your attention from driving.

### Clock Setting

- Press and hold the "TIME" button until the hours blink; turn the "TUNE/SCROLL" control knob to set the hours.
- Press the "TUNE/SCROLL" control knob until the minutes begin to blink; turn the "TUNE/SCROLL" control knob to set the minutes.
- Press the "TUNE/SCROLL" control knob to save the time change.
- To exit, press any button/knob or wait five seconds.

### Equalizer, Balance And Fade

- Press the "TUNE/SCROLL" control knob and BASS, MID, TREBLE, BALANCE and FADE will display. Rotate the "TUNE/SCROLL" control knob to select the desired setting.

### Radio Operation

#### Seek Up/Down Buttons

- Press to seek through radio stations in AM, FM, or SAT bands.
- Hold either button to bypass stations without stopping.

# ELECTRONICS

## **Store Radio Presets**

- Press the “SET/RND” button once and SET 1 will show in the display. Then select button (1-6).
- A second station may be added to each push button. Press the “SET/RND” button twice and SET 2 will show in the display. Then select button (1-6).

## **CD/DISC Operation**

### **Seek Up/Down Buttons**

- Press to seek through CD tracks.
- Hold either button to bypass tracks without stopping.

### **SET/RND Button (Random Play)**

- Press this button while the CD is playing to activate Random Play.
- This feature plays the selections on the CD in random order to provide an interesting change of pace.

## **Audio Jack Operation**

- The Audio Jack allows a portable device, such as an MP3 player or a cassette player, to be plugged into the radio and utilize the vehicle’s audio system, using a 3.5 mm audio cable, to amplify the source and play through the vehicle speakers.
- Pressing the “AUX” button will change the mode to auxiliary device if the Audio Jack is connected, allowing the music from your portable device to play through the vehicle’s speakers.
- The functions of the portable device are controlled using the device buttons. The volume may be controlled using the radio or portable device.

# ELECTRONICS

## Media Center 130 with Satellite Radio (Sales Code RES + RSC)

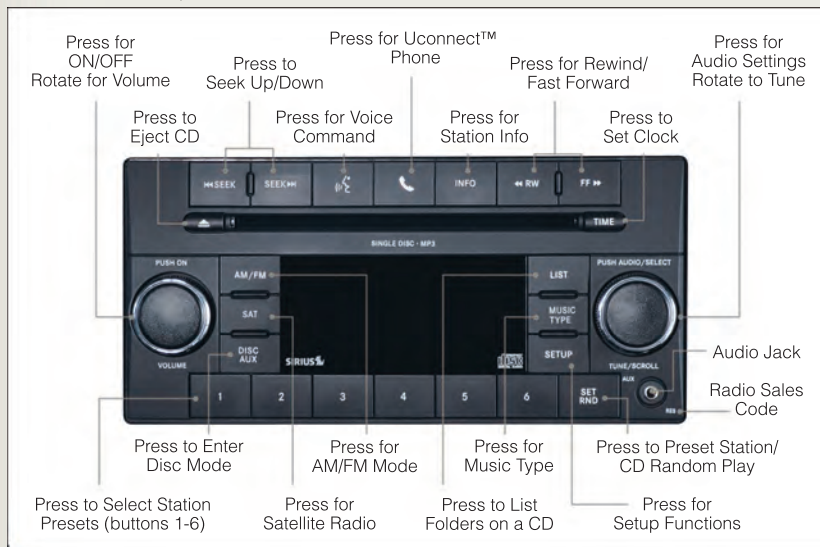

### NOTE:

- Your radio may not be equipped with the Uconnect™ Voice Command and Uconnect™ Phone features. To determine if your radio has these features, press the Voice Command button on the radio. You will hear a voice prompt if you have the feature, or see a message on the radio stating “Uconnect Phone not available” if you do not.
- Your radio has many features that add to the comfort and convenience of you and your passengers. Some of these radio features should not be used when driving because they take your eyes from the road or your attention from driving.

### Clock Setting

- Press and hold the “TIME” button until the hours blink; turn the “TUNE/SCROLL” control knob to set the hours.
- Press the “TUNE/SCROLL” control knob until the minutes begin to blink; turn the “TUNE/SCROLL” control knob to set the minutes.
- Press the “TUNE/SCROLL” control knob to save the time change.
- To exit, press any button/knob or wait five seconds.

### Equalizer, Balance And Fade

- Press the “TUNE/SCROLL” control knob and BASS, MID, TREBLE, BALANCE and FADE will display. Rotate the “TUNE/SCROLL” control knob to select the desired setting.

## Radio Operation

### Seek Up/Down Buttons

- Press to seek through radio stations in AM, FM, or SAT bands.
- Hold either button to bypass stations without stopping.

### Store Radio Presets

- Press the “SET/RND” button once and SET 1 will show in the display. Then select button (1-6).
- A second station may be added to each push button. Press the “SET/RND” button twice and SET 2 will show in the display. Then select button (1-6).

### Music Type

- Press the “MUSIC TYPE” button to activate this mode. Press the “MUSIC TYPE” button again or turn the “TUNE/SCROLL” control knob to select the desired music type (Adult Hits, Country, Jazz, Oldies, Rock, etc.).
- Once a music type is chosen and the icon is displayed, press either “SEEK” button and the radio will only search for stations with the selected music type.

**NOTE:** The Music Type function only operates when in FM mode.

### SETUP Button

- Pressing the “SETUP” button allows you to select between items that are available in that particular mode.
- Turn the “TUNE/SCROLL” control knob to scroll through the entries. Push the “AUDIO/SELECT” button to select an entry and make changes.

## SIRIUS Satellite Radio

- SIRIUS Satellite Radio gives you over 130 channels, including 100% commercial-free music from nearly every genre, plus all your favorite sports, news, talk and entertainment channels –all with crystal clear, coast-to-coast coverage, all in one place and all at your fingertips.
- To access SIRIUS Satellite Radio, press the “SAT” hard-key.

## CD/DISC Operation

### Seek Up/Down Buttons

- Press to seek through CD tracks.
- Hold either button to bypass tracks without stopping.

### SET/RND Button (Random Play)

- Press this button while the CD is playing to activate Random Play.
- This feature plays the selections on the CD in random order to provide an interesting change of pace.

# ELECTRONICS

## LIST Button

- Press the “LIST” button to bring up a list of all folders on the CD. Scroll up or down the list by turning the “TUNE/SCROLL” control knob.
- To select a folder from the list, press the “TUNE/SCROLL” control knob and the radio will begin playing the files contained in that folder.

## Audio Jack Operation

- The Audio Jack allows a portable device, such as an MP3 player or a cassette player, to be plugged into the radio and utilize the vehicle’s audio system, using a 3.5 mm audio cable, to amplify the source and play through the vehicle speakers.
- Pressing the “AUX” button will change the mode to auxiliary device if the Audio Jack is connected, allowing the music from your portable device to play through the vehicle’s speakers.
- The functions of the portable device are controlled using the device buttons. The volume may be controlled using the radio or portable device.

## Media Center 230 (Sales Code REQ)

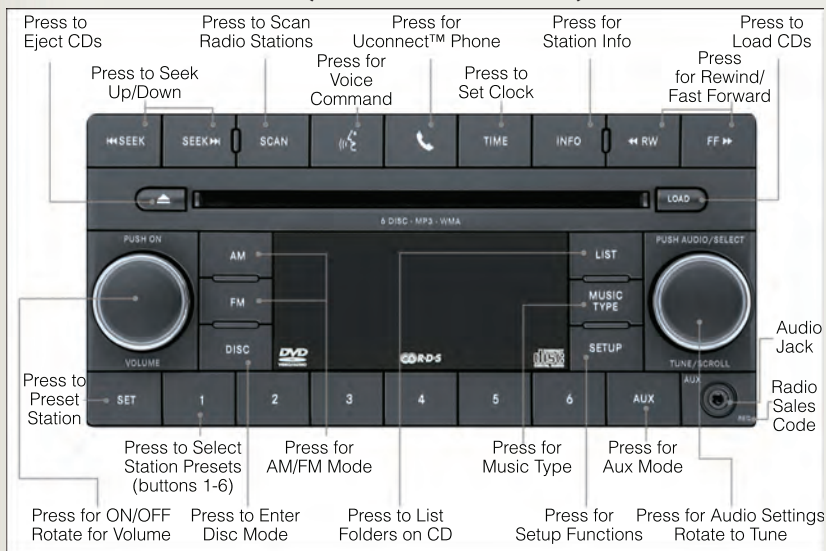

## NOTE:

- Your radio may not be equipped with the Uconnect™ Voice Command and Uconnect™ Phone features. To determine if your radio has these features, press the Voice Command button on the radio. You will hear a voice prompt if you have the feature, or see a message on the radio stating “Uconnect Phone not available” if you do not.

# ELECTRONICS

- Your radio has many features that add to the comfort and convenience of you and your passengers. Some of these radio features should not be used when driving because they take your eyes from the road or your attention from driving.

## Clock Setting

- Press and hold the “TIME” button until the hours blink; turn the “TUNE/SCROLL” control knob to set the hours.
- Press the “TUNE/SCROLL” control knob until the minutes begin to blink; turn the “TUNE/SCROLL” control knob to set the minutes.
- Press the “TUNE/SCROLL” control knob to save the time change.
- To exit, press any button/knob or wait five seconds.

## Equalizer, Balance And Fade

- Press the “TUNE/SCROLL” control knob and BASS, MID, TREBLE, BALANCE and FADE will display. Rotate the “TUNE/SCROLL” control knob to select the desired setting.

## Radio Operation

### Seek Up/Down Buttons

- Press to seek through radio stations in AM, FM, or SAT bands.
- Hold either button to bypass stations without stopping.

### Store Radio Presets

- Press the “SET/RND” button once and SET 1 will show in the display. Then select button (1-6).
- A second station may be added to each push button. Press the “SET/RND” button twice and SET 2 will show in the display. Then select button (1-6).

### Music Type

- Press the “MUSIC TYPE” button to activate this mode. Press the “MUSIC TYPE” button again or turn the “TUNE/SCROLL” control knob to select the desired music type (Adult Hits, Country, Jazz, Oldies, Rock, etc.).
- Once a music type is chosen and the icon is displayed, press the SEEK button and the radio will only search for stations with the selected music type.

**NOTE:** The Music Type function only operates when in FM mode.

### SETUP Button

- Pressing the “SETUP” button allows you to select between items that are available in that particular mode.
- Turn the “TUNE/SCROLL” control knob to scroll through the entries. Push the “AUDIO/SELECT” button to select an entry and make changes.

# ELECTRONICS

## **SIRIUS Satellite Radio**

- SIRIUS Satellite Radio gives you over 130 channels, including 100% commercial-free music from nearly every genre, plus all your favorite sports, news, talk and entertainment channels –all with crystal clear, coast-to-coast coverage, all in one place and all at your fingertips.
- To access SIRIUS Satellite Radio, press the “SAT” hard-key.

## **CD/DISC Operation**

### **Seek Up/Down Buttons**

- Press to seek through CD tracks.
- Hold either button to bypass tracks without stopping.

### **SET/RND Button (Random Play)**

- Press this button while the CD is playing to activate Random Play.
- This feature plays the selections on the CD in random order to provide an interesting change of pace.

### **LIST Button**

- Press the “LIST” button to bring up a list of all folders on the CD. Scroll up or down the list by turning the “TUNE/SCROLL” control knob.
- To select a folder from the list, press the “TUNE/SCROLL” control knob and the radio will begin playing the files contained in that folder.

### **How To Load Multiple CDs/DVDs**

- Press the “LOAD” button and then press the button with the corresponding number (1–6) where the CD is being loaded. The radio will display PLEASE WAIT and prompt when to INSERT DISC.
- After the radio displays INSERT DISC, insert the CD into the player. The radio display will show LOADING DISC when the disc is loading and “READING DISC” when the radio is reading the disc.
- Press the eject button and then the corresponding number (1–6) to eject the desired disc.

## **Audio Jack Operation**

- The Audio Jack allows a portable device, such as an MP3 player or a cassette player, to be plugged into the radio and utilize the vehicle’s audio system, using a 3.5 mm audio cable, to amplify the source and play through the vehicle speakers.
- Pressing the AUX button will change the mode to auxiliary device if the Audio Jack is connected, allowing the music from your portable device to play through the vehicle’s speakers.
- The functions of the portable device are controlled using the device buttons. The volume may be controlled using the radio or portable device.



# ELECTRONICS

## Media Center 430/430N (Sales Code RBZ/RHB)

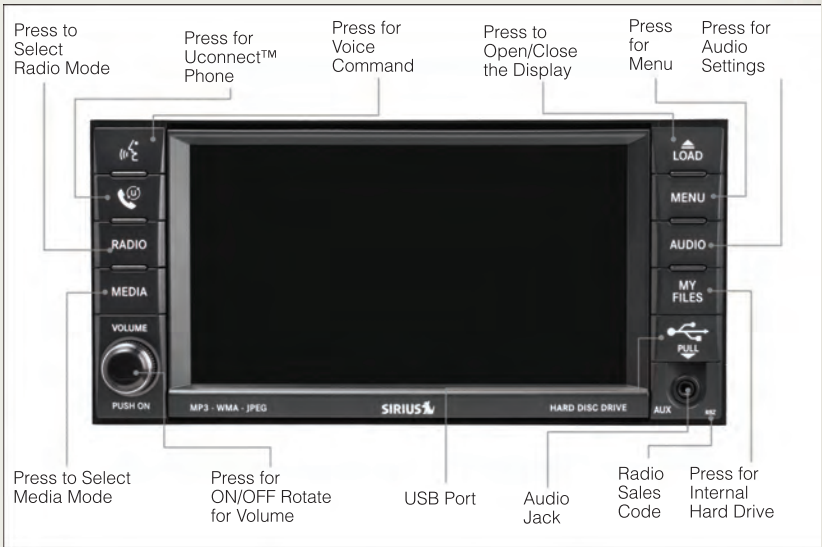

### NOTE:

- Your radio may not be equipped with the Uconnect™ Voice Command and Uconnect™ Phone features. To determine if your radio has these features, press the Voice Command button on the radio. You will hear a voice prompt if you have the feature, or see a message on the radio stating “Uconnect Phone not available” if you do not.
- Your radio has many features that add to the comfort and convenience of you and your passengers. Some of these radio features should not be used when driving because they take your eyes from the road or your attention from driving.

### Clock Setting

- Turn the radio on, then touch the screen where the time is displayed.
- Touch the “USER CLOCK” soft-key (Navigation radio only).
- To adjust the hours, touch either the “HOUR FORWARD” or “HOUR BACKWARD” soft-key.
- To adjust the minutes, touch either the “MINUTE FORWARD” or “MINUTE BACKWARD” soft-key.
- To save the new time setting, touch the screen where the word “Save” is displayed.

### Menu

- Press the “MENU” hard-key to access the System Setup menu and the My Files menu.

# ELECTRONICS

- Press the “MENU” hard-key in an active mode (SAT, CD, AUX, etc.) in order to change mode specific settings.

## Equalizer, Balance And Fade

### Audio Control Menu



- Press the “AUDIO” hard-key on the right side of the radio.
- Use either the arrow soft-keys or the cross-hair on the screen to change Balance and Fade. The “CENTER” soft-key resets the settings.

- Touch the “Equalizer” soft-key and use either the arrow soft-keys or the sliders on the screen to adjust BASS, MID, and/or TREBLE.

## Display Settings

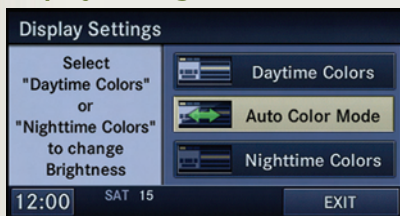

- Press the “MENU” hard-key and touch the “Display Settings” soft-key to access the Display Settings menu.
- Select the “Daytime Colors” soft-key to switch to manual daytime mode and to adjust the brightness of the display using daytime colors.

- Select the “Nighttime Colors” soft-key to switch to manual nighttime mode and to adjust the brightness of the display using nighttime colors.
- Select the “Auto Color Mode” soft-key to switch to automatic daytime/nighttime mode and to control the brightness of the display using the dimmer switch of the vehicle.
- Touch the “EXIT” soft-key to save your settings.

## Radio Operation

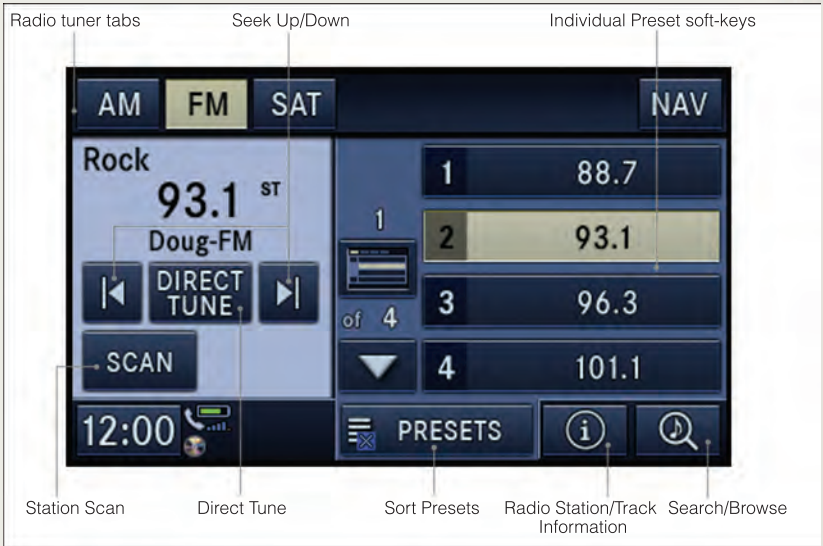

- To access Radio Mode, touch the “RADIO” hard-key on the right side of the faceplate, then touch the “AM,” “FM” or “SAT” soft-key at the top of the screen to select the band.

### Seek Up/Seek Down

- Press the “Seek Up” or “Seek Down” soft-keys to seek through radio stations in AM, FM, or SAT bands. Hold either Seek to bypass stations without stopping.

### Store Radio Presets

- Select the radio band by touching either the “AM,” “FM,” or “SAT” soft-key.
- Find the station to store by either pressing the “Seek Up” or “Seek Down” soft-keys, touching the “SCAN” soft-key, or by using the “DIRECT TUNE” soft-key.
- Once the station is found, touch and hold one of the “PRESET” soft-keys in the list to the right, until you hear a confirmation beep.

**NOTE:** If the Presets are not visible on the right side of the screen, press the “Presets” soft-key.

# ELECTRONICS

## CD/DVD Disc Operation



- Press the “MEDIA” hard key to display the media source tabs at the top of the screen. Select the source by touching the “HDD,” “DISC,” or “AUX” media source soft-key tab.

**NOTE:** Your Touch-Screen Radio will usually automatically switch to the appropriate mode when something is first connected or inserted into the system.

### Insert a CD/DVD Disc

- To insert a disc, press the or “LOAD” hard-key.
- With the printed side upwards, insert the disc into the disc slot of the radio. The radio pulls the disc in automatically and closes the flip screen. The radio selects the appropriate mode after the disc is recognized, and starts playing the first track. The display shows “Reading...” during this process.

### Seek Up/Seek Down

- Press the “Seek Up” or “Seek Down” soft-keys to seek through tracks in Disc Mode. Hold either Seek to bypass tracks without stopping.

## Audio Jack Operation

- The Audio Jack allows a portable device, such as an MP3 player or a cassette player, to be plugged into the radio and utilize the vehicle’s audio system, using a 3.5 mm audio cable, to amplify the source and play through the vehicle speakers.

# ELECTRONICS

- Pressing the “MEDIA” hard-key and then the “AUX” soft-key to change the mode to auxiliary device if the Audio Jack is connected, allowing the music from your portable device to play through the vehicle’s speakers.
- The functions of the portable device are controlled using the device buttons. The volume may be controlled using the radio or portable device.

## Hard Disk Drive (HDD) Operation

- The Hard Disk Drive (HDD) mode gives you access to the audio files on the internal hard disk drive. It functions similar to a CD player, with the exception that the internal HDD can hold more tracks.
- It is also possible to import display pictures to the internal hard disk drive. The pictures can be displayed on the right half of the radio screen.
- Before using the HDD mode, you will need to copy songs and pictures to the internal hard drive. Songs and pictures can be added to the hard drive by using a CD or USB device (e.g. thumb drive or memory stick).

**NOTE:** WMA/MP3 Files and Selective Songs from a CD can also be added to the HDD. See the Media Center 430/430N User’s Manual for more information.

### Copying Music From CD

- Press the “LOAD” hard-key.
- Insert a disc, then press the “MENU” hard-key.



- Touch the “MY FILES” soft-key, then select “MY MUSIC.”

- Touch the “Add Music Files to HDD” soft-key, then touch the “From Disc” soft-key in the next screen to start the process.



### NOTE:

- You might need to select the folder or title depending on the CD, then press “DONE” to start the copy process.
- The copy progress is shown in the lower left corner of the screen.

# ELECTRONICS

## Copying Music From USB

- The USB port on the radio face plate allows you to copy files to your hard drive. To access, lift up on the cover.
- Insert a USB device (e.g. thumb drive or memory stick), then select “MY MUSIC.”
- Touch the “Add Music Files to HDD” soft-key, then touch the “From USB” soft-key in the next screen.

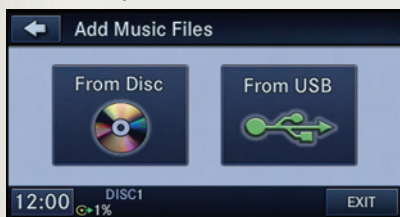

- Select the folders or titles you would like to copy, then touch the “DONE” soft-key to start the copy process.

**NOTE:** The copy progress is shown in the lower left corner of the screen.

## Copying Pictures To The HDD

- Insert either a CD or a USB device containing your pictures in JPEG format.
- Press the “MY FILES” hard-key.
- Touch the “My Pictures” soft-key to get an overview of the currently stored images, then touch the “Add” soft-key.

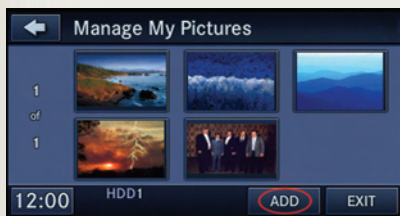

- Touch the “DISC” or “From USB” soft-key, then select the folders or pictures you wish to copy to the HDD. Use the “PAGE” soft-keys to page through the list of pictures.
- Touch the desired pictures or press the “All” soft-key for all pictures. Confirm your selections by touching the “SAVE” soft key.

**NOTE:** The copy progress is shown in the lower left corner of the screen.

## Display a Picture on the Radio Screen

- Once the import is complete, the pictures will then be available in the “MY PICTURES” screen.
- Press the “MY FILES” hard-key, then touch the “My Pictures” soft-key. Touch the desired picture, then touch the “Set as Picture View” soft-key and then touch the “Exit” soft-key. Lastly press the “MENU” hard-key and then touch the “Picture View” soft-key to display the chosen picture on the radio screen.

### **NOTE:**

- A check mark in the My Pictures screen indicates the currently used picture.
- You can also delete pictures by touching the “Delete” soft-key.

# ELECTRONICS

## Playing Music From The HDD



- Press the “MEDIA” hard key to display the media source tabs at the top of the screen. Touch the “HDD” soft-key tab. Touch the desired track soft-key to play or touch the “SEARCH/BROWSE” soft-key to search by artist, by album, by song, by genre, from a folder, or from Favorites.

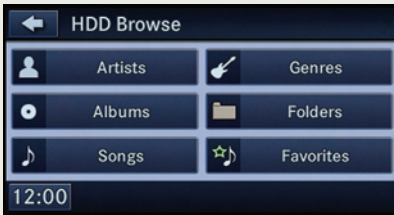

## Cleaning Your Touch-Screen Radio

- Do not spray any liquid or caustic chemicals directly on the screen. Use a clean and dry micro fiber lens cleaning cloth in order to clean the touch-screen.
- If necessary, use a lint-free cloth dampened with a cleaning solution such as isopropyl alcohol or an isopropyl alcohol and water solution ratio of 50:50. Be sure to follow the solvent manufacturer’s precautions and directions.

## Garmin® Navigation

- Media Center 430N integrates Garmin’s consumer-friendly navigation into your vehicle. Garmin Navigation includes a database with over 6 million points of interest.
- Touch the “NAV” soft-key in the upper right corner of the screen to access the Navigation system

**NOTE:** For your own safety and the safety of others, it is not possible to use the certain features while the vehicle is in motion.



# ELECTRONICS

## Main Navigation Menu

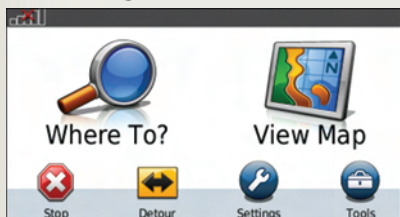

## Finding Points Of Interest

- From the main Navigation menu, touch “Where To?,” then touch “Points of Interest.”
- Select a Category and then a subcategory, if necessary.
- Select your destination and touch “Go.”

## Finding A Place By Spelling The Name

- From the Main Navigation Menu, touch “Where to?,” then touch “Points of Interest” and then touch “Spell Name.”
- Enter the name of your destination.
- Touch “Done.”
- Select your destination and touch “Go.”

## Entering A Destination Address

- From the main Navigation menu, touch “Where To?,” then touch “Address.”
- Follow the on-screen prompts to enter the address and touch “Go.”

## Searching Near Another Location

- From the main Navigation menu, touch “Where To?,” then touch a destination and then touch “Near.”
- Select an option from the available choices.



# ELECTRONICS

## Following Your Route

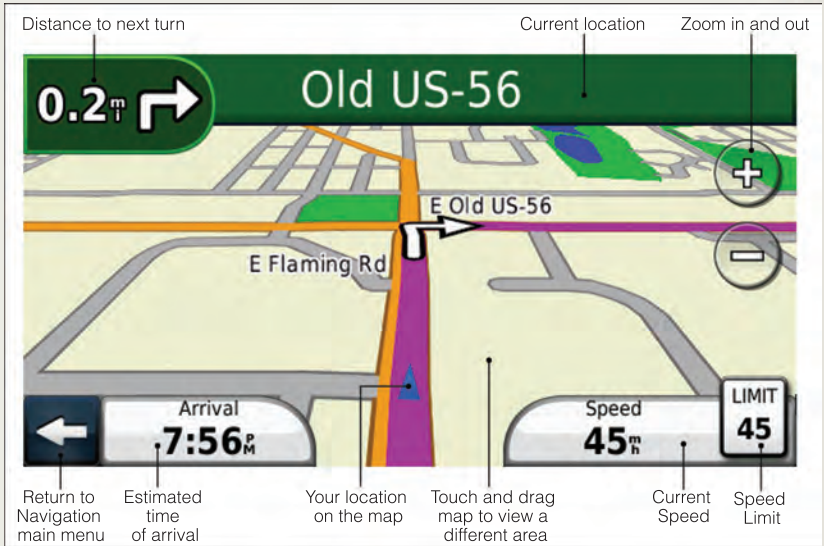

- Your route is marked with a magenta line on the map. If you depart from the original route, your route is recalculated. A speed limit icon could appear as you travel on major roadways.

## Adding A Via Point

- To add a stop (Via Point) you must be navigating a route.
- Touch the “back arrow icon” to return to the Main Navigation menu.
- Touch “Where To?,” then search for the extra stop. Then select the stop to add from the search results.
- Touch “Go,” then touch “Add to Current Route.”

## Taking A Detour

- To take a detour you must be navigating a route
- Touch the “back arrow” icon to return to the Main Navigation menu.
- Touch “Detour.”

**NOTE:** If the route you are currently taking is the only reasonable option, the device might not calculate a detour.

## Setting Your Home Location

- From the main Navigation menu, touch “Where To?,” then touch “Go Home.”
- You may enter your address directly, use your current location as your home address, or choose from recently found locations.

# ELECTRONICS

## Edit Home Location

- From the main Navigation menu, touch “Where To?,” then touch “Favorites.”
- Next, touch the location you would like to edit, then touch “Press for More,” and then “Edit.”

## Go Home

- A Home location must be saved in the system. From the Main Navigation menu, touch “Where To?,” then touch “Go Home.”

## Acquiring Satellites

- The GPS Satellite strength bars indicate the strength of your satellite reception.
- Acquiring satellite signals can take a few minutes. When at least one of the bars is green, your device has acquired satellite signals.
- You may experience delays in acquisition of satellite signals when in areas with an obstructed view to the sky, such as garages, tunnels, or large cities with tall buildings.

## Media Center 730N (Sales Code RHR)

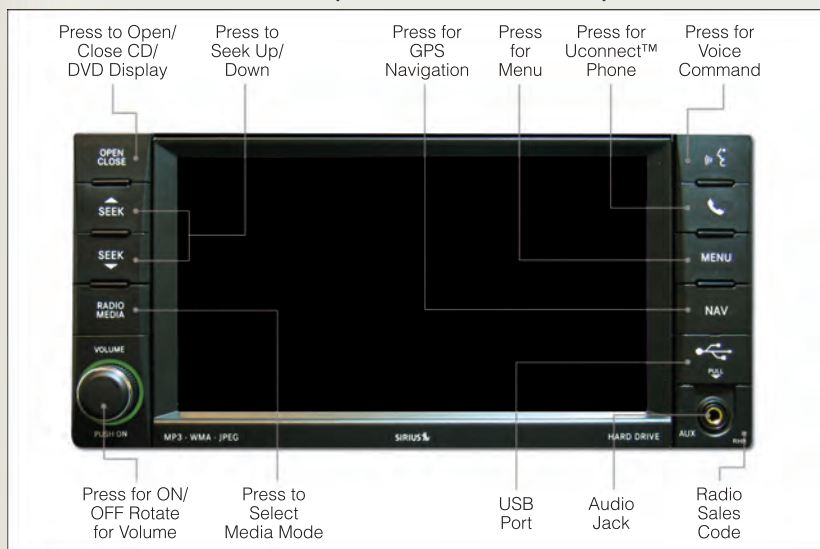

**NOTE:** Your radio may not be equipped with the Uconnect™ Voice Command and Uconnect™ Phone features. To determine if your radio has these features, press the Voice Command button on the radio. You will hear a voice prompt if you have the feature, or see a message on the radio stating “Uconnect Phone not available” if you do not.

# ELECTRONICS

- Your radio has many features that add to the comfort and convenience of you and your passengers. Some of these radio features should not be used when driving because they take your eyes from the road or your attention from driving.

## Clock Setting

- Turn the radio on, then touch the screen where the time is displayed.
- Touch the “USER CLOCK” soft-key.
- To adjust the hours, touch either the “HOUR FORWARD” or “HOUR BACKWARD” soft-key.
- To adjust the minutes, touch either the “MINUTE FORWARD” or “MINUTE BACKWARD” soft-key.
- To save the new time setting, touch the screen where the word “Save” is displayed.

## Menu

- Press the “MENU” hard-key to access the System Setup menu and the My Files menu.
- Press the “MENU” hard-key in an active mode (SAT, CD, AUX, etc.) in order to change mode specific settings.

## Equalizer, Balance And Fade

### Audio Control Menu



- Press the “MENU” hard-key on the right side of the radio. Then press the “Audio Control” soft-key to get to the audio control menu.
- Use either the arrow soft-keys or the cross-hair on the screen to change Balance and Fade. The “CENTER” soft-key resets the settings.

- Touch the “Equalizer” soft-key and use either the arrow soft-keys or the sliders on the screen to adjust BASS, MID, and/or TREBLE.

## Display Settings



- Press the “MENU” hard-key and touch the Display Settings soft-key to access the Display Settings menu.
- Select the “Daytime Colors” soft-key to switch to manual daytime mode and to adjust the brightness of the display using daytime colors.

- Select the “Nighttime Colors” soft-key to switch to manual nighttime mode and to adjust the brightness of the display using nighttime colors.

# ELECTRONICS

- Select the “Auto Color Mode” soft-key to switch to automatic daytime/nighttime mode and to control the brightness of the display using the dimmer switch of the vehicle.
- Touch the “EXIT” soft-key to save your settings.

## Radio Operation

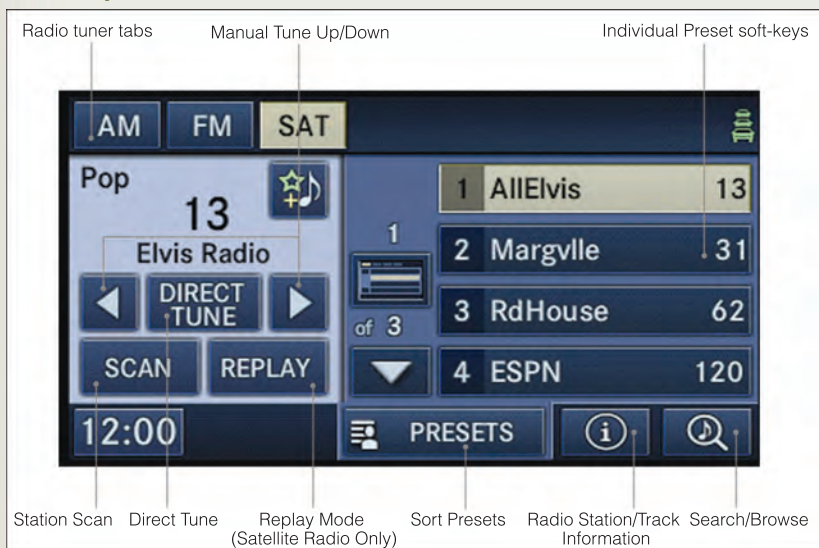

- To access Radio Mode, touch the “RADIO/MEDIA” hard-key on the right side of the faceplate repeatedly until AM/FM/SAT appears at the top of the screen, then touch the “AM,” “FM” or “SAT” soft-key to select the band.

### Seek Up/Seek Down

- Press the “Seek Up” or “Seek Down” hard-keys to seek through radio stations in AM, FM, or SAT bands. Hold either Seek to bypass stations without stopping.

### Store Radio Presets

- Select the radio band by touching either the “AM,” “FM,” or “SAT” soft-key.
- Find the station to store by either pressing the “Seek Up” or “Seek Down” hard-keys, touching the “SCAN” soft-key, or by using the “DIRECT TUNE” soft-key.
- Once the station is found, touch and hold one of the PRESET soft-keys in the list to the right, until you hear a confirmation beep.

# ELECTRONICS

**NOTE:** If the Presets are not visible on the right side of the screen, press the “Presets” soft-key.

## CD/DVD Disc Operation



- Press the “RADIO/MEDIA” hard key until the media source tabs are displayed at the top of the screen. Select the source by touching the “HDD,” “DISC,” or “AUX” media source soft-key tab.

**NOTE:** Your Touch-Screen Radio will usually automatically switch to the appropriate mode when something is first connected or inserted into the system.

### Insert a CD/DVD Disc

- To insert a disc, press the “OPEN/CLOSE” hard-key
- With the printed side upwards, insert the disc into the disc slot of the radio. The radio pulls the disc in automatically and closes the flip screen. The radio selects the appropriate mode after the disc is recognized, and starts playing the first track. The display shows “Reading...” during this process.

### Seek Up/Seek Down

- Press the “Seek Up” or “Seek Down” hard-keys to seek through tracks in Disc Mode. Hold either Seek to bypass tracks without stopping.

# ELECTRONICS

## Audio Jack Operation

- The Audio Jack allows a portable device, such as an MP3 player or a cassette player, to be plugged into the radio and utilize the vehicle's audio system, using a 3.5 mm audio cable, to amplify the source and play through the vehicle speakers.
- Pressing the "RADIO/MEDIA" hard-key and then the "AUX" soft-key to change the mode to auxiliary device if the Audio Jack is connected, allowing the music from your portable device to play through the vehicle's speakers.
- The functions of the portable device are controlled using the device buttons. The volume may be controlled using the radio or portable device.

## Hard Disk Drive (HDD) Operation

- The Hard Disk Drive (HDD) mode gives you access to the audio files on the internal hard disk drive. It functions similar to a CD player, with the exception that the internal HDD can hold more tracks.
- It is also possible to import display pictures to the internal hard disk drive. The pictures can be displayed on the right half of the radio screen.
- Before using the HDD mode, you will need to copy songs and pictures to the internal hard drive. Songs and pictures can be added to the hard drive by using a CD or USB device (e.g. thumb drive or memory stick).

**NOTE:** WMA/MP3 Files and Selective Songs from a CD can also be added to the HDD. See the Media Center 730N User's Manual for more information.

### Copying Music From CD

- Press the "OPEN/CLOSE" hard-key.
- Insert a disc, then press the "MENU" hard-key.
- Touch the "MY FILES" soft-key, then select "MY MUSIC."

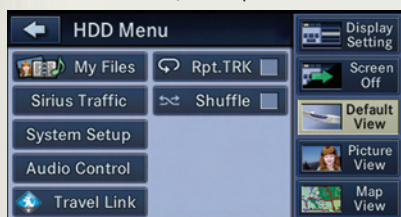

# ELECTRONICS

- Touch the “Add Music Files to HDD” soft-key, then touch the “From Disc” soft-key in the next screen to start the process.



**NOTE:**

- You might need to select the folder or title depending on the CD, then press “Done” to start the copy process.
- The copy progress is shown in the lower left corner of the screen.

## Copying Music From USB

- The USB port on the radio face plate allows you to copy files to your hard drive. To access, lift up on the cover.
- Insert a USB device (e.g. thumb drive or memory stick), then select “MY FILES”.



- Touch the “MY MUSIC” soft-key, then touch the “Add Music Files” to HDD soft-key.
- Touch “From USB” soft-key, then select the folders or titles you would like to copy, and then touch the “SAVE” soft-key to start the copy process.



**NOTE:** The copy progress is shown in the lower left corner of the screen.

## Copying Pictures To The HDD

- Insert either a CD or a USB device containing your pictures in JPEG format.
- Press the “MENU” hard-key to access the Settings Menu, then touch the “My Files” soft-key.
- Touch the “My Pictures” soft-key to get an overview of the currently stored images, then touch the “Add” soft-key.

# ELECTRONICS



- Touch the “DISC” or “From USB” soft-key, then select the folders or pictures you wish to copy to the HDD. Use the “PAGE” soft-keys to page through the list of pictures.
- Touch the desired pictures or press the “All” soft-key for all pictures. Confirm your selections by touching the “SAVE” soft key.

**NOTE:** The copy progress is shown in the lower left corner of the screen.

## Display a Picture on the Radio Screen

- Once the import is complete, the pictures will then be available in the “MY PICTURES” screen.
- Press the “MENU” hard-key to access the Settings Menu, then touch the “My Files” soft-key and then touch the “My Pictures” soft-key. Touch the desired picture, then touch the “Set as Picture View” soft-key and then touch the “Exit” soft-key. Lastly press the “MENU” hard-key and then touch the “Picture View” soft-key to display the chosen picture on the radio screen.

## NOTE:

- A check mark in the My Pictures screen indicates the currently used picture.
- You can also delete pictures by touching the “Delete” soft-key.

## Playing Music From The HDD



- Press the “RADIO/MEDIA” hard key until the media source tabs are displayed at the top of the screen. Touch the “HDD” soft-key tab. Touch the desired track soft-key to play or touch the “SEARCH/BROWSE” soft-key to search by artist, by album, by song, by genre, from a folder, or from Favorites.

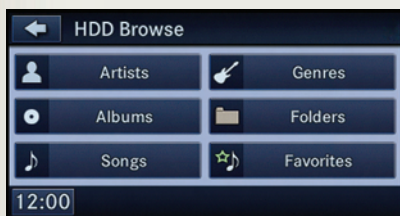



# ELECTRONICS

## Cleaning Your Touch-Screen Radio

- Do not spray any liquid or caustic chemicals directly on the screen. Use a clean and dry micro fiber lens cleaning cloth in order to clean the touch-screen.
- If necessary, use a lint-free cloth dampened with a cleaning solution such as isopropyl alcohol or an isopropyl alcohol and water solution ratio of 50:50. Be sure to follow the solvent manufacturer's precautions and directions.

## NAVIGATION

- Your navigation system receives GPS signals from up to 16 satellites to display the position of your vehicle. Map and database information is supplied through a hard disk drive.
- Touch the "NAV" hard-key on the radio face plate to access the Navigation system and the NAV - Main Menu

**NOTE:** For your own safety and the safety of others, it is not possible to use the certain features while the vehicle is in motion.



## Main Navigation Menu

Program a new destination	Route to a destination you programmed before	Search destination by Point of Interest	Enter or select a favorite Point of Interest

**NAV - Main Menu**

**New Destination**

**Recent Places**

**My Trips**

**Guide Me Home**

**Point of Interest**

**Favorite POI's**

**Emergency Info**

**Where Am I Now?**

**12:00**

**MI**

**MAP**

Program or save trips with multiple destinations

Route to your Home destination

Search Points of Interest near the current vehicle position

View the map

Route to a nearby emergency facility

# ELECTRONICS

## **Finding Points Of Interest**

- From the NAV main menu, touch the “Points of Interest” soft-key.
- Select a Category and then a subcategory, if necessary.
- Select your destination and touch “GO.”

## **Finding A Place By Entering The Street Address**

- From the NAV main menu, touch “New Destination,” then touch “Street Address.”

**NOTE:** If the wrong State and/or Country displayed are incorrect, touch the corresponding soft-key to make the correction.

- Once the Country and State are set and the Street Address screen is displayed, begin spelling the street name in the speller. In the upper right corner the number of possible roads decreases.
- Touch the “LIST” soft-key to display a list of possible street names. Select the correct street name.
- Next input the number
- In the Confirm Route screen the navigation radio displays the complete address, a map of the destination area, and the current routing method for you to verify.
- Touch the “GO” soft-key to activate the route guidance.

## **Where Am I Now?**

- From the NAV main menu, touch “Where Am I Now?.” The Where Am I Now? menu displays location information for the current vehicle position.
- Touch the “NEARBY POI” soft-key to search for a local Point of Interest.
- Touch the “SAVE LOCATION” soft-key to save the current location in the Saved Locations memory.

# ELECTRONICS

## Route Guidance

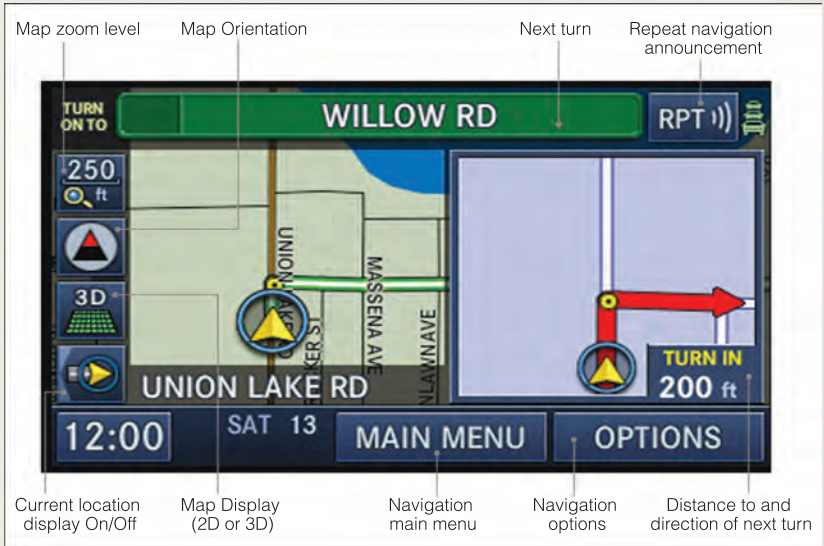

- After starting route guidance, the system calculates the route and announces: “Follow the arrows on the display.” You will receive navigation recommendations by voice messages and screen displays.

## Route Options

- After pressing the “OPTIONS” soft-key in the Route Guidance Menu, the following information is displayed:
  - In the left half of the screen, the current position and the current routing method are displayed.
  - “Take Detour” will allow you to calculate a different route.
  - Touch “Find Nearby POI” to search for a local POI.
  - “Destination Info” displays destination information.
  - “View Turn List” lists streets utilized for the current route.
  - Touch the “Save Destination” to save the destination address.
  - “Change Method” will allow you to change the routing method.

## Entering Your Home Location

- Press the “NAV” hard-key on the right side of the radio.
- From the Nav - Main Menu, touch Guide Me Home to enter your home address. If no home address has been set, touch “YES” to access the Enter Home Address menu.

# ELECTRONICS

- Touch “Street Address” to enter your address. Touch the soft-key with your state’s name and enter your street name into the speller.
- Once the street name has been input, touch “CONTINUE” to confirm. Enter the house number into the next screen. If more than one city has this address, you will then need to select your city from a list.
- Once the address is entered completely, the system shows a map of your home address area. Touch “SAVE” to confirm the address. The system will then ask if you want to go there, yes or no.

## **Change Home Address**

- This procedure will allow you to change your Home Address if one has already been entered.
  - Press the “MENU” hard-key, touch “My Files” and then touch “My Address Book.”
  - Touch “Home,” then touch “Edit Contacts” and then “Change Address.”
  - Touch the soft-key with your state’s name and enter your street name into the speller.
  - Once the street name has been input, touch “CONTINUE” to confirm.
  - Enter the house number into the next screen. If more than one city has this address, you will then need to select your city from a list.
  - Touch the “SAVE” soft-key to confirm the address.

## **Go Home**

- From the NAV main menu, touch “Guide Me Home” when you want to route to your home destination.

## **SIRIUS TRAVEL LINK (Media Center 730N (RHR) & Media Center 430N (RHB) Only)**

- SIRIUS Travel Link brings a wealth of useful information into your vehicle and right to your fingertips.
- To access Travel Link, press the MENU hard-key, then the Travel Link soft-key

**NOTE:** SIRIUS Travel Link requires a subscription, sold separately after the 1 year trial subscription included with your vehicle purchase.

# ELECTRONICS



<b>1 - Favorites</b>	View and store your favorite location, theater and sport teams for quick access.
<b>2 - Forecast</b>	View detailed weather conditions, forecasts and ski/snowboarding conditions at local resorts.
<b>3 - Ski Info</b>	View ski and snowboarding conditions at local ski resorts.
<b>4 - Fuel Prices</b>	View detailed price information for fuel stations near your current location.
<b>5 - Movies</b>	View information on movies that are playing at theaters near your current location.
<b>6 - Sports</b>	View sports scores and upcoming events for all major sports.

## STEERING WHEEL AUDIO CONTROLS



- The steering wheel audio controls are located on the rear surface of the steering wheel.

### Right Switch

- Press the switch up or down to increase or decrease the volume.
- Press the button in the center to change modes AM/FM/CD/SAT.

### Left Switch

- Press the switch up or down to search for the next listenable station or select the next or previous CD track.

- Press the button in the center to select the next preset station (radio) or to change CDs if equipped with a CD Changer.

# ELECTRONICS

## iPod®/USB/MP3 CONTROL

- There are many ways to play music from iPod®/MP3 players or USB devices through your vehicle's sound system.
- The remote USB port, located within the center console, allows you to plug an iPod® into the vehicle's sound system.

**NOTE:** If equipped with the Media Center 730N (RHR), the USB port on the faceplate allows the same functions as the remote USB port.

- Non-Touch-Screen Radios: To hear audio from devices connected to the USB port, press the "AUX" button on the radio faceplate
- Touch-Screen Radios: To hear audio from devices connected to the USB port, press the "MEDIA" hard-key, then touch the "AUX" or "iPod®" soft-key.



- When connected to this feature:
  - The iPod® can be controlled using the radio buttons to Play, Browse, and List the iPod® or external devices contents.
  - The iPod® battery charges when plugged into the USB port (if supported by the specific audio device).

- Compatible iPod® devices may also be controllable using voice commands. Refer to the Owner's Manual on the DVD for details.

### NOTE:

- The USB port supports certain Mini, Classic, Nano, Touch, and iPhone® devices. The USB port also supports playing music from compatible external USB Mass Storage Class memory devices. For supported audio file formats, refer to the USB Port section in the Owner's Manual on the DVD. Refer to <https://www.jeep.com/uconnect/> website for a list of tested iPod®s. Some iPod® software versions may not fully support the USB port features. Please visit Apple's website for iPod® software updates.

## WARNING!

Do not plug in or remove the iPod® or external device while driving. Failure to follow this warning could result in a collision.

## Uconnect™ Phone

- To determine if your vehicle is equipped with Uconnect™ Phone, press the "Uconnect™ Phone" button . If your vehicle has this feature, after a couple seconds you will hear a voice prompt. If not, you will see a message on the radio "Uconnect phone not available".

# ELECTRONICS

- The Uconnect™ Phone is a voice-activated, hands-free, in-vehicle communications system with Voice Command Capability (see Voice Command section).

**NOTE:** To access the tutorial, press the “Uconnect™ Phone” button . After the BEEP, say “tutorial”. Press any hard-key/button or touch the display (Touch-Screen radio) to cancel the tutorial.

- The Uconnect™ Phone allows you to dial a phone number with your mobile phone using simple voice commands.
- Refer to your vehicle Owner’s Manual on the DVD for further details.

**NOTE:** The Uconnect™ Phone requires a mobile phone equipped with the Bluetooth® Hands-Free Profile, Version 1.0 or higher. For Uconnect™ customer support, call 1-877-855-8400 or visit [www.jeep.com/uconnect](http://www.jeep.com/uconnect).

## Phone Pairing

**NOTE:** Pairing is a one-time initial setup before using the phone.

- Press the “Phone” button  to begin.
- Wait for the “ready” prompt and BEEP.
- (After the BEEP), say “setup” or “Uconnect device setup”.
- (After the BEEP), say “device pairing”.
- (After the BEEP), say “pair a device”.
- Follow the audible prompts.



- You will be asked to say a four-digit Personal Identification Number (PIN), which you will later need to enter into your mobile phone. You can say any four-digit PIN. You will not need to remember this PIN after the initial pairing process.
- You will then be prompted to give the phone pairing a name (each phone paired should have a unique name).
- Next you will be asked to give this new pairing a priority of 1 thru 7 (up to seven phones may be paired); 1 is the highest and 7 is the lowest priority. The system will only connect to the highest priority phone that exists within the proximity of the vehicle.
- You will then need to start the pairing procedure on your cell phone. Follow the Bluetooth® instructions in your cell phone Owner’s Manual to complete the phone pairing setup.

# ELECTRONICS

## Phonebook

### Phonebook Download - Automatic Phonebook Transfer From Mobile Phone



If equipped and specifically supported by your phone, Uconnect™ Phone automatically downloads names (text names) and number entries from your mobile phone's phonebook. Specific Bluetooth® Phones with Phone Book Access Profile may support this feature. Automatic Transfer is indicated by a green arrow at the bottom of the screen. See Uconnect™ website for supported phones.

- Automatic download and update, if supported, begins as soon as the Bluetooth® wireless phone connection is made to the Uconnect™ Phone, for example, after you start the vehicle.
- A maximum of 1000 entries per phone will be downloaded and updated every time a phone is connected to the Uconnect™ Phone.
- Depending on the maximum number of entries downloaded, there may be a short delay before the latest downloaded names can be used. Until then, if available, the previously downloaded phonebook is available for use.
- Only the phonebook of the currently connected mobile phone is accessible.
- Only the mobile phone's phonebook is downloaded. SIM card phonebook is not part of the Mobile phonebook.
- This downloaded phonebook cannot be edited or deleted on the Uconnect™ Phone. These can only be edited on the mobile phone. The changes are transferred and updated to Uconnect™ Phone on the next phone connection.

### Phonebook Edit

- Press the "Phone" button .
- (After the BEEP), say "phonebook".
- (After the BEEP), say "new entry" or "list names" or "delete".
- Follow the prompts.

### Making A Phone Call

- Press the "Phone" button .
- (After the BEEP), say "dial" (or "call" a name).
- (After the BEEP), say number (or name).

### Receiving A Call - Accept (And End)

- When an incoming call rings/is announced on Uconnect™, press the Phone button .



# ELECTRONICS

- To end a call, press the Phone button .

## Mute (Or Unmute) Microphone During Call

- During a call, press the “Voice Command” button  VR .
- (After the BEEP), say “mute” (or “mute off”).

## Transfer Ongoing Call Between Handset And Vehicle

- During a call, press the “Voice Command” button  VR .
- (After the BEEP), say “transfer call”.



## Changing The Volume

- Start a dialogue by pressing the “Phone” button , then adjust the volume during a normal call.
- Use the radio ON/OFF VOLUME rotary knob to adjust the volume to a comfortable level while the Uconnect™ system is speaking. Please note the volume setting for Uconnect™ is different than the audio system.

### WARNING!

- Any voice commanded system should be used only in safe driving conditions following local laws and phone use. All attention should be kept on the roadway ahead. Failure to do so may result in a collision causing you and others to be severely injured or killed.
- In an emergency, to use Uconnect™ Phone, your mobile phone must be:
  - turned on,
  - paired to Uconnect™ Phone,
  - and have network coverage.

## Uconnect™ VOICE COMMAND

- The Uconnect™ Voice Command system allows you to control your AM, FM radio, satellite radio, disc player, HDD, Uconnect™ Phone, a memo recorder, and supported portable media devices.
- When you press the “Voice Command” button  VR located on the radio faceplate or steering wheel, you will hear a beep. The beep is your signal to give a command. If you do not say a command within a few seconds, the system will present you with a list of options. If you ever wish to interrupt the system while it lists options, press the “Voice Command” button  VR , listen for the BEEP, and say your command.

# ELECTRONICS

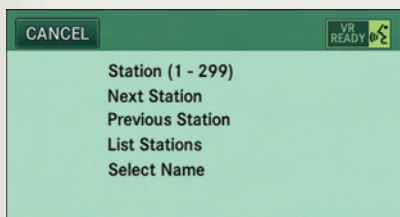

## Voice Command Operation



- Start a dialogue by pressing the “Voice Command” button (VR), you will hear a beep. The beep is your signal to give a command. Below are a list of voice commands for each of the different modes.

## Common Voice Commands

### (Examples)

Main Menu	“Radio” (to switch to the radio mode) “Disc” (to switch to the disc mode) “Memo” (to switch to the memo recorder) “System Setup” (to switch to system setup)
Radio Mode	“Frequency” (to change the frequency) “Next Station” (to select the next station) “Previous Station” (to select the previous station) “Radio Menu” (to switch to the radio menu) “Main Menu” (to switch to the main menu)
SIRIUS Satellite Radio Mode	“Channel Number” (to change the channel by its spoken number) “Next Channel” (to select the next channel) “Previous Channel” (to select the previous channel) “List Channel” (to hear a list of available channels) “Select Name” (to say the name of a channel) “Radio Menu” (to switch to the radio menu) “Main Menu” (to switch to the main menu)
Disc Mode	“Track” (#) (to change the track) “Next Track” (to play the next track) “Previous Track” (to play the previous track) “Main Menu” (to switch to the main menu)

# ELECTRONICS

Memo Mode	<p>To switch to the voice recorder mode, say “Memo”. The following are common voice commands for this mode:</p> <p>“New Memo” (to record a new memo) — During the recording, you may press the Voice Command button  VR to stop recording. You proceed by saying one of the following commands:</p> <ul style="list-style-type: none"><li>— “Save” (to save the memo)</li><li>— “Continue” (to continue recording)</li><li>— “Delete” (to delete the recording)</li><li>— “Play Memos” (to play previously recorded memos) — During the playback you may press the Voice Command button  VR to stop playing memos. You proceed by saying one of the following commands:</li></ul> <ul style="list-style-type: none"><li>— “Repeat” (to repeat a memo)</li><li>— “Next” (to play the next memo)</li><li>— “Previous” (to play the previous memo)</li><li>— “Delete” (to delete a memo)</li><li>— “Delete All” (to delete all memos)</li></ul>
-----------	--

## Voice Command for Text Messaging

- If equipped with Uconnect™ Voice Command, your Media Center 430N & 730N radios may be able to play incoming Short Message Service (SMS) messages (text messages) through the vehicle’s sound system.
- It also allows you to respond by selecting from various pre-defined phrases.
- Not all phones are compatible with this feature. Refer to the phone compatibility list at [www.jeep.com/uconnect](http://www.jeep.com/uconnect). Connected mobile phones must be bluetooth-compatible, and paired with your radio.
- Press the “Voice Command” button  VR and after the BEEP, say “SMS” to get started.

**NOTE:** To access the tutorial, press the “Voice Command” button  VR . After the BEEP, say “tutorial”. Press any hard-key/button or touch the display (Touch-Screen radio) to cancel the tutorial.

## WARNING!

Any voice commanded system should be used only in safe driving conditions following local laws and phone use. All attention should be kept on the roadway ahead. Failure to do so may result in a collision causing you and others to be severely injured or killed.

# ELECTRONICS

## Bluetooth® STREAMING AUDIO



- If equipped with Uconnect™ Voice Command, your Bluetooth-equipped iPod® devices, cell phones or other media players, may also be able to stream music to your vehicle's speakers. Your connected device must be Bluetooth-compatible, and paired with your Media Center radio (see Uconnect™ Phone for pairing

instructions). Non-Touch-Screen Radios: Press the "AUX" button on the radio faceplate until "BT" or "Audio Streaming" is displayed on the radio screen. Touch-Screen-Radios: Press the "RADIO/MEDIA" or "MEDIA" hard-key and then touch the "AUX" soft-key tab.

## ELECTRONIC VEHICLE INFORMATION CENTER (EVIC)

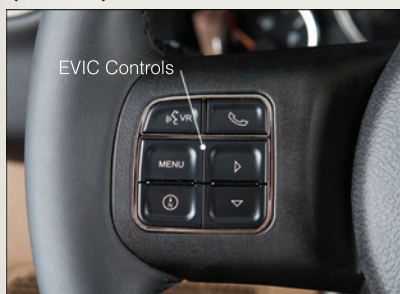

- The EVIC features a driver interactive display that is located in the instrument cluster. Pressing the controls on the steering wheel allows the driver to select vehicle information and Personal Settings. For additional information, refer to Programmable Features in this guide.
- Press and release the MENU button to scroll through the main menus (Fuel Economy, Warnings,

Timer, Units, System, Personal Settings) or to exit sub menus.

- Press and release the SELECT ► button for access to main menus, sub menus or to select a personal setting in the setup menu.
- Press and release the COMPASS Ⓢ button to display one of eight compass readings and the outside temperature or to exit sub menus.
- Press and release the DOWN ▼ button to scroll downward through the sub menus.

### Compass Calibration

- This compass is self-calibrating, which eliminates the need to set the compass manually. When the vehicle is new, the compass may appear erratic and the EVIC will display "CAL" until the compass is calibrated.
- You may also calibrate the compass by completing one or more 360 degree turns (in an area free from large metal or metallic objects) until the "CAL" message displayed in the EVIC turns off. The compass will now function normally.



# ELECTRONICS

## ECO

- The ECO message will appear in your EVIC display whenever you are driving in a fuel efficient manner.
- This feature allows you to monitor when you are driving in a fuel efficient manner, and it can be used to modify driving habits in order to increase fuel economy.

## PROGRAMMABLE FEATURES

### Electronic Vehicle Information Center (EVIC) - If Equipped

- The EVIC can be used to program the following Personal Settings. Press and release the MENU button  until Personal Settings displays, then press the DOWN button  to scroll through the settings. Press the SELECT button  to change the setting.
  - Language
  - Nav - Turn by Turn
  - Auto UNLK On Exit
  - RKE Unlock
  - Sound Horn With RKE Lock
  - Flash Lamp With Lock
  - Headlamp Off Delay
  - Headlamps With Wipers
  - Key-Off Power Delay
  - Illumin Approach
  - Display Units of Measure In
  - Hill Start Assist (HSA) — If Equipped
  - Display Fuel Saver — If Equipped

### Key Fob Programmable Features

- The following features may also be programmed by using the Key Fob transmitter or the ignition switch and driver's door lock switch.

**NOTE:** Pressing the LOCK button while you are inside the vehicle will activate the Vehicle Security Alarm. Opening a door with the Vehicle Security Alarm activated will cause the alarm to sound. Press the UNLOCK button to deactivate the Vehicle Security Alarm.

### Flashing Lamps With Lock

- The turn signal lights flashing, when the doors are locked or unlocked, feature can be turned on or off. To turn this feature on or off:
  - Press and hold the UNLOCK button for at least 4 seconds, but no longer than 10 seconds. Then, press and hold the LOCK button while still holding the UNLOCK button.
  - Release both buttons at the same time.

# ELECTRONICS

## POWER INVERTER



- A 115 Volt, 150 Watt AC power inverter is located on the front of the center console.
- This outlet can power cellular phones, electronics and other low power devices requiring power up to 150 Watts.

- The power inverter switch is located on the instrument panel below the climate controls. To turn on the power outlet, press the switch once. The indicator light will illuminate. Press the switch a second time to turn the power inverter outlet off.

**NOTE:** The power inverter is designed with built-in overload protection. If the power rating of 150 Watts is exceeded, the power inverter will automatically shut down. Once the electrical device has been removed from the outlet, the inverter should automatically reset. If the power rating exceeds approximately 170 Watts, the power inverter may have to be reset manually. To reset the inverter manually, unplug the device and plug it in again. To avoid overloading the circuit, check the power ratings on electrical devices prior to using the inverter.

### WARNING!

To avoid being severely injured or killed: Do not use a three-prong adaptor. Do not insert any objects into the receptacles. Do not touch with wet hands. Close the lid when not in use. If this outlet is mishandled, it may cause an electric shock and failure.

## POWER OUTLETS

- There are three possible 12-Volt Power Outlets in this vehicle.
- The front power outlet, located in the lower portion of the instrument panel, is powered when the key is in the ON or ACC position.
- A second power outlet is located inside the center console bin and is powered directly from the vehicle battery.
- On vehicles equipped with a rear subwoofer, there is a power outlet located in the right rear cargo area.

### NOTE:

- Do not exceed the maximum power of 160 Watts (13 Amps) at 12 Volts. If the 160 Watt (13 Amp) power rating is exceeded the fuse protecting the system will need to be replaced.

# ELECTRONICS

- Power outlets are designed for accessory plugs only. Do not insert any other object in the power outlet as this will damage the outlet and blow the fuse. Improper use of the power outlet can cause damage not covered by your new vehicle warranty.

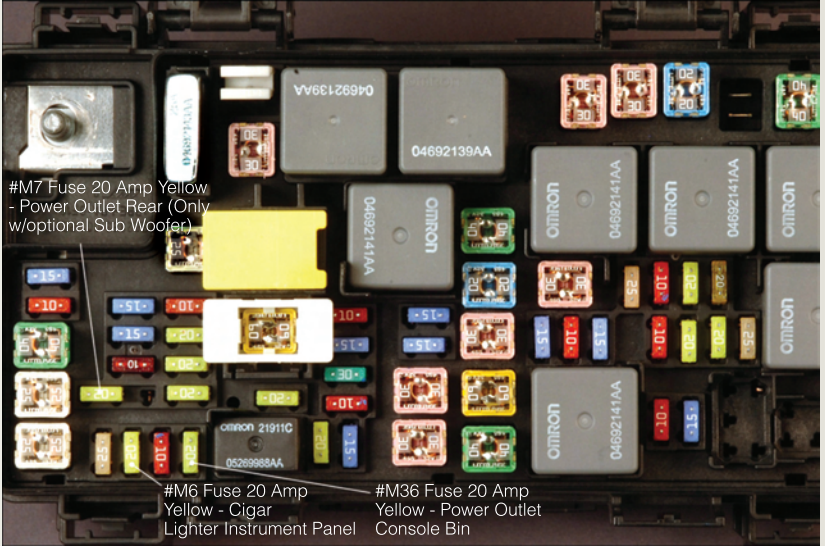

# OFF-ROAD CAPABILITIES

## COMMAND-TRAC®/ ROCK-TRAC®

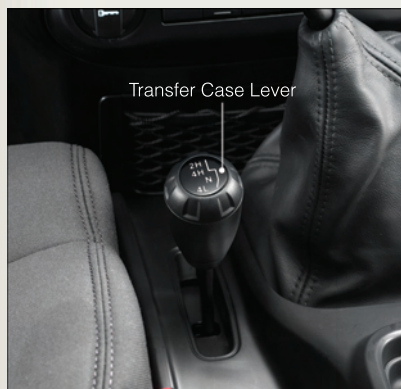

- The transfer case provides four mode positions: 2H (Two-wheel drive high range), 4H (Four-wheel drive high range), N (Neutral), and 4L (Four-wheel drive low range).
- The transfer case is intended to be driven in the 2H position for normal street and highway conditions such as hard-surfaced roads.
- Shifting between 2H and 4H can be made with the vehicle stopped or in motion. Shift the transfer case lever firmly to 4H at any speed up to 50 mph (80 km/h).

- Shifting between 4H and 4L can be made with the vehicle rolling at 2 to 3 mph (3 to 5 km/h). Shift the automatic transmission into NEUTRAL or fully depress the clutch pedal on a manual transmission. Shift the transfer case lever firmly to 4L (do not pause with the transfer case in NEUTRAL). Once the shift is completed, place the automatic transmission into DRIVE or release the clutch pedal on a manual transmission.

**NOTE:** To enhance off-road performance in 4L mode, manual transmission vehicles will start regardless of whether or not the clutch pedal is depressed.

## AXLE LOCK (TRU-LOK®) RUBICON ONLY

- The AXLE LOCK switch is located on the instrument panel (to the left of the steering column).
- This feature will only activate when the following conditions are met:
  - Key in ignition, vehicle in 4L (Low) range.
  - Vehicle speed at 10 mph (16 km/h) or less.
- Press the bottom of the AXLE LOCK switch once to lock the rear axle only and a second time to lock the front axle (the rear and front axle lock indicator lights will illuminate).
- To unlock the axles, press the top of the AXLE LOCK switch.
- The indicator light will flash until the axles are fully locked or unlocked.



# OFF-ROAD CAPABILITIES

## **ELECTRONIC SWAY BAR DISCONNECT - RUBICON ONLY**

### **Off-Road**

- Press the SWAY BAR switch, located on the instrument panel (to the left of the steering column), once to disconnect the Sway Bar.
- The Sway Bar indicator light will illuminate in the instrument cluster.

### **On-Road**

- Press the SWAY BAR switch a second time to reconnect the Sway Bar.
- The Sway Bar should remain in on-road mode during normal driving conditions.

# UTILITY

## TRAILER TOWING WEIGHTS (MAXIMUM TRAILER WEIGHT RATINGS)

Engine/ Transmission	Axle	Model	GCWR (Gross Combined Wt. Rating)	Frontal Area	Max. GTW (Gross Trailer Wt.)	Max. Trailer Tongue Wt. (See Note)
3.8L/Manual	3.21	Two-Door Sport Model (4WD)	5,329 lbs (2,417 kg)	25 sq ft (2.32 sq m)	1,000 lbs (453 kg)	100 lbs (45 kg)
3.8L/Manual	3.73	Two-Door Sport Model (4WD)	6,329 lbs (2,871 kg)	25 sq ft (2.32 sq m)	2,000 lbs (907 kg)	200 lbs (91 kg)
3.8L/ Automatic	3.73	Two-Door Sport Model (4WD)	6,353 lbs (2,881 kg)	25 sq ft (2.32 sq m)	2,000 lbs (907 kg)	200 lbs (91 kg)
3.8L/Manual	3.21	Two-Door Sahara Model (4WD)	5,430 lbs (2,463 kg)	25 sq ft (2.32 sq m)	1,000 lbs (453 kg)	100 lbs (45 kg)
3.8L/Manual	3.73	Two-Door Sahara Model (4WD)	6,430 lbs (2,916 kg)	25 sq ft (2.32 sq m)	2,000 lbs (907 kg)	200 lbs (91 kg)
3.8L/ Automatic	3.73	Two-Door Sahara Model (4WD)	6,454 lbs (2,927 kg)	25 sq ft (2.32 sq m)	2,000 lbs (907 kg)	200 lbs (91 kg)
3.8L/Manual	4.10	2-Door Rubicon Model (4WD)	6,507 lbs (2,951 kg)	25 sq ft (2.32 sq m)	2,000 lbs (907 kg)	200 lbs (91 kg)
3.8L/ Automatic	4.10	Two-Door Rubicon Model (4WD)	6,533 lbs (2,963 kg)	25 sq ft (2.32 sq m)	2,000 lbs (907 kg)	200 lbs (91 kg)
3.8L/Manual	3.21	Four-Door Sport Model (4WD)	5,742 lbs (2,604 kg)	32 sq ft (2.97 sq m)	1,000 lbs (453 kg)	100 lbs (45 kg)
3.8L/Manual	3.73	Four-Door SportModel (4WD)	8,242 lbs (3,738 kg)	32 sq ft (2.97 sq m)	3,500 lbs (1,587 kg)	350 lbs (159 kg)
3.8L/ Automatic	3.73	Four-Door Sport Model (4WD)	8,257 lbs (3,745 kg)	32 sq ft (2.97 sq m)	3,500 lbs (1,587 kg)	350 lbs (159 kg)
3.8L/Manual	3.21	Four-Door Sahara Model (4WD)	5,782 lbs (2,623 kg)	32 sq ft (2.97 sq m)	1,000 lbs (453 kg)	100 lbs (45 kg)

Engine/ Transmission	Axle	Model	GCWR (Gross Combined Wt. Rating)	Frontal Area	Max. GTW (Gross Trailer Wt.)	Max. Trailer Tongue Wt. (See Note)
3.8L/Manual	3.73	Four-Door Sahara Model (4WD)	8,282 lbs (3 757 kg)	32 sq ft (2.97 sq m)	3,500 lbs (1 587 kg)	350 lbs (159 kg)
3.8L/ Automatic	3.73	Four-Door Sahara Model (4WD)	8,297 lbs (3 763 kg)	32 sq ft (2.97 sq m)	3,500 lbs (1 587 kg)	350 lbs (159 kg)
3.8L/Manual	4.10	Four-Door Rubicon Model (4WD)	8,406 lbs (3 813 kg)	32 sq ft (2.97 sq m)	3,500 lbs (1 587 kg)	350 lbs (159 kg)
3.8L/ Automatic	4.10	Four-Door Rubicon Model (4WD)	8,431 lbs (3 824 kg)	32 sq ft (2.97 sq m)	3,500 lbs (1 587 kg)	350 lbs (159 kg)

Refer to local laws for maximum trailer towing speeds.

**NOTE: The trailer tongue weight must be considered as part of the combined weight of occupants and cargo (ie. the GVWR), and the GVWR should never exceed the weight referenced on the Tire and Loading Information placard.**

# UTILITY

## RECREATIONAL TOWING (BEHIND MOTORHOME, ETC.)

### Towing This Vehicle Behind Another Vehicle

Towing Condition	Wheels OFF the Ground	Four-Wheel Drive Models
Flat Tow	NONE	<b>See Instructions</b> <ul style="list-style-type: none"><li>• Automatic transmission in PARK</li><li>• Manual transmission in gear (NOT in NEUTRAL (N))</li><li>• Transfer case in NEUTRAL (N)</li><li>• Tow in forward direction</li></ul>
Dolly Tow	Front	<b>NOT ALLOWED</b>
	Rear	<b>NOT ALLOWED</b>
On Trailer	ALL	OK

### Recreational Towing - Four-Wheel Drive Models

**NOTE:** The transfer case must be shifted into **NEUTRAL (N)**, automatic transmission must be shifted into **PARK**, and manual transmission must be placed in gear (NOT in NEUTRAL) for recreational towing.

#### Shifting Into NEUTRAL (N)

Use the following procedure to prepare your vehicle for recreational towing.

1. Bring the vehicle to a complete stop.
2. Turn OFF the engine.
3. Press and hold the brake pedal.
4. Shift the automatic transmission into NEUTRAL or depress the clutch pedal on a manual transmission.
5. Shift the transfer case lever into NEUTRAL (N).
6. Start the engine.

7. Shift the transmission into REVERSE.
8. Release the brake pedal (and clutch pedal on manual transmissions) for five seconds and ensure that there is no vehicle movement.
9. Repeat steps 7 and 8 with automatic transmission in DRIVE or manual transmission in first gear.
10. Turn OFF the engine and leave the ignition switch in the unlocked ACC position.
11. Firmly apply the parking brake.
12. Shift the transmission into PARK or place manual transmission in gear (NOT in Neutral).
13. Attach the vehicle to the tow vehicle using a suitable tow bar.
14. Release the parking brake.

15. Disconnect the negative battery cable, and secure it away from the negative battery post.

## Shifting Out of NEUTRAL (N)

Use the following procedure to prepare your vehicle for normal usage.

1. Bring the vehicle to a complete stop, leaving it connected to the tow vehicle.
2. Firmly apply the parking brake.
3. Reconnect the negative battery cable.
4. Turn the ignition switch to the LOCK/OFF position.
5. Turn the ignition switch to the ON/RUN position, but do not start the engine.
6. Press and hold the brake pedal.
7. Shift the transmission into NEUTRAL.
8. Shift the transfer case lever to the desired position.

**NOTE:** When shifting out of transfer case NEUTRAL (N), turning the engine OFF may be required to avoid gear clash.

9. Shift the automatic transmission into PARK, or place manual transmission in Neutral.
10. Release the brake pedal.
11. Disconnect vehicle from the tow vehicle.
12. Start the engine.
13. Press and hold the brake pedal.
14. Release the parking brake.
15. Shift the transmission into gear, release the brake pedal (and clutch pedal on manual transmissions), and check that the vehicle operates normally.

## CAUTION!

- It is necessary to follow these steps to be certain that the transfer case is fully in NEUTRAL (N) before recreational towing to prevent damage to internal parts.
- Damage to the transmission may occur if the transmission is shifted into PARK with the transfer case in NEUTRAL (N) and the engine running. With the transfer case in NEUTRAL (N) ensure that the engine is OFF prior to shifting the transmission into PARK.
- Front or rear wheel lifts should not be used. Internal damage to the transmission or transfer case will occur if a front or rear wheel lift is used when recreational towing.
- Tow only in the forward direction. Towing this vehicle backwards can cause severe damage to the transfer case.
- Automatic transmissions must be placed in the PARK position for recreational towing.
- Manual transmissions must be placed in gear (not in Neutral) for recreational towing.
- Before recreational towing, perform the procedure outlined under "Shifting Into NEUTRAL (N)" to be certain that the transfer case is fully in NEUTRAL (N). Otherwise, internal damage will result.

**(Continued)**

# UTILITY

## **CAUTION!** *(Continued)*

- Towing this vehicle in violation of the above requirements can cause severe transmission and/or transfer case damage. Damage from improper towing is not covered under the New Vehicle Limited Warranty.
- Do not use a bumper-mounted clamp-on tow bar on your vehicle. The bumper face bar will be damaged.

## **WARNING!**

- You or others could be injured if you leave the vehicle unattended with the transfer case in the NEUTRAL (N) position without first fully engaging the parking brake. The transfer case NEUTRAL (N) position disengages both the front and rear driveshafts from the powertrain and will allow the vehicle to move, even if the transmission is in PARK. The parking brake should always be applied when the driver is not in the vehicle.

# WHAT TO DO IN EMERGENCIES

## 24-HOUR TOWING ASSISTANCE

- Dial toll-free 1-800-521-2779 or 1-800-363-4869 for Canadian residents.
- Provide your name, vehicle identification number and license plate number.
- Provide your location, including telephone number, from which you are calling.
- Briefly describe the nature of the problem and answer a few simple questions.
- You will be given the name of the service provider and an estimated time of arrival. If you feel you are in an “unsafe situation”, please let us know. With your consent, we will contact local police or safety authorities.

## INSTRUMENT CLUSTER WARNING LIGHTS

### - Electronic Stability Control (ESC) Activation/Malfunction Indicator Light

- If the “ESC Activation/Malfunction Indicator Light” comes on continuously with the engine running, a malfunction has been detected in the ESC system. If this light remains on after several ignition cycles, and the vehicle has been driven several miles (kilometers) at speeds greater than 30 mph (48 km/h), we recommend you drive to the nearest service center and have the vehicle serviced immediately.
- The “ESC Activation/Malfunction Indicator Light” starts to flash as soon as the tires lose traction and the ESC system becomes active. If the light begins to flash during acceleration, ease up on the accelerator and apply as little throttle as possible. Be sure to adapt your speed and driving to the prevailing road conditions. The light also flashes when TCS is active. To improve the vehicle’s traction when starting off in deep snow, sand or gravel, it may be desirable to switch the ESC system to Partial Off mode by momentarily pressing the ESC Off  switch.

### - Tire Pressure Monitoring System (TPMS) Light

- Each tire, including the spare (if provided), should be checked monthly, when cold and inflated to the inflation pressure recommended by the vehicle manufacturer on the vehicle placard or tire inflation pressure label. (If your vehicle has tires of a different size than the size indicated on the vehicle placard or tire inflation pressure label, you should determine the proper tire inflation pressure for those tires.)
- As an added safety feature, your vehicle has been equipped with a Tire Pressure Monitoring System (TPMS) that illuminates a low tire pressure telltale when one or more of your tires is significantly under-inflated. Accordingly, when the low tire pressure telltale illuminates, you should stop and check your tires as soon as possible, and inflate them to the proper pressure. Driving on a significantly under-inflated tire causes the tire to overheat and can lead to tire failure. Under-inflation also reduces fuel efficiency and tire tread life, and may affect the vehicle’s handling and stopping ability.

# WHAT TO DO IN EMERGENCIES

- **IF THE LIGHT STARTS FLASHING INDICATING A LOW TIRE PRESSURE, ADJUST THE AIR PRESSURE IN THE LOW TIRE TO THE AIR PRESSURE SHOWN ON THE VEHICLE PLACARD OR TIRE INFLATION PRESSURE LABEL LOCATED ON THE DRIVER'S DOOR. NOTE: AFTER INFLATION, THE VEHICLE MAY NEED TO BE DRIVEN FOR 20 MINUTES BEFORE THE FLASHING LIGHT WILL TURN OFF.**
- Please note that the TPMS is not a substitute for proper tire maintenance, and it is the driver's responsibility to maintain correct tire pressure, even if under-inflation has not reached the level to trigger illumination of the TPMS low tire pressure telltale.
- Your vehicle has also been equipped with a TPMS malfunction indicator to indicate when the system is not operating properly. The TPMS malfunction indicator is combined with the low tire pressure telltale. When the system detects a malfunction, the telltale will flash for approximately one minute and then remain continuously illuminated. This sequence will continue each time the vehicle is restarted as long as the malfunction exists.
- When the malfunction indicator is illuminated, the system may not be able to detect or signal low tire pressure as intended. TPMS malfunctions may occur for a variety of reasons, including the installation of replacement or alternate tires or wheels on the vehicle that prevent the TPMS from functioning properly. Always check the TPMS malfunction telltale after replacing one or more tires or wheels on your vehicle, to ensure that the replacement or alternate tires and wheels allow the TPMS to continue to function properly.

**NOTE:** Tire pressures change by approximately 1 psi (7 kPa) per 12° F (7° C) of air temperature change. Keep this in mind when checking tire pressure inside a garage, especially in the Winter. Example: If garage temperature is 68°F (20°C) and the outside temperature is 32°F (0°C), then the cold tire inflation pressure should be increased by 3 psi (21 kPa), which equals 1 psi (7 kPa) for every 12°F (7°C) for this outside temperature condition.

## CAUTION!

The TPMS has been optimized for the original equipment tires and wheels. TPMS pressures and warning have been established for the tire size equipped on your vehicle. Undesirable system operation or sensor damage may result when using replacement equipment that is not of the same size, type, and/or style. Aftermarket wheels can cause sensor damage. Do not use tire sealant from a can, or balance beads if your vehicle is equipped with a TPMS, as damage to the sensors may result.



# WHAT TO DO IN EMERGENCIES

## - Engine Temperature Warning Light

- This light warns of an overheated engine condition.
- If the light turns on and a warning chime sounds while driving, safely pull over and stop the vehicle. If the A/C system is on, turn it off. Also, shift the transmission into NEUTRAL and idle the vehicle. If the temperature reading does not return to normal, turn the engine off immediately.
- We recommend that you do not operate the vehicle or engine damage will occur. Have the vehicle serviced immediately.

### **WARNING!**

A hot engine cooling system is dangerous. You or others could be badly burned by steam or boiling coolant. You may want to call an authorized service center for service if your vehicle overheats.

## **BRAKE** - Brake Warning Light

- The Brake Warning light illuminates when there is either a system malfunction or the parking brake is applied. If the light is on and the parking brake is not applied, it indicates a possible brake hydraulic malfunction, brake booster problem or an Anti-Lock Brake System problem.
- Please have your vehicle serviced immediately.

### **WARNING!**

Driving a vehicle with the red brake light on is dangerous. Part of the brake system may have failed. It will take longer to stop the vehicle. You could have a collision. Have the vehicle checked immediately.

## - Malfunction Indicator Light (MIL)

- Certain conditions, such as a loose or missing gas cap, poor fuel quality, etc., may illuminate the MIL after engine start. The vehicle should be serviced if the light stays on through several typical driving cycles. In most situations, the vehicle will drive normally and not require towing.
- If the MIL flashes when the engine is running, serious conditions may exist that could lead to immediate loss of power or severe catalytic converter damage. We recommend you do not operate the vehicle. Have the vehicle serviced immediately.

## - Electronic Stability Control OFF Warning Light

- If the ESC OFF warning light comes on continuously with the engine running, a malfunction has been detected.
- If this light remains on after several ignition cycles, and the vehicle has been driven several miles (kilometers) at speeds greater than 30 mph (48 km/h), we recommend you drive to the nearest service center and have the vehicle serviced immediately.

# WHAT TO DO IN EMERGENCIES

## - **Charging System Light**

- This light shows the status of the electrical charging system. If the charging system light remains on, it means that the vehicle is experiencing a problem with the charging system.
- We recommend you do not continue driving if the charging system light is on. Have the vehicle serviced immediately.

## - **Oil Pressure Warning Light**

- This light indicates low engine oil pressure. If the light turns on while driving, stop the vehicle and shut off the engine as soon as possible. A chime will sound for four minutes when this light turns on.
- We recommend you do not operate the vehicle or engine damage will occur. Have the vehicle serviced immediately.

## - **Anti-Lock Brake (ABS) Light**

- This light monitors the Anti-Lock Brake System (ABS).
- If the light is not on during starting, stays on, or turns on while driving, we recommend you drive to the nearest service center and have the vehicle serviced immediately.

## - **Electronic Throttle Control (ETC) Light**

- This light informs you of a problem with the Electronic Throttle Control (ETC) system.
- If a problem is detected, the light will come on while the engine is running. Cycle the ignition when the vehicle has completely stopped and the shift lever is placed in the PARK position; the light should turn off.
- If the light remains lit with the engine running, your vehicle will usually be drivable; however, see an authorized service center immediately. If the light is flashing when the engine is running, immediate service is required and you may experience reduced performance, an elevated/rough idle or engine stall and your vehicle may require towing.

## - **Air Bag Warning Light**

- If the light is not on during starting, stays on, or turns on while driving, have the vehicle serviced by an authorized service center immediately.

## **Fuel Cap/Loose Gas Cap Message**

- If a “gas cap” message (shown as gASCAP) appears, tighten the gas cap until a “clicking” sound is heard.
- Press the odometer reset button to turn the message off.
- If the message continues to appear for more than three days after tightening the gas cap, see your authorized service center.

## **Oil Change Indicator Message**

- If an “oil change” message (shown as CHAnGE OIL) appears and a single chime sounds, it is time for your next required oil change.

# WHAT TO DO IN EMERGENCIES

## Resetting The Light After Servicing

- Turn the ignition switch to the ON/RUN position (do not start engine).
- Fully depress the accelerator pedal three times within 10 seconds.
- Turn the ignition switch to the OFF/LOCK position.

## HOTOIL - Transmission Temperature Warning Message

- The HOTOIL cluster message will appear in the odometer accompanied with a chime to indicate that there is excessive transmission fluid temperature that might occur with severe usage such as trailer towing.
- It may also occur when operating the vehicle in a high torque converter slip condition, such as 4-wheel-drive operation (e.g., snow plowing, off-road operation).
- If this HOTOIL message turns on, stop the vehicle and run the engine at idle or faster, with the transmission in NEUTRAL until the message turns off.

### CAUTION!

Continuous driving with the Transmission Temperature HOTOIL Warning message illuminated will eventually cause severe transmission damage and transmission failure.

### WARNING!

Continued operation with the Transmission Temperature HOTOIL Warning message illuminated could cause the fluid to boil over, come into contact with the hot engine or exhaust components causing a fire that may result in personal injury.

## IF YOUR ENGINE OVERHEATS

- In any of the following situations, you can reduce the potential for overheating by taking the appropriate action.
- On the highways — slow down.
- In city traffic — while stopped, place the transmission in NEUTRAL, but do not increase engine idle speed.

**NOTE:** There are steps that you can take to slow down an impending overheat condition:

- If your air conditioner (A/C) is on, turn it off. The A/C system adds heat to the engine cooling system and turning the A/C off can help remove this heat.
- You can also turn the temperature control to maximum heat, the mode control to floor and the blower control to high. This allows the heater core to act as a supplement to the radiator and aids in removing heat from the engine cooling system.

# WHAT TO DO IN EMERGENCIES

## CAUTION!

Driving with a hot cooling system could damage your vehicle. If the temperature gauge reads 240°F (116 °C) or greater pull over and stop the vehicle. Idle the vehicle with the air conditioner turned off until the pointer drops back into the normal range 200–230°F (93–110°C). If the pointer remains at 240°F (116°C) or greater and you hear a chime, turn the engine off immediately and call for service.

## WARNING!

You or others can be badly burned by hot engine coolant (antifreeze) or steam from your radiator. If you see or hear steam coming from under the hood, do not open the hood until the radiator has had time to cool. Never try to open a cooling system pressure cap when the radiator or coolant bottle is hot.

## JACKING AND TIRE CHANGING

### Jack Location

- The jack and lug wrench are located in the rear storage compartment.



### Spare Tire Stowage

- To remove the spare tire from the carrier, remove the tire cover, if equipped, and remove the lug nuts with the lug wrench turning them counterclockwise.

**NOTE:** If you have added aftermarket accessories to the spare tire mounted carrier, it cannot exceed a gross weight of 50 lbs (23 kg) including the weight of the spare tire.

### Preparations For Jacking

1. Park on a firm, level surface. Avoid ice or slippery areas.
2. Turn on the Hazard Warning flasher.
3. Set the parking brake.
4. Shift the automatic transmission into PARK, or a manual transmission into REVERSE.
5. Turn the ignition to LOCK.

# WHAT TO DO IN EMERGENCIES



Block both the front and rear of the wheel diagonally opposite of the jacking position. For example, if changing the right front tire, block the left rear wheel.

**NOTE:** Passengers should not remain in the vehicle when the vehicle is being jacked.

## Jacking Instructions



1. Remove the spare tire, jack and tools from the stored location.
2. Loosen (but do not remove) the wheel lug nuts by turning them to the left one turn while the wheel is still on the ground.
3. Assemble the jack and jacking tools. Connect the jack handle driver to the extension, then to the lug wrench.
4. Operate the jack from the front or the rear of the vehicle. Place the jack under the axle tube, as shown. **Do not raise the vehicle until you are sure the jack is fully engaged.**



Front Jacking Location

# WHAT TO DO IN EMERGENCIES

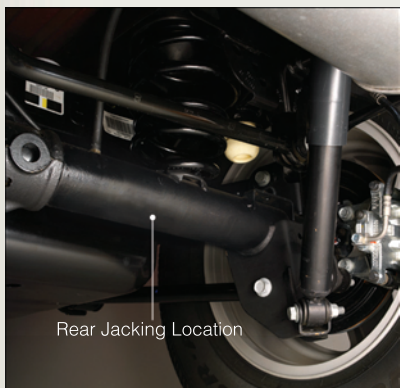

5. Raise the vehicle by turning the jack screw to the right. Raise the vehicle only until the tire just clears the surface and enough clearance is obtained to install the spare tire. Minimum tire lift provides maximum stability.
6. Remove the lug nuts and wheel.
7. Position the spare wheel/tire on the vehicle and install the lug nuts with the cone-shaped end toward the wheel. Lightly tighten the lug nuts clockwise.
8. Lower the vehicle by turning the jack screw to the left, and remove the jack.
9. Finish tightening the lug nuts. Push down on the wrench while tightening for increased leverage. Alternate nuts until each nut has been tightened twice. The correct wheel nut tightness is 95 ft lbs (130 N·m). If in doubt about the correct tightness, have them checked with a torque wrench by your authorized dealer or at a service station.
10. Remove the jack assembly and wheel blocks.
11. Secure the tire, jack, and tools in their proper locations.
12. Remove blocks from wheels.

## Road Tire Installation

1. Mount the road tire on the axle.
2. Install the remaining lug nuts with the cone shaped end of the nut toward the wheel. Lightly tighten the lug nuts.
3. Lower the vehicle to the ground by turning the jack handle counterclockwise.
4. Finish tightening the lug nuts. Push down on the wrench while at the end of the handle for increased leverage. Tighten the lug nuts in a star pattern until each nut has been tightened twice. The correct tightness of each lug nut is 95 ft/lbs (130 N·m). If in doubt about the correct tightness, have them checked with a torque wrench by your authorized dealer or service station.
5. After 25 miles (40 km) check the lug nut torque with a torque wrench to ensure that all lug nuts are properly seated against the wheel.

### CAUTION!

- Do not attempt to raise the vehicle by jacking on locations other than those indicated in the Jacking Instructions for this vehicle.

# WHAT TO DO IN EMERGENCIES

## **WARNING!**

- Do not attempt to change a tire on the side of the vehicle close to moving traffic. Pull far enough off the road to avoid the danger of being hit when operating the jack or changing the wheel.
- Being under a jacked-up vehicle is dangerous. The vehicle could slip off the jack and fall on you. You could be crushed. Never put any part of your body under a vehicle that is on a jack. If you need to get under a raised vehicle, take it to a service center where it can be raised on a lift.
- Never start or run the engine while the vehicle is on a jack.
- The jack is designed to be used as a tool for changing tires only. The jack should not be used to lift the vehicle for service purposes. The vehicle should be jacked on a firm level surface only. Avoid ice or slippery areas.
- Do not attempt to change a tire on the side of the vehicle close to moving traffic, pull far enough off the road to avoid being hit when operating the jack or changing the wheel.
- Carefully follow these tire changing warnings to help prevent personal injury or damage to your vehicle:
- Always park on a firm, level surface as far from the edge of the roadway as possible before raising the vehicle.
- Turn on the Hazard Warning flasher.
- Block the wheel diagonally opposite the wheel to be raised.
- Set the parking brake firmly and set an automatic transmission in PARK; a manual transmission in REVERSE.
- Never start or run the engine with the vehicle on a jack.
- Do not let anyone sit in the vehicle when it is on a jack.
- Do not get under the vehicle when it is on a jack.
- Only use the jack in the positions indicated and for lifting this vehicle during a tire change.
- If working on or near a roadway, be extremely careful of motor traffic.
- To assure that spare tires, flat or inflated, are securely stowed, spares must be stowed with the valve stem facing the ground.
- Raising the vehicle higher than necessary can make the vehicle less stable and cause a collision. It could slip off the jack and hurt someone near it. Raise the vehicle only enough to remove the tire.
- To avoid the risk of forcing the vehicle off the jack, do not tighten the wheel nuts fully until the vehicle has been lowered.
- A loose tire or jack, thrown forward in a collision or hard stop, could endanger the occupants of the vehicle. Always stow the jack parts and the spare tire in the places provided.

*(Continued)*

# WHAT TO DO IN EMERGENCIES

## **WARNING!** *(Continued)*

- To avoid the risk of forcing the vehicle off the jack, do not tighten the lug nuts fully until the vehicle is lowered to the ground.

## **JUMP-STARTING**

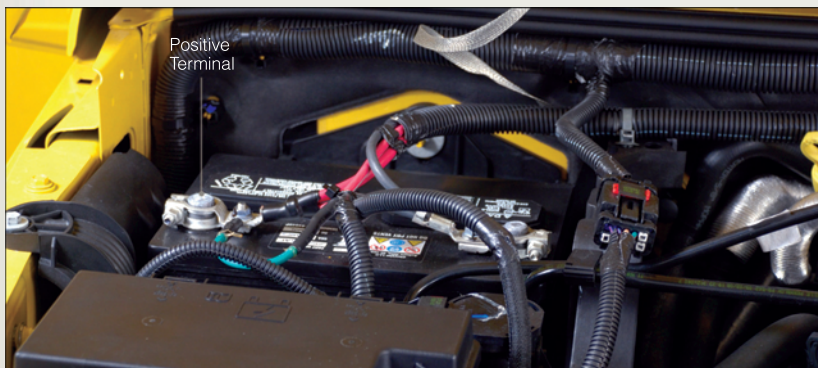

- If your vehicle has a discharged battery it can be jump-started using a set of jumper cables and a battery in another vehicle or by using a portable battery booster pack.
- Jump-starting can be dangerous if done improperly so please follow the procedures in this section carefully.

**NOTE:** When using a portable battery booster pack follow the manufacturer's operating instructions and precautions.

### **Preparations for Jump-Start**

- The battery in your vehicle is located in the right rear of the engine compartment.
- Set the parking brake, shift the automatic transmission into PARK and turn the ignition to LOCK.
- Turn off the heater, radio, and all unnecessary electrical accessories.
- If using another vehicle to jump-start the battery, park the vehicle within the jumper cables reach, set the parking brake and make sure the ignition is OFF.

### **Jump-Starting Procedure**

- Connect the positive (+) end of the jumper cable to the positive (+) post of the discharged vehicle.
- Connect the opposite end of the positive (+) jumper cable to the positive (+) post of the booster battery.
- Connect the negative end (-) of the jumper cable to the negative (-) post of the booster battery.



# WHAT TO DO IN EMERGENCIES

- Connect the opposite end of the negative (-) jumper cable to a good engine ground (exposed metal part of the discharged vehicle's engine) away from the battery and the fuel injection system.
- Start the engine in the vehicle that has the booster battery, let the engine idle a few minutes, and then start the engine in the vehicle with the discharged battery.

Once the engine is started, remove the jumper cables in the reverse sequence:

- Disconnect the negative (-) jumper cable from the engine ground of the vehicle with the discharged battery.
- Disconnect the negative end (-) of the jumper cable from the negative (-) post of the booster battery.
- Disconnect the opposite end of the positive (+) jumper cable from the positive (+) post of the booster battery.
- Disconnect the positive (+) end of the jumper cable from the positive (+) post of the discharged vehicle.
- If frequent jump-starting is required to start your vehicle you should have the battery and charging system inspected at your authorized dealer.

## **CAUTION!**

- Do not use a portable battery booster pack or any other booster source with a system voltage greater than 12 Volts or damage to the battery, starter motor, alternator or electrical system may occur.
- Failure to follow these procedures could result in damage to the charging system of the booster vehicle or the discharged vehicle.
- Accessories that can be plugged into the vehicle power outlets draw power from the vehicle's battery, even when not in use (i.e., cellular phones, etc.). Eventually, if plugged in long enough, the vehicle's battery will discharge sufficiently to degrade battery life and/or prevent the engine from starting.

## **WARNING!**

- When temperatures are below the freezing point, electrolyte in a discharged battery may freeze. Do not attempt jump-starting because the battery could rupture or explode and cause personal injury. Battery temperature must be brought above freezing point before attempting a jump-start.
- Take care to avoid the radiator cooling fan whenever the hood is raised. It can start anytime the ignition switch is on. You can be injured by moving fan blades.

*(Continued)*

# WHAT TO DO IN EMERGENCIES

## **WARNING!** *(Continued)*

- Remove any metal jewelry, such as watch bands or bracelets, that might make an inadvertent electrical contact. You could be severely injured.
- Batteries contain sulfuric acid that can burn your skin or eyes and generate hydrogen gas which is flammable and explosive. Keep open flames or sparks away from the battery.
- Do not allow vehicles to touch each other as this could establish a ground connection and personal injury could result.
- Failure to follow this procedure could result in personal injury or property damage due to battery explosion.
- Do not connect the cable to the negative post (-) of the discharged battery. The resulting electrical spark could cause the battery to explode and could result in personal injury.

## **EMERGENCY TOW HOOKS**

- If your vehicle is equipped with tow hooks, they are mounted in the front and the rear.

**NOTE:** For off-road recovery, it is recommended to use both of the front tow hooks to minimize the risk of damage to the vehicle.

## **CAUTION!**

Tow hooks are for emergency use only, to rescue a vehicle stranded off-road. Do not use tow hooks for tow truck hookup or highway towing. You could damage your vehicle. Tow straps are recommended when towing the vehicle; chains may cause vehicle damage.

## **WARNING!**

- Chains are not recommended for freeing a stuck vehicle. Chains may break, causing serious injury or death.
- Stand clear of vehicles when pulling with tow hooks. Tow straps may become disengaged, causing serious injury.

# WHAT TO DO IN EMERGENCIES

## SHIFT LEVER OVERRIDE



- If a malfunction occurs and the shift lever cannot be moved out of the PARK position, you can use the following procedure to temporarily move the shift lever:
  - To access the shift lever override, remove the override cover located on the PRNDL bezel, next to the shift lever.
  - Firmly set the parking brake.
  - Turn the ignition switch to the ACC or ON position without starting the engine.
  - Press and maintain firm pressure on the brake pedal.

- Using a screwdriver or similar tool, press and hold the override tab through the access port on the center console.
- Move the shift lever into the NEUTRAL position.
- The vehicle may then be started in NEUTRAL.
- Reinstall the override cover.

## TOWING A DISABLED VEHICLE

- The manufacturer requires towing your vehicle with all four wheels **OFF** the ground using a flatbed.

### CAUTION!

Towing this vehicle using any other method could result in extensive damage to the transfer case and/or transmission.

## FREING A STUCK VEHICLE

- If your vehicle becomes stuck in mud, sand or snow, it can often be moved by a rocking motion. Turn your steering wheel right and left to clear the area around the front wheels. Then shift back and forth between DRIVE/1st gear and REVERSE. Using minimal accelerator pedal pressure to maintain the rocking motion, without spinning the wheels, is most effective.

**NOTE:** If your vehicle is equipped with Traction Control or Electronic Stability Control (ESC), turn the system OFF before attempting to “rock” the vehicle.

# WHAT TO DO IN EMERGENCIES

## **CAUTION!**

- Racing the engine or spinning the wheels may lead to transmission overheating and failure. Allow the engine to idle with the shift lever in NEUTRAL for at least one minute after every five rocking-motion cycles. This will minimize overheating and reduce the risk of transmission failure during prolonged efforts to free a stuck vehicle.
- When “rocking” a stuck vehicle by moving between DRIVE/1st gear and REVERSE, do not spin the wheels faster than 15 mph (24 km/h), or drivetrain damage may result.
- Revving the engine or spinning the wheels too fast may lead to transmission overheating and failure. It can also damage the tires. Do not spin the wheels above 30 mph (48 km/h) while in gear (no transmission shifting occurring).

## **WARNING!**

Fast spinning tires can be dangerous. Forces generated by excessive wheel speeds may cause damage, or even failure, of the axle and tires. A tire could explode and injure someone. Do not spin your vehicle's wheels faster than 30 mph (48 km/h) or for longer than 30 seconds continuously without stopping when you are stuck and do not let anyone near a spinning wheel, no matter what the speed.

# WHAT TO DO IN EMERGENCIES

## EVENT DATA RECORDER (EDR)

- This vehicle is equipped with an event data recorder (EDR). The main purpose of an EDR is to record, in certain crash or near crash-like situations, such as an air bag deployment or hitting a road obstacle, data that will assist in understanding how a vehicle's systems performed. The EDR is designed to record data related to vehicle dynamics and safety systems for a short period of time, typically 30 seconds or less. The EDR in this vehicle is designed to record such data as:
  - How various systems in your vehicle were operating;
  - Whether or not the driver and passenger safety belts were buckled/fastened;
  - How far (if at all) the driver was depressing the accelerator and/or brake pedal; and,
  - How fast the vehicle was traveling.
- These data can help provide a better understanding of the circumstances in which crashes and injuries occur.

**NOTE:** EDR data are recorded by your vehicle only if a non-trivial crash situation occurs; no data are recorded by the EDR under normal driving conditions and no personal data (e.g. name, gender, age, and crash location) are recorded. However, other parties, such as law enforcement, could combine the EDR data with the type of personally identifying data routinely acquired during a crash investigation.

- To read data recorded by an EDR, special equipment is required, and access to the vehicle or the EDR is needed. In addition to the vehicle manufacturer, other parties such as law enforcement, that have the special equipment, can read the information if they have access to the vehicle or the EDR.

# MAINTAINING YOUR VEHICLE

## OPENING THE HOOD



- Release the two hood latches located on the left and right side of the hood.
- Raise the hood and locate the safety latch, in the middle of the hood opening.
- Push the latch to the left side of the vehicle, to open the hood. You may have to push down slightly on the hood before pushing the safety latch.
- Insert the support rod into the slot on the hood.
- To close the hood, remove the support rod and place it in the retaining clip, then lower the hood slowly.
- Secure both of the hood latches.

### **WARNING!**

Be sure the hood is fully latched before driving your vehicle. If the hood is not fully latched, it could open when the vehicle is in motion and block your vision. Failure to follow this warning could result in serious injury or death.

# MAINTAINING YOUR VEHICLE

## ENGINE COMPARTMENT

### 3.6L Engine



# MAINTAINING YOUR VEHICLE

## FLUIDS AND CAPACITIES

Component	Fluid, Lubricant, or Genuine Part	Capacities
Engine Coolant 3.6L	MOPAR® Antifreeze/ Coolant 5 Year/100,000 Mile Formula HOAT (Hybrid Organic Additive Technology) or equivalent.	10.5 Quarts (9.9 Liters) Includes coolant recovery bottle filled to MAX level.
Engine Oil with filter 3.6L	Use API Certified SAE 5W-30 Engine Oil, meeting the requirements of Chrysler Material Standard MS-6395. Refer to your engine oil filler cap for correct SAE grade.	6 quarts (5.7 Liters)
Fuel Selection 2 Door	87 Octane	18.6 Gallons (70 Liters) (Approximate)
Fuel Selection 4 Door	87 Octane	22.5 Gallons (85 Liters) (Approximate)
Engine Oil Filter 3.6L	MOPAR® Engine Oil Filter or equivalent.	—
Spark Plug 3.6L	RER8ZWYCB4 (Gap 0.043 in [1.1 mm])	—
Automatic Transmission	MOPAR® ATF+4® Automatic Transmission Fluid or equivalent licensed ATF+4® product.	—
Manual Transmission	MOPAR® Manual Transmission Lubricant or equivalent (meeting the requirements of Chrysler Material Standard MS-9224).	—
Transfer Case	MOPAR® Manual Transmission Lubricant or equivalent (meeting the requirements of Chrysler Material Standard MS-9224).	—
Axle differential (front)	MOPAR® Gear & Axle Lubricant (SAE 80W-90) (API GL-5) or equivalent.	—



# MAINTAINING YOUR VEHICLE

Component	Fluid, Lubricant, or Genuine Part	Capacities
Axle differential (rear)	<b>226 RBI (Model 44)</b> - MOPAR® Gear & Axle Lubricant (SAE 80W-90) (API GL-5) or equivalent. For trailer towing, use MOPAR® Synthetic Gear & Axle Lubricant (SAE 75W-140) or equivalent. Models equipped with Trac-Lok™ require an additive.	—
Brake Master Cylinder	MOPAR® DOT 3 Brake Fluid, SAE J1703 should be used. If DOT 3, SAE J1703 brake fluid is not available, then DOT 4 is acceptable. Use only recommended brake fluids.	—
Power Steering Reservoir	MOPAR® Power Steering Fluid +4, MOPAR® ATF+4® Automatic Transmission Fluid or equivalent licensed ATF+4® product.	—

# MAINTAINING YOUR VEHICLE

## MAINTENANCE CHART

Miles:	8,000	16,000	24,000	32,000	40,000	48,000	56,000	64,000	72,000	80,000	88,000	96,000	104,000
Or Months:	6	12	18	24	30	36	42	48	54	60	66	72	78
Or Kilometers:	13,000	26,000	39,000	52,000	65,000	78,000	91,000	104,000	117,000	130,000	143,000	156,000	169,000
Change the engine oil and engine oil filter.	X	X	X	X	X	X	X	X	X	X	X	X	X
Rotate the tires, rotate at the first sign of irregular wear, even if it occurs before scheduled maintenance.	X	X	X	X	X	X	X	X	X	X	X	X	X
If using your vehicle for any of the following: dusty or off-road conditions. Inspect the engine air cleaner filter; replace if necessary.		X				X				X			
Inspect the brake linings; replace if necessary.		X		X		X		X		X		X	
Inspect the CV joints.			X			X			X			X	
Inspect the exhaust system.		X	X			X			X			X	
Replace the engine air cleaner filter.			X			X		X				X	
Inspect the transfer case fluid.				X									
Change the transfer case fluid if using your vehicle for police, taxi, fleet, or frequent trailer towing.								X				X	
Inspect the front and rear axle fluid. Change if using your vehicle for police, taxi, fleet, off-road or frequent trailer towing.			X			X			X			X	
Adjust the parking brake on vehicles equipped with four wheel disc brakes.				X				X				X	
Change the automatic transmission fluid and filter if using your vehicle for any of the following: police, taxi, fleet or frequent trailer towing.								X					

# MAINTAINING YOUR VEHICLE

Miles: Or Months: Or Kilometers:	8,000	16,000	24,000	32,000	40,000	48,000	56,000	64,000	72,000	80,000	88,000	96,000	104,000
	6	12	18	24	30	36	42	48	54	60	66	72	78
	13,000	26,000	39,000	52,000	65,000	78,000	91,000	104,000	117,000	130,000	143,000	156,000	169,000
Change the manual transmission fluid if using your vehicle for any of the following: trailer towing, snow plowing, heavy loading, taxi, police, delivery service (commercial service), off-road, desert operation or more than 50% of your driving is at sustained high speeds during hot weather, above 90°F (32 °C).				X				X				X	
Flush and replace the engine coolant if not done at 104,000 miles (169000 km).										X			X
Inspect front suspension, tie rod ends, and boot seals; replace if necessary.		X		X		X		X		X		X	
Replace the ignition cables.												X	
Replace the spark plugs.												X	
Inspect and replace PCV valve if necessary.												X	
Inspect all door latches for presence of grease - reapply as necessary.	X	X	X	X	X	X	X	X	X	X	X	X	X

- Refer to the Owner's Manual on the DVD for complete maintenance schedule.

# MAINTAINING YOUR VEHICLE

## Maintenance Record

	Odometer	Date	Signature, Authorized Service Center
8,000 Miles (13,000 km) or 6 Months			
16,000 Miles (26,000 km) or 12 Months			
24,000 Miles (39,000 km) or 18 Months			
32,000 Miles (52,000 km) or 24 Months			
40,000 Miles (65,000 km) or 30 Months			
48,000 Miles (78,000 km) or 36 Months			
56,000 Miles (91,000 km) or 42 Months			
64,000 Miles (104,000 km) or 48 Months			
72,000 Miles (117,000 km) or 54 Months			
80,000 Miles (130,000 km) or 60 Months			
88,000 Miles (143,000 km) or 66 Months			
96,000 Miles (156,000 km) or 72 Months			
104,000 Miles (169,000 km) or 78 Months			

# MAINTAINING YOUR VEHICLE

## FUSES

### Integrated Power Module (fuses)

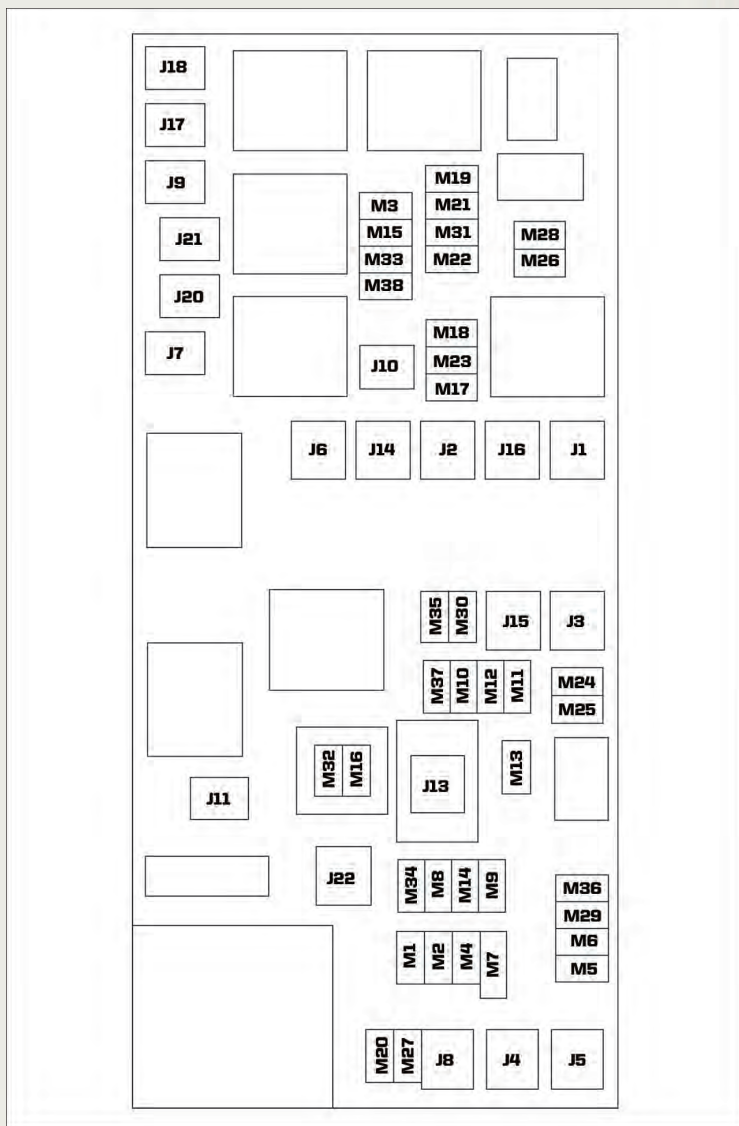

# MAINTAINING YOUR VEHICLE

- The Integrated Power Module is located in the engine compartment near the battery. This center contains cartridge fuses, mini-fuses and relays.

Cavity	Cartridge Fuse	Mini Fuse	Description
J1	—		—
J2	30 Amp Pink		Transfer Case Module
J3	—		—
J4	25 Amp Natural		Driver Door Node
J5	25 Amp Natural		Passenger Door Node
J6	40 Amp Green		Anti-Lock Brake System (ABS) Pump Feed/ESP
J7	30 Amp Pink		Anti-Lock Brake System (ABS) Valve Feed/ESP
J8	—		—
J9	40 Amp Green		PZEV Sec Motor Feed/Flex Fuel
J10	30 Amp Pink		Headlamp Wash Relay/Manifold Tuning Valve
J11	30 Amp Pink		Sway Bar
J13	60 Amp Yellow		Ignition Off Draw (IOD) — Main
J14	40 Amp Green		EBL (Rear Window Defogger)
J15	40 Amp Green		Front Blower
J17	40 Amp Green		Starter Solenoid
J18	20 Amp Blue		Powertrain Control Module (PCM) Trans Range
J19	60 Amp Yellow		Radiator Fan
J20	30 Amp Pink		Front Wiper LO/HI
J21	20 Amp Blue		Front/Rear Washer
J22	—		Spare
M1		15 Amp Blue	Center High-Mounted Stop Light (CHMSL)/Switch Stop Lamp Feed
M2		20 Amp Yellow	Relay Trailer Lighting (Stop)
M3		20 Amp Yellow	Frt/Rear Axle Locker Relay
M4		—	—
M5		25 Amp Natural	Power Inverter - If Equipped

# MAINTAINING YOUR VEHICLE

<b>Cavity</b>	<b>Cartridge Fuse</b>	<b>Mini Fuse</b>	<b>Description</b>
M6		20 Amp Yellow	Power Outlet #1/Rain Sensor
M7		20 Amp Yellow	Power Outlet #2 (BATT/ACC SELECT)
M8		20 Amp Yellow	Front Heated Seat
M9		20 Amp Yellow	Rear Heated Seat (If Equipped)
M10		15 Amp Blue	Ignition Off Draw – Vehicle Entertainment System (IOD-VES), Satellite Digital Audio Receiver (SDARS), DVD, Hands-Free Module (HFM), RADIO, Antenna (ANT), Universal Garage Door Opener (UGDO), Vanity Lamp (VANITY LP)
M11		10 Amp Red	(Ignition Off Draw) IOD-HVAC/ATC, MW SENSR, Underhood Lamp (UH LMP)
M12		30 Amp Green	Amplifier (AMP)
M13		20 Amp Yellow	Ignition Off Draw— Cabin Compartment Node (IOD-CCN), Wireless Control Module (WCM), SIREN, Multifunction Control Switch (MULTIFCTN SW)
M14		20 Amp Yellow	Trailer Tow (Export Only)
M15		20 Amp Yellow	COL MOD, IR SNS, Heater Ventilation, Air Conditioning/ Automatic Temperature Control (HVAC/ATC), Rear View Mirror (RR VW MIR), Cabin Compartment Node (CCN), Transfer Case Switch (T-CASE SW), RUN/ST, Multi-Function Control Switch (MULTIFCTN SW), Tire Pressure Monitor (TPM), Glow Plug Module (GLW PLG MOD) – Export Diesel Only
M16		10 Amp Red	Occupant Restraint Controller (ORC)
M17		15 Amp Blue	Left Tail/License/Park Lamp (LT-TAIL/LIC/PRK LMP)

# MAINTAINING YOUR VEHICLE

<b>Cavity</b>	<b>Cartridge Fuse</b>	<b>Mini Fuse</b>	<b>Description</b>
M18		15 Amp Blue	Right Tail/Park/Run Lamp (RT-TAIL/PRK/RUN LMP)
M19		25 Amp Natural	Auto Shut Down (ASD #1 and #2)
M20		15 Amp Blue	Cabin Compartment Node Interior Light (CCN INT LIGHT), Switch Bank (SW BANK)
M21		20 Amp Yellow	Auto Shut Down (ASD #3)
M22		10 Amp Red	Right Horn (RT HORN (HI/LOW))
M23		10 Amp Red	Left Horn (LT HORN (HI/LOW))
M24		25 Amp Natural	Rear Wiper (REAR WIPER)
M25		20 Amp Yellow	Fuel Pump (FUEL PUMP), Diesel Lift Pump (DSL LIFT PUMP) — Export Only
M26		10 Amp Red	Power Window Switch/Driver Window Switch
M27		10 Amp Red	Ignition Switch Feed, Wireless Module
M28		10 Amp Red	PCM Feed/TCM
M29		10 Amp Red	Powertrain
M30		15 Amp Blue	Wiper Motor Frt, J1962 Diagnostic Feed
M31		20 Amp Yellow	Backup Lamps (B/U LAMPS)
M32		10 Amp Red	Occupant Restraint Controller (ORC), TT EUROPE
M33		10 Amp Red	Next Generation Controller (NGC), Global Powertrain Engine Controller (GPEC)
M34		10 Amp Red	Park Assist (PRK ASST), Heater Ventilation, Air Conditioning Module (HVAC MOD), Headlamp Wash (HDLP WASH), Compass (COMPAS)
M35		10 Amp Red	Heated Mirrors
M36		20 Amp Yellow	Power Outlet
M37		10 Amp Red	Anti-Lock Brake System (ABS), Electronic Stability Program (ESP), Stop Lamp Switch (STP LP SW), Fuel Pump Rly Hi Control



# MAINTAINING YOUR VEHICLE

Cavity	Cartridge Fuse	Mini Fuse	Description
M38		25 Amp Natural	Lock/Unlock Motors (LOCK/UNLOCK MTRS)

## TIRE PRESSURES

- Check the inflation pressure of each tire, including the spare tire, at least monthly and inflate to the recommended pressure for your vehicle.
- The tire pressures recommended for your vehicle are found on the “Tire and Loading Information” label located on the driver’s side door opening.

### 2 Door Tire Placard Location



### 4 Door Tire Placard Location

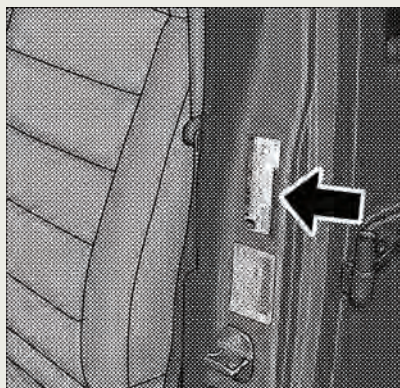

**NOTE:** Refer to the Owner’s Manual on the DVD for more information regarding tire warnings and instructions.

# MAINTAINING YOUR VEHICLE

## WARNING!

- Overloading of your tires is dangerous. Overloading can cause tire failure, affect vehicle handling, and increase your stopping distance. Use tires of the recommended load capacity for your vehicle. Never overload them.
- Improperly inflated tires are dangerous and can cause collisions. Under-inflation is the leading cause of tire failure and may result in severe cracking, component separation, or “blow out”. Over-inflation reduces a tire’s ability to cushion shock. Objects on the road and chuck holes can cause damage that results in tire failure. Unequal tire pressures can cause steering problems. You could lose control of your vehicle. Over-inflated or under-inflated tires can affect vehicle handling and can fail suddenly, resulting in loss of vehicle control.

## WHEEL AND WHEEL TRIM CARE

- All wheels and wheel trim, especially aluminum and chrome plated wheels, should be cleaned regularly with a mild soap and water to prevent corrosion.
- To remove heavy soil and/or excessive brake dust, use MOPAR® Wheel Cleaner or equivalent or select a non-abrasive, non-acidic cleaner.

## CAUTION!

Do not use scouring pads, steel wool, a bristle brush, or metal polishes. Do not use oven cleaner. These products may damage the wheel’s protective finish. Avoid automatic car washes that use acidic solutions or harsh brushes that may damage the wheel’s protective finish. Only MOPAR® Wheel Cleaner or equivalent is recommended.

## EXTERIOR BULBS

Bulb Number	LIGHT BULBS - Exterior
3157	Backup, Tail, Stop, Turn Lamp
LED (*)	Center High-Mounted Stop Lamp (CHMSL)
PSX24W	Fog Lamp - If Equipped
3157	Front Park/Turn Signal
168	Front Side Marker
H13	Headlamp - Low Beam
194	License Lamp

\* CHMSL is not serviceable. It is a LED lamp. To replace the LED, the entire CHMSL assembly must be replaced.

# CONSUMER ASSISTANCE

## CHRYSLER GROUP LLC CUSTOMER CENTER

P.O. Box 21-8004

Auburn Hills, MI 48321-8004

Phone: 1-877-426-5337

## CHRYSLER CANADA INC. CUSTOMER CENTER

P.O. Box 1621

Windsor, Ontario N9A 4H6

Phone: 1-800-465-2001 (English)

Phone: 1-800-387-9983 (French)

## ASSISTANCE FOR THE HEARING IMPAIRED

- To assist customers who have hearing difficulties, the manufacturer has installed special TDD (Telecommunication Devices for the Deaf) equipment at its customer center. Any hearing or speech impaired customer, who has access to a TDD or a conventional teletypewriter (TTY) in the United States, can communicate with the manufacturer by dialing 1-800-380-CHRY. Canadian residents with hearing difficulties that require assistance can use the special needs relay service offered by Bell Canada. For TTY teletypewriter users, dial 711 and for Voice callers, dial 1-800-855-0511 to connect with a Bell Relay Service operator.

### WARNING!

Engine exhaust, some of its constituents, and certain vehicle components contain, or emit, chemicals known to the State of California to cause cancer and birth defects, or other reproductive harm. In addition, certain fluids contained in vehicles and certain products of component wear contain, or emit, chemicals known to the State of California to cause cancer and birth defects, or other reproductive harm.

## PUBLICATIONS ORDERING

- **If you are the first registered retail owner of your vehicle**, you may obtain one free printed copy of the Owner's Manual, Warranty Booklet or Radio Manuals on your DVD by calling 1-877-426-5337 (U.S.) or 1-800-387-1143 (Canada) or by contacting your dealer.
- Replacement User Guide kits or DVDs or, if you prefer, additional printed copies of the Owner's Manual, Warranty Booklet or Radio Manuals may be purchased by visiting [www.techauthority.com](http://www.techauthority.com) or by calling 1-800-890-4038 (U.S.) or 1-800-387-1143 (Canada). Visa, Master Card, American Express and Discover orders are accepted. If you prefer mailing your order, please call the above numbers for an order form.

**NOTE:** A street address is required when ordering manuals (no P.O. Boxes).

# CONSUMER ASSISTANCE

## NOTE:

- The Owner's Manual and User Guide electronic files are also available on the Chrysler, Jeep, Ram Truck and Dodge websites.
- Click on the "For Owners" tab, select "Owner/Service Manuals", then select your desired model year and vehicle from the drop-down lists.

## REPORTING SAFETY DEFECTS IN THE 50 UNITED STATES AND WASHINGTON, D.C.

- If you believe that your vehicle has a defect that could cause a collision or cause injury or death, you should immediately inform the National Highway Traffic Safety Administration (NHTSA) in addition to notifying the manufacturer.
- If NHTSA receives similar complaints, it may open an investigation, and if it finds that a safety defect exists in a group of vehicles, it may order a recall and remedy campaign. However, NHTSA cannot become involved in individual problems between you, your authorized dealer, and the manufacturer.
- To contact NHTSA, you may either call the Auto Safety Hotline toll free at 1-888-327-4236 (TTY: 1-800-424-9153), or go to <http://www.safercar.gov>; or write to: Administrator, NHTSA, 1200 New Jersey Avenue, SE., West Building, Washington, D.C. 20590. You can also obtain other information about motor vehicle safety from <http://www.safercar.gov>.

## In Canada

- If you believe that your vehicle has a safety defect, you should contact the Customer Service Department immediately. Canadian customers who wish to report a safety defect to the Canadian government should contact Transport Canada, Motor Vehicle Defect Investigations and Recalls at 1-800-333-0510 or go to <http://www.tc.gc.ca/roadsafety/>
- French Canadian customers who wish to report a safety defect to the Canadian government should contact Transport Canada, Motor Vehicle Defect Investigations and Recalls at 1-800-333-0510 or go to <http://www.tc.gc.ca/securiteroutiere/>

# MOPAR ACCESSORIES

## AUTHENTIC ACCESSORIES BY MOPAR®

- The following highlights just some of the many Authentic Jeep Accessories by Mopar featuring a fit, finish, and functionality specifically for your Jeep Wrangler.
- In choosing Authentic Accessories you gain far more than expressive style, premium protection, or extreme entertainment, you also benefit from enhancing your vehicle with accessories that have been thoroughly tested and factory-approved.
- For the full line of Authentic Jeep Accessories by Mopar, visit your local Jeep dealership or online at [mopar.com](http://mopar.com).

### Chrome:

- Grille
- Mirror Covers
- Door Handle Covers
- Tubular Side Steps
- Fuel Door
- Door Hinge Covers
- Tubular Bumper
- Tail Lamp Guards

### Off Road:

- Off Road Bumpers
- Winches
- Exhaust
- Rock Rails
- Lift Kits
- Skid Plates
- Off Road Lights

### Exterior:

- Black Tubular Side Steps
- Front End Cover
- Air Deflectors
- Soft Tops
- Hard Top Storage Dolly
- Black Tubular Bumpers
- Cab Covers
- Wheels
- Splash Guards
- Running Boards
- Spare Tire Covers
- Hard Tops
- Fender Flares

### Interior:

- Premium Carpet Floor Mats
- Seat Covers
- Slush Floor Mats
- Instrument Panel Appliques
- Door Sill Guards

### Electronics:

- Portable Navigation Systems
- Heated Seats
- Fog Lights
- Uconnect™ Web (WiFi)
- Ambient Footwell Lighting
- Electronic Vehicle Tracking System
- Sirius Satellite Radio
- iPod® Adapter

# MOPAR ACCESSORIES

**Carriers:**

- Freedom Top Carriers
- Spare Tire-mount Ski
- Hitch Receivers and Trailing Accessories
- Bike Carriers

iPod® is a registered trademark of Apple, Inc.

# INDEX

- Air Conditioning . . . . . 22
- Airbag . . . . . 10
- Alarm, Panic . . . . . 8
- Antifreeze (Engine Coolant) . . . . . 94
- Arming Theft System (Security Alarm) . . . . . 9
- Audio Settings . . . . . 32,33,34,36,37,38,42,52
- Automatic Headlights . . . . . 18
- Automatic Temperature Control (ATC) . . . . . 22
  
- Belts, Seat . . . . . 9
- Break-In Recommendations, New Vehicle . . . . . 18
- Bulb Replacement . . . . . 104
  
- Calibration, Compass . . . . . 66
- Capacities, Fluid . . . . . 94
- Change Oil Indicator . . . . . 80
- Changing A Flat Tire . . . . . 82
- Child Restraint . . . . . 11
- Child Restraint Tether Anchors . . . . . 11
- Climate Control . . . . . 22
- Clock Setting . . . . . 32,34,37,39,49
- Compass Calibration . . . . . 66
- Cooling System
  - Coolant Capacity . . . . . 94
  - Selection of Coolant (Antifreeze) . . . . . 94
- Cruise Control (Speed Control) . . . . . 20
- Cruise Light . . . . . 20
- Customer Assistance . . . . . 105
  
- Defects, Reporting . . . . . 106
- Dimmer Control . . . . . 18
- Dimmer Switch, Headlight . . . . . 18
- Disarming, Theft System . . . . . 9
  
- ECO . . . . . 67
- Electronic Speed Control (Cruise Control) . . . . . 20
- Electronic Vehicle Information Center (EVIC) . . . . . 66,67
- Electronics
  - Your Vehicle's Sound System . . . . . 30
  
- Emergency, In Case of
  - Jacking . . . . . 82
  - Overheating . . . . . 81
- Engine
  - Break-In Recommendations . . . . . 18
  - Compartment . . . . . 93
  - Fuel Requirements . . . . . 94
  - Oil . . . . . 94
  - Oil Selection . . . . . 94
  - Overheating . . . . . 81
- Event Data Recorder . . . . . 91
- Exterior Lights . . . . . 104
  
- Flash-To-Pass . . . . . 19
- Fluid Capacities . . . . . 94
- Fluids, Lubricants and
  - Genuine Parts . . . . . 94
  - Fog Lights . . . . . 18,19
  - Folding Rear Seat . . . . . 15
  - Freeing A Stuck Vehicle . . . . . 89
  - Front Heated Seats . . . . . 16
- Fuel
  - Requirements . . . . . 94
  - Tank Capacity . . . . . 94
  
- Hard Top . . . . . 27
- Headlights
  - Automatic . . . . . 18
  - Dimmer Switch . . . . . 18
  - High Beam . . . . . 19
- Heated Mirrors . . . . . 21,22
- Heated Seats . . . . . 16
- High Beam/Low Beam Select (Dimmer) Switch . . . . . 19
- Hood Release . . . . . 92
  
- Instrument Cluster . . . . . 6
  - Indicators . . . . . 7
- Instrument Cluster Warning Lights . . . . . 6,77
- Integrated Power Module (Fuses) . . . . . 99
- Intermittent Wipers (Delay Wipers) . . . . . 19
- Introduction . . . . . 2
- Inverter Outlet (115V) . . . . . 68
- Inverter, Power . . . . . 68

# INDEX

- iPod®/USB/MP3 Control . . . . . 60
  - Bluetooth Streaming Audio . . . 66
- Jack Location . . . . . 82
- Jack Operation . . . . . 82,83
- Jacking Instructions . . . . . 83
- Jump Starting . . . . . 86
- Key Fob . . . . . 8
- Key Fob Programmable Features . . . . . 67
- Lane Change Assist . . . . . 19
- LATCH (Lower Anchors and Tether for CHildren) . . . . . 11
- Lights
  - Turn Signal . . . . . 19
  - Warning (Instrument Cluster Description) . . . . . 6
- Maintenance Record . . . . . 98
- Maintenance Schedule . . . . . 96
- Media Center Radio . . . . . 32,34,36
- Mirrors
  - Heated . . . . . 21,22
- Navigation . . . . . 45,55
- New Vehicle Break-In Period . . . 18
- Oil Change Indicator . . . . . 80
- Oil, Engine
  - Capacity . . . . . 94
  - Recommendation . . . . . 94
  - Viscosity . . . . . 94
- Outlet
  - Power . . . . . 68
- Overheating, Engine . . . . . 81
- Panic Alarm . . . . . 8
- Phone (Pairing) . . . . . 61
- Phone (Uconnect) . . . . . 60
- Placard, Tire and Loading Information . . . . . 103
- Power
  - Inverter . . . . . 68
  - Outlet (Auxiliary Electrical Outlet) . . . . . 68
- Preparation for Jacking . . . . . 82
- Programmable Electronic Features . . . . . 67
- Radio Operation . . . . . 39,48
- Rain Sensitive Wiper System . . . 19
- Rear Seat, Folding . . . . . 15
- Recreational Towing . . . . . 74
  - Shifting into Transfer Case Neutral (N) . . . . . 74
  - Shifting out of Transfer Case Neutral (N) . . . . . 75
- Remote Starting System . . . . . 8
- Replacement Bulbs . . . . . 104
- Reporting Safety Defects . . . . 106
- Restraints, Child . . . . . 11
- Roll Over Warning . . . . . 3
- Seat Belts . . . . . 9
- Seats . . . . . 13
  - Adjustment . . . . . 13
  - Easy Entry . . . . . 14
  - Heated . . . . . 16
  - Rear Folding . . . . . 15
- Seek Button . . . . . 32,33,35,37,38
- Setting the Clock . . . 32,34,37,39,49
- Shift Lever Override . . . . . 89
- Shifting
  - Transfer Case, Shifting into Transfer Case Neutral (N) . . . . 74
  - Transfer Case, Shifting out of Transfer Case Neutral (N) . . . . 75
- Signals, Turn . . . . . 19
- SIRIUS Travel Link . . . . . 58
- Soft Top . . . . . 23
- Spare Tire . . . . . 82
- Speed Control (Cruise Control) . 20
- Starting
  - Remote . . . . . 8
- Steering
  - Tilt Column . . . . . 16
- Steering Wheel Audio Controls . 59
- Store Radio Presets . . . . . 33,35,37
- Stuck, Freeing . . . . . 89
- Supplemental Restraint System - Airbag . . . . . 10
- Sway Bar Disconnect, Electronic . 71



# INDEX

- Temperature Control, Automatic (ATC) . . . . . 22
- Temperature Gauge, Engine Coolant . . . . . 82
- Theft Alarm (Security Alarm) . . . . . 9
- Theft System Arming . . . . . 9
- Theft System Disarming . . . . . 9
- Tilt Steering Column . . . . . 16
- Tires
  - Air Pressure . . . . . 103
  - Changing . . . . . 82
  - Jacking . . . . . 82,83
  - Pressure Warning Light . . . . . 77
  - Spare Tire . . . . . 82
- Tow Hooks, Emergency . . . . . 88
- Towing . . . . . 72
  - 24-Hour Towing Assistance . . . . . 77
  - Disabled Vehicle . . . . . 89
  - Recreational . . . . . 74
- Trailer Towing
  - Trailer and Tongue Weight . . . . . 72
  - Trailer Weight . . . . . 72
  - Turn Signals . . . . . 19
- Uconnect™ Phone . . . . . 60
- Uconnect™ Voice Command . . . . . 63
- Voice Command . . . . . 63
- Warning, Roll Over . . . . . 3
- Washer
  - Rear . . . . . 20
- Washers, Windshield . . . . . 19
- Wheel and Wheel Trim Care . . . . . 104
- Wind Buffeting . . . . . 29
- Windshield Washers . . . . . 19
- Windshield Wipers . . . . . 19
- Wiper, Rear . . . . . 20

# FAQ (How To?)

## FREQUENTLY ASKED QUESTIONS

### GETTING STARTED

- How do I install my LATCH Equipped Child Seat? pg. 11
- How do I adjust the height of my Front Seat? pg. 13

### OPERATING YOUR VEHICLE

- How do I operate my Soft Top? pg. 23
- How do I operate my Hard Top? pg. 27

### ELECTRONICS

- Which radio is in my vehicle? pg. 32, 34, 36, 39, 48
- How do I activate the Audio Jack? pg. 33, 36, 38, 42, 52
- How do I set the clock on my radio? pg. 32, 34, 37, 39, 49
- How do I use the Navigation feature? pg. 55
- How do I pair my cell phone via Bluetooth® with the UConnect™ Hands-Free Voice Activation System? pg. 60
- How do I use my iPod®? pg. 60
- How do I use my USB port to listen to audio through my touch-screen radio? pg. 60
- What does the ECO message mean on the EVIC display? pg. 67

### OFF-ROAD CAPABILITIES

- How do I shift into different four-wheel drive selections? pg. 70

### UTILITY

- How do I know how much I can tow with my Jeep Wrangler? pg. 72

### WHAT TO DO IN EMERGENCIES

- What do I do if my TPMS warning light is blinking? pg. 77
- How do I change a flat tire? pg. 82
- How do I Jump-Start my vehicle? pg. 86

### MAINTAINING YOUR VEHICLE

- Where is my Fuse Block located? pg. 99
- What type of oil do I use? pg. 94
- How often should I change my engine's oil? pg. 96
- What should my tire pressure be set at? pg. 103



This guide has been prepared to help you get quickly acquainted with your new Jeep and to provide a convenient reference source for common questions. However, it is not a substitute for your Owner's Manual.

For complete operational instructions, maintenance procedures and important safety messages, please consult your Owner's Manual, Navigation/Media Center Manuals and other Warning Labels in your vehicle.

Not all features shown in this guide may apply to your vehicle. For additional information on accessories to help personalize your vehicle, visit [www.mopar.com](http://www.mopar.com) or your local Jeep dealer.



## Driving and Alcohol:

Drunken driving is one of the most frequent causes of collisions. Your driving ability can be seriously impaired with blood alcohol levels far below the legal minimum. If you are drinking, don't drive. Ride with a designated non-drinking driver, call a cab, a friend, or use public transportation.

### **WARNING!**

Driving after drinking can lead to a collision. Your perceptions are less sharp, your reflexes are slower, and your judgment is impaired when you have been drinking. Never drink and then drive.



12JK72-926-AA  
Wrangler  
First Edition  
User Guide

**Download a FREE electronic copy**  
of the Owner's Manual or Warranty  
Booklet by visiting the For Owners tab at:  
[www.Jeep.com](http://www.Jeep.com) (U.S.) or  
[www.Jeep.ca](http://www.Jeep.ca) (Canada).

[Jeep.com](http://Jeep.com)